



Cobb Broiler

Management Guide

www.cobb-vantress.com

01	——	Biosecurity and Farm Sanitation	2	08	——	Energy Efficient House Design	52
	1.1	Farm Biosecurity.....	2		8.1	Roof Design and Insulation.....	53
	1.2	Farm Sanitation.....	3		8.2	Curtain Installation.....	54
	1.3	Vaccinations.....	6		8.3	Perimeter Inlet Installation.....	55
02	——	House Preparation - Pre-placement	11		8.4	Horizontal and Vertical Circulation Fan Systems.....	57
	2.1	Stocking Density.....	11		8.5	Tunnel Door Design.....	59
	2.2	Brooding Chamber.....	12		8.6	Evaporative Pad Design.....	60
	2.3	Housing Configuration for Brooding.....	13		8.7	Fogging Systems.....	62
	2.4	Drinker Systems.....	16		8.8	Water Systems.....	64
	2.5	Feeding Systems.....	19	09	——	Ventilation Management	67
	2.6	Heating Systems.....	21		9.1	Minimum Ventilation.....	68
	2.7	Litter Management.....	22		9.2	Fans Required for Minimum Ventilation.....	70
	2.8	Pre-Placement Checklist.....	25		9.3	Negative Pressure - Key Requirement for Minimum Ventilation.	71
03	——	Chick Placement	30		9.4	Perimeter Inlet Management.....	72
	3.1	Key Placement Requirements.....	30		9.5	Simple Negative Pressure Test.....	73
	3.2	Chick Quality.....	30		9.6	Transition Ventilation.....	73
	3.3	Brooding Management.....	33		9.7	Tunnel Ventilation.....	75
04	——	Post Placement	35		9.8	Evaporative Cooling.....	79
	4.1	Post Placement Management.....	35		9.9	Natural Ventilation.....	82
05	——	Growing Phase	38	10	——	Catching Procedures	85
	5.1	Uniformity.....	38	11	——	Record Keeping	91
	5.2	Temperature and Stocking Density Management.....	40	12	——	Appendices	94
	5.3	Lighting Programs.....	41			Measurements and Conversions	95
06	——	Nutrition Management	44			Broiler Farm Contacts	96
07	——	Water Management	47				
	7.1	Mineral Content.....	47				
	7.2	Microbial Contamination.....	49				
	7.3	Total Dissolved Solids.....	49				
	7.4	Drinking System Cleanout Between Flocks.....	50				
	7.5	Water Sanitation and System Cleanout.....	50				
	7.6	Water Testing.....	50				

Introduction

The Cobb commitment to genetic improvement continues to increase the performance potential in all areas of broiler and broiler breeder production. However, to attain both genetic potential and consistent flock production, it is important that the flock manager has a good management program in place. The worldwide success of Cobb has provided knowledge and experience over a wide range of climatic conditions, controlled environment and open housing. The Cobb Broiler Management Guide is designed to assist you in developing your management program regardless of your housing or environmental conditions.

Management must meet the basic needs of the birds and be optimized to realize the breed's potential. Some guidelines may need to be adapted according to your local conditions and regulations with assistance from our technical teams.

The Cobb Broiler Management Guide is part of our technical information library, which includes Hatchery, Grand Parent, Breeder, Vaccination, and Processing Guides, Technical Supplements, articles, and a full range of performance charts.

Our recommendations are based on current scientific knowledge and practical experience from around the world. You should always be aware of local legislation, which may influence the management practices that you choose to adopt. The Cobb Broiler Management Guide is intended as a reference and supplement to your own flock management skills so that you can obtain consistent results from the Cobb family of products.



Animal Welfare Tips

Look for this **Cobb cares** symbol throughout the guide that highlights the Animal Welfare Tips and important aspects of management to improve poultry welfare outcomes.



The Cobb Broiler Management guide is available online under **Resources > Management Guides**

1

Biosecurity and Farm Sanitation

Biosecurity is the term used to describe an overall strategy or succession of measures employed to prevent infectious diseases from a production site. Maintaining an effective biosecurity program, using good hygiene practices and following a comprehensive vaccination program are all essential to disease prevention. A comprehensive biosecurity program involves a sequence of planning, implementing and control. Remember, it is impossible to sterilize a house or farm. The key to biosecurity success is to reduce the potential for pathogen introduction and prevent pathogen spread within a farm or to other farm premises.

1.1 Farm Biosecurity

Outlined below are key points to a successful biosecurity program

- ✓ Limit non-essential visitors to the farm. Keep a record of all approved visitors and their previous farm visits and/or bird contact. Have a minimum downtime requirement (ex: 72 hours) of “no bird contact” before visitors can enter the farm.
- ✓ Farm supervisors and technical staff should always visit younger flocks before older flocks. If visiting multiple farms in one day, schedule the youngest at the beginning of the day, and then visit other farms according to the chronological age of the birds. If visiting a farm with a suspect/known disease, technical staff and farm supervisors should not visit other farms to prevent transferring a disease pathogen to additional flocks.
- ✓ No contact with non-company poultry, particularly backyard poultry.
- ✓ If equipment must come from another farm, it must be thoroughly cleaned and disinfected before it comes onto the farm, and again upon arrival at the receiving farm.
- ✓ Provide wheel dips or wheel spraying facilities at the farm entrance. Allow only necessary vehicles on site.
- ✓ Farms should be fenced.
- ✓ Keep poultry house doors and farm gates locked at all times.
- ✓ Absolutely no other poultry should be kept on the same farm as your poultry unit. Farm animals other than poultry should be fenced separately and have a different entrance from the poultry farm enterprise.
- ✓ No pet animals should be allowed in or around the poultry housing.
- ✓ All farms should have a vermin control plan which includes frequent monitoring of rodent activity. Adequate supplies of rodent bait must be maintained in designated rodent control boxes.
- ✓ All houses should be vermin proof (rodent and wild birds).
- ✓ The area around the poultry house should be free from vegetation, debris and unused equipment that could harbor vermin.
- ✓ Clean up feed spills as quickly as possible and fix any leaking feed bins or feed pipes.
- ✓ Farms should have toilet and hand washing facilities separate from the poultry house.
- ✓ Ideally poultry farms should be built away from other poultry farms and away from rivers and ponds to limit any exposure to wild birds.

- ✓ If equipment needs to be brought onto the farm then it must be subjected to disinfection per the company's protocol for biosecurity.
- ✓ Best practice is to have feed delivered to a central bin from outside the farm perimeter fence and then using dedicated farm vehicles for moving the feed from the central bin to each house feed bin.
- ✓ A dedicated changing facility for protective clothing and footwear should be sited at the farm entrance. Ideally a 'shower on and shower off' policy is regarded as best practice. A timed five minute hot shower using the sanitizing agents is recommended.
- ✓ Provide hand-sanitizing facilities at the entrance to each house.
- ✓ Provide well-maintained footbaths at the entrance to each poultry house.
- ✓ Place all utility meters and equipment (e.g. gas, water and electric) outside of the farm to prevent utility trucks and personnel from entering the farm.
- ✓ Footbaths placed outside must have a lid to prevent dilution of disinfectant by rain and to prevent contamination from the environment.
- ✓ Clean footwear before using a footbath to remove organic material, which could inactivate the disinfectant.
- ✓ The disinfectant for the footbath should have a broad spectrum of activity and be fast acting.
- ✓ Incorporate a boot-change or boot cover system at the entry of each poultry house.
- ✓ Single-age broiler farms are highly recommended to reduce the risk of cycling of pathogens and/or vaccine agents within the farm.
- ✓ Chicks should be placed from similar age parent flocks of the same vaccination status.
- ✓ Depletion of birds must be complete before arrival of new chicks.
- ✓ Catching crews should be provided with protective clothing. Equipment such as coops/ crates and forklifts must be washed and disinfected before entering the farm, especially if partial depopulation is practiced.
- ✓ If cleaning out the farm and houses completely, an absolute minimum of 3 days must be observed from last disinfection on the farm to first placement of birds on a farm. Farms reusing litter require a minimum of 14 days downtime. If using an antibiotic-free program, increased downtime (ex: 18 days or more) is recommended to optimize bird health and well-being.
- ✓ If litter is re-used between flocks, all damp or caked litter should be removed and the ventilation and heating systems turned on in time to release any built up ammonia and to encourage drying of litter prior to placement of a new flock of chicks.
- ✓ Test water at least annually for mineral levels and microbial quality.
- ✓ Conduct frequent biosecurity audits at each farm, auditing the entire premises to ensure compliance with company expectations for cleaning, disinfection and biosecurity.

1.2 Farm Sanitation

The single most important factor in keeping poultry healthy is maintaining good hygiene. Healthy parent flocks and hygienic hatchery conditions contribute greatly to starting with disease-free chicks, but farm sanitation is critically important to maintaining a healthy broiler flock throughout the grow-out period. Farm sanitation does not just mean the choice of the right disinfectant. The key to farm sanitation is effective cleaning. Disinfectants will be inactivated by organic material. The following points are the basic steps for effective farm sanitation. However, not all of these steps are applicable when litter is re-used.

- ✓ Maintain the rodent control program after broiler catching.
- ✓ Remove all unused feed from the feed system, including all bins and augers.
- ✓ Carefully consider the health status of the depleted flock before moving the feed to another farm.
- ✓ Clean out all the litter from each house and remove it in covered vehicles.
- ✓ Clean all the dust and dirt from the building, paying special attention to less obvious places such as air inlets, fan boxes and the tops of walls and beams.
- ✓ Dry clean any equipment (e.g. electrical) that cannot be washed directly and cover it completely to protect it from the washing process.
- ✓ Open any drains and water runoff pathways. Wash all interior surfaces of the house and fixed equipment with a general detergent through a pressure washer. If using a foam or gel, use the recommended soaking time to give the product adequate time to work. Wash from the top to the bottom of the house (ceiling to the floor). If the fans are in the roof they should be washed before the ceiling.
- ✓ In curtain sided houses, thoroughly clean and disinfect the inside and outside of the curtain.
- ✓ Wash the house from one end to the other (paying special attention to fans and air inlets) working towards the end with the best water drainage. When complete there should be no standing water around the poultry house. Each farm must have adequate drainage that meets local environmental and legal requirements.
- ✓ Thoroughly but carefully clean house control rooms being conscious of electrical systems. This area can be cleaned with power air blowers, vacuums and wiping with a damp cloth. Always be aware of the dangers associated with working around power sources.
- ✓ If a water storage, vaccination, or header tank is present, open it and scrub it clean with a detergent.



- ✓ Drain the drinking system and header tank completely before adding cleaning solution.
- ✓ Removable equipment should be cleaned first with a detergent (or, if needed, a scale remover) and then thoroughly disinfected.
- ✓ Any equipment or materials such as a fiber chick guard or feeder lids that cannot be cleaned should not be reused for the next flock and should be safely disposed of.
- ✓ External areas such as gutters, fan boxes, roofs, pathways and concrete areas should be cleaned and maintained. Remove any washed out litter or organic matter from the farm compound. Unused equipment should be removed from the farm.
- ✓ Carry out any equipment or facility repairs and re-plug/fill any drains that were opened prior to and during washing.
- ✓ Outside concrete areas and ends of the house should be washed completely.
- ✓ Drying after disinfection is advantageous. Heat and/or fans can be used to speed drying.
- ✓ Staff areas, canteens, changing areas and offices should also be thoroughly cleaned. All footwear and clothing should be completely washed and disinfected.
- ✓ When choosing which disinfectant product to use, check the label to verify the environmental temperature(s) recommended for optimal product effectiveness. Also verify the efficacy of the product against bacteria and viruses of concern.
- ✓ Apply an effective broad-spectrum disinfectant through a pressure washer with a fan jet nozzle. Thoroughly soak all the interior surfaces and equipment working from top to bottom. Fan boxes, inlets, support beams and posts require special attention.
- ✓ After disinfection, biosecurity controls at house entrances must be reinstated.
- ✓ Adequate downtime between flocks will increase the effectiveness of the hygiene program.

To monitor the effectiveness of the sanitation program, a visual inspection and sampling for microbes is suggested. The effectiveness of the sanitation program can be measured using quantitative laboratory tests. Sterilizing the facilities is not realistic but microbiological monitoring can confirm that non-desired organisms such as *Salmonella* have been eliminated. A documented audit including microbiological monitoring and attention to the performance of subsequent flocks can help to determine the effectiveness and value of the sanitation program.

Swabbing to monitor cleaning and disinfection

The residual bacterial counts or total viable count (TVC), is used to monitor the effectiveness of the cleaning process. The maximum total viable count in colony forming units per cm² of floor area should not exceed 1,000 TVC and maximum 100 TVC for all other surfaces.

No *Salmonella* should be isolated after cleaning out procedure is completed

A minimum of ten swabs per house should be taken.

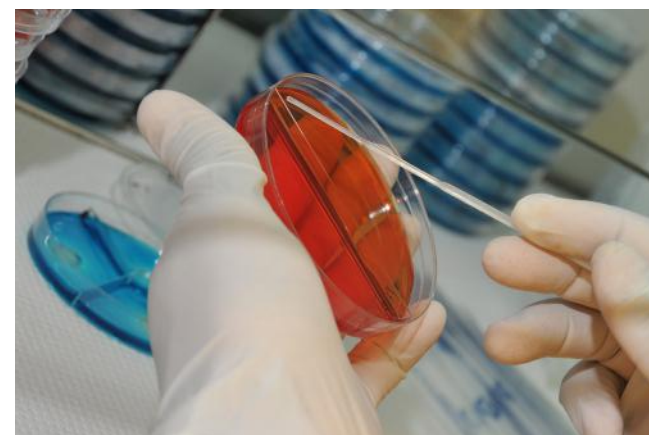

1.3 Vaccinations

Prevention is by far the most economical and best method of disease control. Disease prevention is best achieved by the implementation of an effective biosecurity program in conjunction with appropriate immunization. However, poultry diseases can overcome these precautions and when they do, it is important to prevent spread of the disease causing pathogen to other flocks/farms. Caretakers and service personnel should be trained to recognize signs of illness and problems that may be attributed to disease. These include changes in water and feed consumption patterns, sudden changes in fecal droppings appearance and litter conditions, excessive mortality, and irregular bird activity and/or flock behavior. Prompt action to address any problems is essential.

Broiler breeder flocks are vaccinated for a number of diseases to effectively pass on maternal antibodies to broiler chicks. These antibodies serve to protect the chicks during the early portion of the brooding period. However, these antibodies do not protect the broilers throughout the entire grow-out period. Therefore, it may be necessary to vaccinate the broilers either in the hatchery or in the field to prevent certain diseases. The timing of vaccinations should be based upon veterinary guidance, the level of expected maternal antibody, the disease in question and current field challenges.

The success of a broiler vaccination program is contingent upon correct administration of the vaccines. Specific recommendations for vaccine applications should be obtained from vaccine suppliers.

General vaccine handling procedures

- ✓ Ensure that vaccines are stored at the manufacturer's recommended temperature.
- ✓ Record vaccine product type, serial number and expiration date on pen charts or some other permanent flock record.
- ✓ Prepare vaccine and stabilizer mixture on a clean surface in clean containers free of any chemicals, disinfectants, cleaners or organic materials. (Use stabilizer only if directed by manufacturer of equipment and vaccine for the application method).
- ✓ Open each vial of vaccine while submerged under the water-stabilizer mixture.
- ✓ Rinse each vial of vaccine completely.

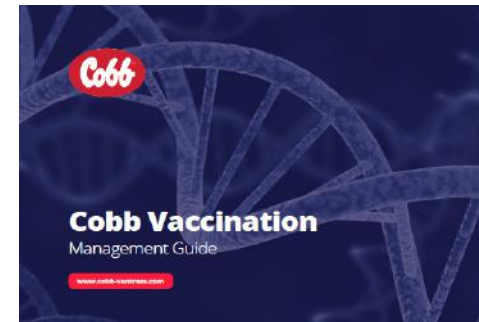

The Cobb Vaccination Management guide is available online at Cobb-Vantress.com under **Resources > Management Guides**

Hatchery vaccination guidelines

The hatchery has become a very important piece of the health program as many vaccines are administered either via in-ovo or at day of age. This allows a high number of embryos and chicks to be easily vaccinated against several poultry diseases using a uniform and accurate delivery system.

For years, spray vaccinations have been used at the hatchery for effective immunization against Infectious Bronchitis, Newcastle Disease, and Coccidiosis. Make sure to follow vaccine manufacturer recommendations to achieve the best immunization possible as recommendations differ among products and manufacturers.

Broilers that are placed on used litter and/or grown to heavy weights may require immunization against Marek's disease at the hatchery. This is done by injecting at least 1500 PFUs of the HVT (Herpes virus of turkeys) vaccine either *in-ovo* or on day of hatch.

HVT-vectored vaccines can also be administered at the hatchery as an aid to prevent Infectious Laryngotracheitis, Newcastle Disease, Infectious Bursal Disease, and Avian Influenza. It is important to note that HVT-vectored vaccines require the administration of a full dose so the vector virus and the inserted virus can reach the levels needed for proper immunization.



Field vaccination guidelines

Water vaccination

- ✓ Amount of water for vaccination should be calculated based on 90 to 120 minutes of vaccination time.
- ✓ Vaccinate early in the morning to reduce stress, especially in warm weather.
- ✓ Do not use water rich in metallic ions (e.g. iron and copper).
- ✓ Water pH should be 5.5 to 6.5. Water with a high pH can taste bitter to the birds which may reduce water and vaccine intake.
- ✓ Ensure rapid uptake of vaccine by withdrawing water a maximum of 1 hour before administration of vaccine begins.
- ✓ Using a vaccine manufacturer's approved dye or colored stabilizer may

help in determining when water lines are primed and how many birds have consumed vaccine.

- ✓ Turn off chlorinator 48 hours before administering the vaccine.
- ✓ Clean water filters 48 hours before vaccination to remove any chlorine residues. Clean filters using non-chlorinated water.
- ✓ Turn ultra-violet light off, if used, as this may inactivate the vaccine.
- ✓ Not all birds may receive the vaccine if a medicator is used.

Preparation of vaccines

1. Always follow manufacturer's directions. Calculate the required amount of water by using 30 % of the previous day's total consumed water. If no water meter is available, use the following calculation: Number of birds in thousands multiplied by their age in days multiplied by two. This equals the amount of water in liters needed to vaccinate over a 2-hour period.
2. Prepare a commercial stabilizer to neutralize any chlorine in the drinker lines per manufacturer's recommendations. Alternatively, mix 2.5 g (2 tsp) of powdered skimmed milk per liter (1.05 quarts) of water. Prepare skimmed milk solution 20 minutes before administering the vaccine to ensure the skimmed milk powder has neutralized any chlorine present in the water.
3. Prepare a dye solution for the water. The dye will be used to visually confirm the water contains the vaccine.

Nipple lines

1. Raise drinker lines.
2. Pour the prepared vaccine, stabilizer and color solution into the header tank or water storage tank.
3. Prime the lines until the stabilizer or dyed water comes through the far ends of the lines.
4. Lower drinker lines and allow birds to consume vaccine, making sure to turn water back on into the header tank just before the tank is empty.
5. Walk through the birds gently to encourage drinking and uniformity of application.
6. Record the vaccine consumption time in the records and any adjustments needed for next application of similar age birds and equipment to reach the ideal time of 90 to 120 minutes.

Field vaccination guidelines (cont.)

Bell drinker systems

1. Open the bell drinker system.
2. Two people are needed for the vaccination procedure. One person will mix the vaccine solution and the other will administer the vaccine.
3. Clean each drinker, emptying any water and litter. Do not use a disinfectant to clean the drinkers.
4. Carefully fill each drinker. Do not over fill the drinker or spill the mixed vaccine solution.
5. During vaccination, walk the house to encourage birds along the walls to get closer to the drinkers.

Monitoring water vaccination intake

1. Start to monitor after birds receive vaccine.
2. Select 100 birds per house and check how many have dyed tongues, beaks or crops.
3. Divide the house into four parts and check for staining from 25 birds per house division.
4. Calculate the percentage of birds with staining.
5. Vaccination is considered successful when 95 % of birds show staining after 2 hours.



Illustration of a bird with the correct staining after water vaccination.

Aerosol/coarse spray vaccination

- ✓ Spray vaccination requires careful management. Spray vaccine solutions may be lost through evaporation, settlement and drift before it reaches the birds.
- ✓ Vaccination equipment should be serviced per manufacturer's instructions to ensure correct function and dispersion of the correct particle size.
- ✓ Spray vaccinating day-old chicks in boxes at the farm requires a specific type of sprayer. (Consult vaccine manufacturer).
- ✓ Check that the vaccination equipment is working correctly at least 1 week before vaccination to allow time for repairs if needed.
- ✓ Operators inexperienced with specific house conditions and equipment should practice using plain water to verify walking pace.
- ✓ Use the dedicated sprayer for vaccination only. Never put disinfectant or any chemicals including insecticides into the sprayer.
- ✓ Use fresh, cool distilled water. Ions or chlorine in tap water can inactivate some vaccines.
- ✓ Rinse the sprayer with distilled water and dispense a small volume through the unit before adding the diluted vaccine.
- ✓ A typical coarse spray water volume is 15 to 30 liters (4 to 8 gal) per 30,000 birds. (Refer to vaccine and equipment manufacturer for specific volumes).
- ✓ If using a fine spray the water volume is 1 liter (0.26 gal) per 30,000 birds.
- ✓ Vaccinating in the early morning reduces stress, especially in warm weather.

Aerosol/coarse spray vaccination procedure

1. Turn the fans off before spraying begins. Dim the lights to reduce stress on the birds and give the vaccinator easy movement through the house.
 - ✓ Pen the birds along the inside wall of the house for coarse water spraying. The distance between the vaccinator and the side wall must not be more than 4 m (13 ft).
 - ✓ Coarse spray should be about 1 m (3.3 ft) above bird height.
2. Angle the sprayer nozzle down.
3. Walk through the birds gently and carefully.
4. Leave the fan off for 20 minutes after spraying has finished, provided that the birds are not heat stressed or unattended.
5. After vaccination, rinse the sprayer with distilled water and dispense water through the wand to flush remaining vaccine. Allow vaccination equipment to air dry in a clean, dust free environment. It is very important to take correct care of this valuable equipment to ensure consistent delivery of vaccine for future flocks.

2

House Preparation - Pre-Placement

2.1 Stocking Density

Correct stocking density is essential to the success of a broiler production system by ensuring adequate space for optimal performance. In addition to the performance and profit considerations, correct stocking density also has important welfare implications. To accurately assess stocking density, factors such as climate, housing types, ventilation systems, processing weight and welfare regulations must be considered. Incorrect stocking density can cause scratching, bruising and mortality. Furthermore, litter integrity will be compromised.

Thinning a portion of the flock is one approach to maintaining optimum bird density. In some countries, a higher number of birds are placed in a house and reared to two different target weights. At lower target weights, 20 to 50 % of the birds are removed to satisfy sales in this market segment. The remaining birds then have more space and are reared to a heavier weight.

Many different broiler stocking densities are used around the world. In warmer climates and in houses lacking negative pressure ventilation systems, a lower stocking density is ideal (ex: < 30 kg/m²; (6.2 lb/ft²)). In houses with fully-automated high capacity negative pressure systems, higher stocking densities can be placed. National requirements and Codes of Practice must always be considered when determining final stocking density for broilers.

Stocking Density Guidelines Based on House, Ventilation and Equipment Types			
House Type	Ventilation Type	Equipment	MAXIMUM Stocking Density
Open Sided	Natural	Stir Fans	30 kg/m ² (6.2 lb/ft ²)
Solid Wall	Cross Ventilation	Foggers and Directional Perimeter Inlets	35 to 42 kg/m ² (7.2 to 8.6 lb/ft ²)
Solid Wall	Tunnel Ventilation	Foggers	39 kg/m ² (8.0 lb/ft ²)
Solid Wall	Tunnel Ventilation	Evaporative Cooling	42 kg/m ² (8.6 lb/ft ²)



Animal Welfare Tips

Maximum stocking density must be projected based on the final expected body weight of the broiler flock, and this final weight and density should be achieved the day before or the day of catching.

2.2 Brooding Chamber

The goal is to increase the size of the brooding area as soon as possible, as long as the desired house temperature is achieved. **Prior to expansion, the non-brood area must be heated and ventilated to the target temperature at least 24 hours before releasing birds into the new areas.**

The stocking density in the brooding chamber will depend on the size of the brooding area and the equipment used. Initial stocking should not exceed more than 50 to 60 birds/m² during the winter and 40 to 50 birds/m² during the summer. Ensure adequate drinking space, especially during summer placements. Do not exceed 20 to 25 birds per nipple in a partial brooding house.

Generally, chickens should have access to the entire house after 14 to 16 days old, depending on the final density, house capacity and the house conditions.



Brood Chamber Stocking Density		
Age (days)	Density (birds/m ²)	Density (ft ² /bird)
0 to 3	55 to 60	0.18 to 0.20
4 to 6	40 to 45	0.24 to 0.27
7 to 9	30 to 35	0.31 to 0.36
10 to 12	20 to 25	0.43 to 0.54
13 to 15	Transition to full house	

In poorly insulated buildings, to reduce temperature fluctuations, build a brooding chamber or mini tent inside the house. The mini tent is comprised of a false ceiling that runs from eave to eave. This false ceiling will greatly reduce heat loss and make temperature control easier. A second internal curtain 1 m (3.3 ft) from the outside curtain needs to be installed. The internal curtain must be able to completely seal from the floor to the false ceiling at the eaves. This curtain must open from the top and never from the bottom. The slightest air movement at floor level will cause chilled chicks. The second internal curtain can be slightly open, with a gap just below the ceiling (as shown in the photo on the left) and used for early positive pressure ventilation for the chicks in the brood chamber.



Animal Welfare Tips

Carefully observe chick distribution and behavior as the brooding area is opened and chicks are given more space. Chicks are naturally curious and will want to explore, but will still need to have the correct temperature, lighting and ventilation to ensure they are comfortable, remain active, and easily find feed and water within the expanded area. If supplemental drinker and/or feeder trays are used during brooding, these should be gradually removed from the brooding area over the period of several days before the house is fully open.

2.3 Housing Configuration for Brooding

There are several brooding configurations. A key aspect of the configuration is creating environmental temperatures that are ideal for the birds.

Partial House Brooding Design Option

By using the minimum Cobb standard space requirement for per bird in the brooding chamber, the amount of heat required and energy costs can be reduced. (Check with local guidelines as stocking density requirements may vary based on government regulations.)



Curtain housing - partial house brooding

Whole House Brooding

Whole house brooding is used in solid-side walled houses that are well insulated in regions where labor is limited. The key to successful whole house brooding is the uniform distribution of heat, feed and water throughout the house. Whole house brooding is always the best option in terms of management and early performance.



Closed housing - whole house brooding



Animal Welfare Tips

Migration barriers are useful tools in broiler houses. Barriers can be constructed from different materials (wire fences, large plastic drainage tubes, etc.) and can be installed prior to chick placement and kept in place until broilers are caught at the end of the growout period. Stretching horizontally across the house, migration barriers are beneficial to maintain the desired stocking density in each section, to ensure feed and water provision is appropriate for the birds present in the section, and to prevent large quantities of broilers moving toward the fan or inlet area of the house. Ideally a minimum of 3 or 4 migration fences should be used.

Examples of partial house brooding:

1. Conventional House (or positive pressure)

With a positive pressure system, it is recommended to place the brooding area in the central part of the house (see figure below). For additional insulation during cold weather a double lateral curtain will help. The double curtain in sections 1 and 2 function as a double insulation barrier to retain heat produced in the brooding area.

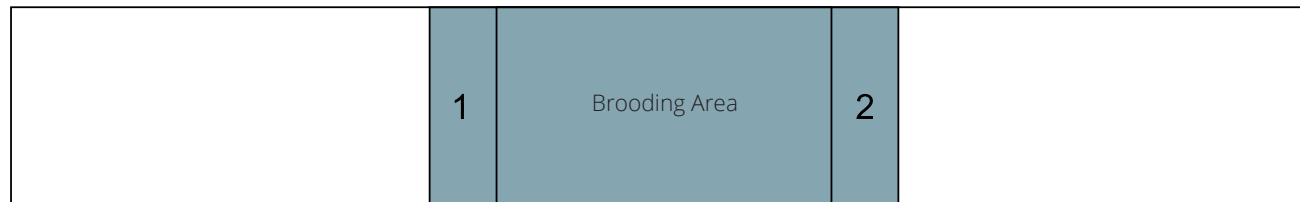

2. Tunnel House – no perimeter inlets (or negative pressure)

If the house is a negative pressure system with no perimeter inlets, the best option is to place the reception area in the center of the house.

During minimum ventilation, the incoming fresh air to the brooding area needs to enter preferably over the top of the brood curtain, to limit air movement at chick level. The goal is to achieve some mixing of the cooler incoming fresh air with the warm air at the ceiling. The opening or gap between the top of the curtain and ceiling is important to try to create an air jet with enough velocity to generate some mixing. However, this will have only limited success if the temperature differential is relatively low. See minimum ventilation section for further details.

The space between the curtains that form the limit of the chamber, should be 1 to 3 m (3 to 9 ft) wide, to facilitate air movement. To help pre-heat the incoming air from the tunnel inlet, an additional heater can be placed in this section. (See the image below for an example of a brood curtain configuration in a tunnel house without perimeter inlets).

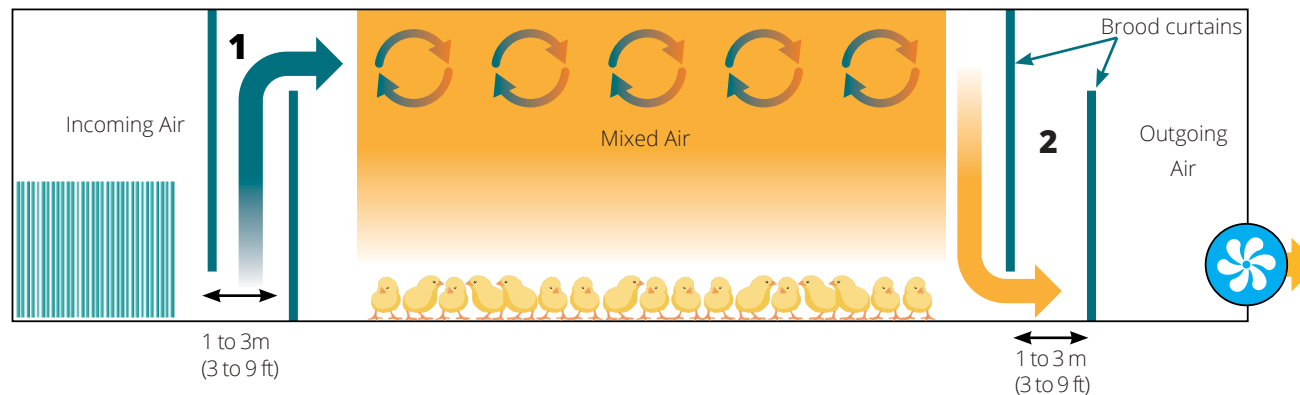

3. Tunnel House

Partial house brooding setups are used worldwide and include a brood chamber in the front, center or end of the house. Floor to ceiling curtains are used to divide a house. A solid 30 cm (12 in) draft exclusion barrier should be placed on the floor in front of the curtains ensuring that no drafts disturb the chicks. The examples here discuss the popular center house option.

The advantages of center house brooding are being able to split flocks evenly between the front and back halves of the house at placement. A migration fence(s) is always placed in the middle of the brood area. The center house configuration makes it easier to release the broilers to the entire house. The migration fences/dividers ensure equal distribution of chicks.

In the diagram below, the red X's indicate those inlets and side wall fans outside the brood chamber which are not being used during the first stages of minimum ventilation. All the inlets in the brood chamber are utilized to achieve the optimum air exchange in the brood chamber during minimum ventilation. The choice of extraction fan position will depend on house design – side wall extraction or end wall extraction. End wall extraction systems pull air in both directions. The main advantage is when the brood curtains are removed and chicks have full access to the house, these fans draw warm air to the cooler/drafty ends of the house. (as shown in the diagrams)

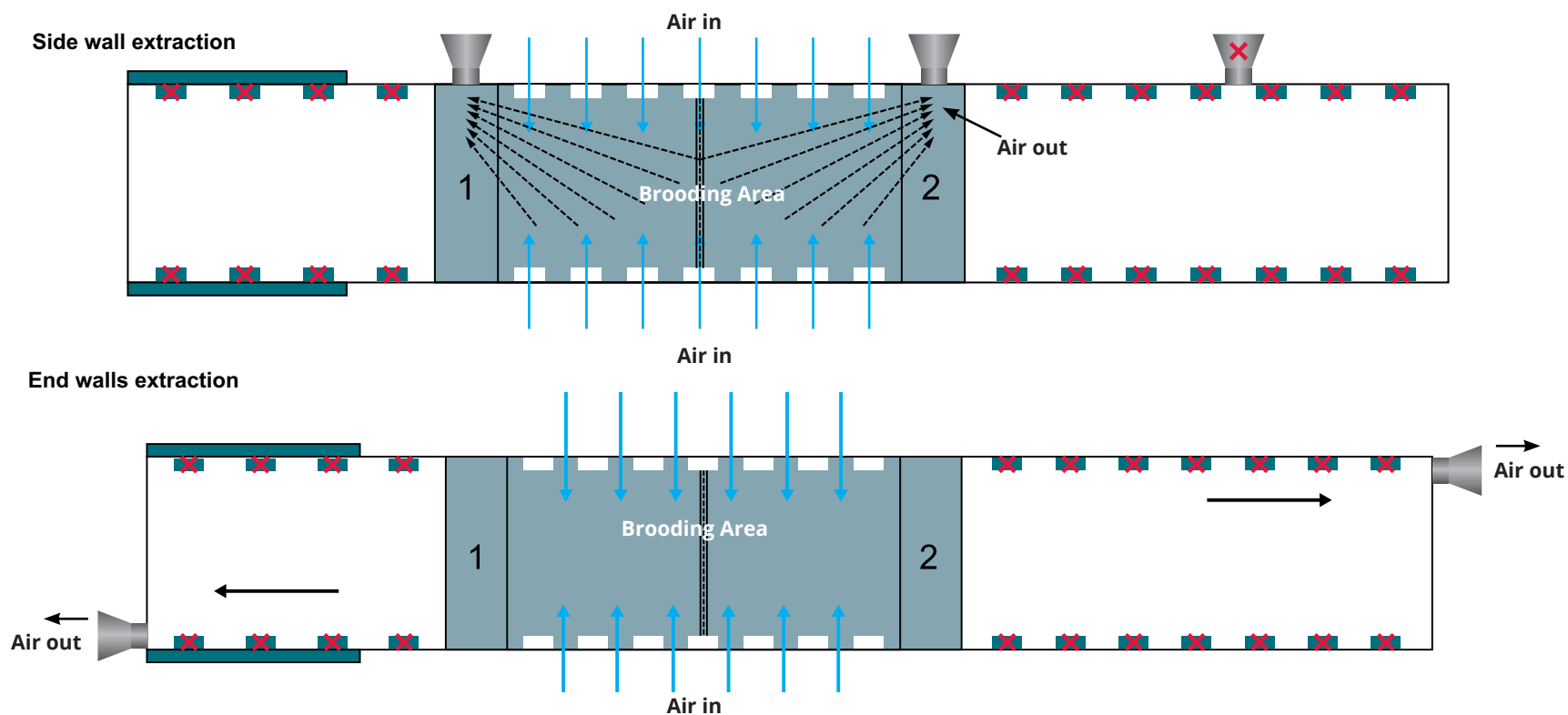

2.4 Drinker Systems

Providing clean, cool water with adequate flow rate is fundamental to good poultry production. Without adequate water intake, feed consumption will decline and bird performance will be compromised.

Bell or Cup Drinkers (Open Systems)

While there is a cost advantage of installing an open drinker system, problems associated with litter quality, condemnations and water hygiene are more prevalent. Water purity with open systems is difficult to maintain as birds will introduce material (litter, feed, etc.) into the reservoirs causing the need for daily cleaning.

Management recommendations

- ✓ Bell and cup drinkers should be suspended to ensure that the level of the drinker lip is equal to the height of the bird's back when standing normally.
- ✓ Height should be adjusted as the birds grow in order to minimize contamination.
- ✓ Water should be 0.5 cm (0.20 in) from the lip of the drinker at day old and gradually decreased to a depth of 1.25 cm (0.50 in) after seven days of age, about the depth of a thumbnail.

Installation recommendations

- ✓ Bell drinkers should provide at least 0.6 cm (0.24 in) per bird of drinking space.
- ✓ All bell drinkers should have a ballast to reduce spillage.



Animal Welfare Tips

Water is important for broilers to achieve the freedom from thirst. Provide clean, cool water that is readily accessible to the flock. Prevent bird stress by having water easily available (correct flow and density) and accessible (correct drinker height). Prevent thermal discomfort by having fresh water available to birds so that they can cool down by drinking or via the effects of the evaporative cooling system. Water will also promote good health and performance.

Nipple Systems (Closed systems)

There are currently 2 nipple configurations on the market, one with and one without drip trays. Drip trays offer the advantage of visual assessment of pressure. Too much water in the drip trays indicates pressure is too high or the nipple line is too low. A moist drip tray indicates the pressure is correct and a dry drip tray indicates that the nipple is not working.

Nipple types have 2 different manufacturing options:

Stamped nipples - less expensive and considerably lower in quality. More leaking issues and often more difficult to activate by day old chicks.

Turned nipples - higher quality than standard nipples due to more precise machining and easier nipple pin activation.

Types of nipple drinkers commonly used

High flow nipple drinkers operate at 80 to 90 ml/min (2.7 to 3 fl oz/min). They provide a bead of water at the end of the nipple and have drip trays to catch any excess water that may leak from the nipple. Generally, 12 birds per nipple with high flow rate systems are recommended.

Low flow rate nipple drinkers operate at a flow rate of 50 to 60 ml/min (1.7 to 2 fl oz/min). They typically do not have drip trays, and pressure is adjusted to maintain water flow to meet the broiler's requirements. Generally, 10 birds per nipple with low flow rate systems are recommended.



Turned nipple with precision machining.

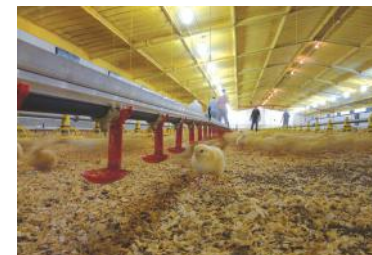

Drip trays can be used to visually assess pressure.

Installation recommendations

- ✓ Nipple systems need to be pressurized either by installing a header tank or pump system.
- ✓ Header tank pressure should be minimum 2 bar (30 psi).
- ✓ Pumped system – 2.8 bar (40 psi) supplied to the control room. Pump systems will need an inline pressure regulator to ensure constant pressure of 2 bar (30 psi) is supplied to the nipple system.
- ✓ Birds should not have to travel more than 3 m (10 ft) to find water.

Nipple Systems (Closed systems; cont.)

Management recommendations

- ✓ Nipple drinkers must be adjusted to suit chick height and water pressure.
- ✓ For systems with stand pipes, pressure adjustments should be made in 5 cm (2 in) increments - as per manufacturer's recommendations. Systems with drip trays should be managed so that birds do not drink from the drip trays. If water is present in drip trays the system pressure is too high.
- ✓ Regularly monitor and test flow rates as more than a visual assessment is required to determine whether all nipples are operational.
- ✓ When floors have a slope, a slope regulator should be installed every 10 cm (4 in) of fall to ensure even pressure down the length of the house.
- ✓ Higher water pressure does not mean higher consumption.
- ✓ Too low water pressure can reduce consumption by as much as 20 %.
- ✓ If the pressure is too low the bird needs more time to obtain its required volume. Regardless, birds will spend the same amount of time drinking whether the volume is high or low (under 1 minute).



How to use the Cobb Water Flow Meter

- ✓ Place under an active drinker line, where birds are drinking.
- ✓ The gauge opening should be placed touching the nipple, preferably at an angle, so that the water flows freely.
- ✓ Take the sample with a stopwatch for 30 seconds and record volume.

The 30 seconds volume required according to age is:

Age (days)	Flow per 30 seconds (ml)
0 to 7	20
8 to 14	25
15 to 21	30
22 to 28	35
29 to 35+	45

Note: The Cobb water flow rate gives an indication of the static flow rate and not the dynamic flow rate, but is a useful comparative management tool.



Animal Welfare Tips

As a general rule, birds should always have to reach up slightly to reach the nipple and should never have to lower their head to trigger the pin of the nipple drinker. Birds should never have to jump to reach water; they should be able to drink comfortably with their feet flat on the floor.

2.5 Feeding Systems

Regardless of the system, feeding space is absolutely critical. If feeder space is insufficient, growth rates will be reduced and uniformity severely compromised. Feed distribution and the proximity of the feeder to the birds are key to achieving target feed consumption rates. All feeder systems should be calibrated for sufficient feed volume with minimal waste.

Chain Feeders

- ✓ Either suspended (winched) or on legs. Winching systems allow easier adjustment.
- ✓ Minimum feed space of 2.5 to 4 cm (1 to 1 1/2 in) per bird.
- ✓ The lip of the track should always be adjusted to be level with the birds back.
- ✓ Chain feeding systems can become a barrier in the house if the height is not adjusted accordingly as birds grow.
- ✓ Feed depth is controlled by feed slides in the hoppers and should be closely monitored to prevent feed wastage.
- ✓ Maintenance of the feed track should be carried out between flocks – corner maintenance and chain tension are very important to prevent breakdowns.
- ✓ When switching to pellets, feed depth should be reduced to 1 cm above the chain.
- ✓ Chain speed is important to ensure uniformity - 18 m/min (60 fpm) is recommended for broilers.
- ✓ If more than one circuit is required, install the extra track running in the reverse direction.

Automatic Feeder Pans

- ✓ The birds per pan range is dependent on final bird size and stocking density. In general, 45 to 65 birds per 33 cm (12 in) diameter pan is recommended.
- ✓ Pan feeders are generally recommended as they allow for unrestricted bird movement throughout the house, have a lower incidence of feed spillage and improved feed conversion.
- ✓ Feeder pans should be primed on each entry to the house to keep the system full or, ideally, operated on an interval timer.
- ✓ If birds are 'tipping' the pans to reach the feed, then the pans are set too high and must be adjusted.

Feed Storage Silos

- ✓ Feed storage silos should have a holding capacity equal to 5 days of feed consumption.
- ✓ To reduce the risk of mold and bacterial growth, it is essential that silos are watertight.
- ✓ It is recommended that two feed silos be installed per house. This allows a rapid change in feed and separate storage for two different feeds. It is always recommended when switching rations such as grower to finisher, or to a non-medicated withdrawal ration, that an empty silo is available
- ✓ Bulk feed silos should be cleaned between flocks.

The number of feed lines recommended based on the width of the broiler house (see illustrations below).

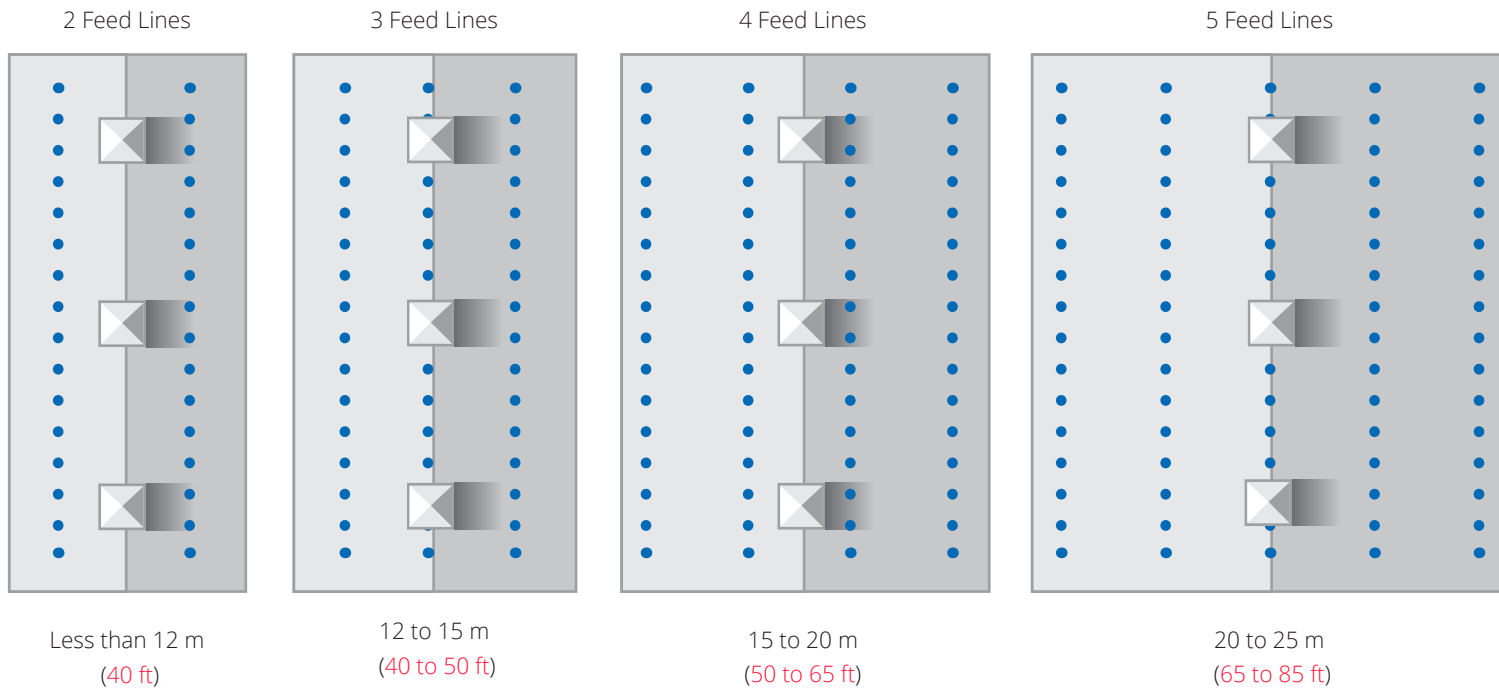

The actual number of feed lines may vary based on stocking density and/or bird feeder spacing.



Animal Welfare Tips

By providing nutritious feed that meets the energy, vitamin and mineral needs of the bird as it grows and develops. Feed also prevents bird stress when easily available (correct density of birds per pan or per feed track) and accessible (correct feeder height). Feed promotes good health and performance. A plentiful ad libitum supply (meaning broilers always have free access to feed) is required to prevent scratches and injuries from accessing feed.

2.6 Heating Systems

The key to maximizing bird performance and welfare outcomes is providing a consistent housing environment according to the needs of the birds. This is especially critical for young birds where a consistent ambient and floor temperature are key factors to promote good activity. The heating capacity requirements will depend on location and the type of system used. The placement of heaters and circulation fan system will depend on house type, heater choice and ventilation system.

Forced air heaters:

These systems encompass a wide range of designs and fuel types. Included would be hot water heat exchange coils mounted with a heat distribution fan. All heating systems require a circulation fan system, especially forced air heat systems, because 100 % of the heat moves to the ceiling, as compared to radiant heating system which directs about 60 % of the heat to the floor. These heaters should be placed at a height of 1.4 to 1.5 m (4.7 to 4.11 ft) from the floor - a height which will not cause drafts on the chicks. The layout of a forced air heating system has many configuration options and will depend on the positioning of minimum ventilation fans, house type, and circulation fan systems. (See section 8.4 for more information on circulation fan systems).

Forced Air Heating System Requirement kW/m ³ (kW/ft ³)	
Tropical Climates	0.05 (1.76)
Temperate Climates	0.075 (2.65)
Cold Climates	0.10 (3.53)

Insufficient heating capacity and distribution will cause uneven temperatures and cold/warm spots resulting in migration, affecting uniformity and performance, and increasing fuel consumption.

Under Floor Heating:

This system operates with hot water circulating through pipes in a concrete floor. The heat exchange within the floor warms the litter and the brooding area.

Radiant / Spot brooders:

Radiant type heating systems, whether traditional round radiant heaters, tube heaters or hot water pipe systems, all create distinctive floor and litter heating patterns within the house. Heating system patterns allow the chicks to find their comfort zone. Water and feed should be close to each other. The number, height and position will depend on the design and heating capacity of the unit. The floor heating patterns and reach vary significantly between the systems. Consult your supplier for more specific details about heating capacity and recommended layouts. Radiant heating can also be configured to include a system of hot water pipes on the side walls and/ or ceiling with in-line perimeter inlets. This system, often found in colder regions, allows incoming air to be heated before distribution through the house.

General Recommendations:

In a controlled environment, ideally, the house should be divided into a minimum of 4 heating zones. Sensor placement position will depend on the type of heating system. Ensure sensors are not close to or being directly affected by the heating system.

Radiant brooders can be used with forced air heaters. Radiant brooders are used as a primary heat source during brooding while forced air heaters provide supplemental heat in cold weather. As the flock ages, birds develop the ability to regulate their internal body temperature. At approximately 14 days of age, forced air heaters can become the primary heat source.

A radiant type heating system is always the best option for poorly insulated houses. A forced air heating system in combination with a circulation fan system are more suitable for well insulated solid side wall houses.



Animal Welfare Tips

Chick behavior, distribution and activity are key factors to observe when assessing chick comfort. If the floor temperature is too cool, chicks will have cold feet, will be less active, and will likely huddle and sit still to conserve their body temperature. If the floor and ambient temperatures are optimal, chicks should be active, their feet should feel warm, and chicks should be well-distributed in the brooding area as they eat, drink, explore and rest. If floor temperature is too hot chicks will spread out to maximize surface area and pant to eliminate excess heat.

2.7 Litter Management

Litter management is an important part of environmental management and good animal welfare. Correct litter management is also fundamental to bird health, performance and final carcass quality which subsequently impacts the profit of both farmers and poultry production companies.

Though several alternatives may be available for litter material, certain criteria should apply. Litter should be absorbent, lightweight, non-toxic, free from contaminants, ideally inexpensive to purchase, and sustainably sourced.

Important functions of litter include the ability

- ✓ To absorb moisture.
- ✓ To dilute excreta, thus minimizing bird contact.
- ✓ To provide an insulation layer between the chicks and the cold floor.
- ✓ To allow broilers to express normal behavior (such as foraging and pecking) as they grow and develop.

Litter Options and Characteristics



Sawdust (kiln dried)
Excellent absorptive qualities.



Chopped Straw

Wheat straw is preferred to barley straw for absorptive qualities. Coarse chopped straw tends to cake due to low absorptive qualities during the first few weeks. Straw should be chopped to lengths of 2 cm (3/4 in) or less.



Hardwood Shavings

May contain tannins which cause toxicity concerns and splinters that may cause crop damage.



Paper

Difficult to manage when wet; may have a slight tendency to cake and glossy paper does not work well.



Sawdust

Often high in moisture, prone to mold growth and the presence of aspergillosis.



Rice Hulls

An inexpensive option in some areas, rice hulls are a good litter alternative.



Peanut Hulls

Tend to cake and crust but are manageable.

Sunflower Husks, Straw Pellets or Sand are other options.



Animal Welfare Tips

If litter becomes wet beneath drinkers, water pressure and drinker height should be evaluated. After the cause has been identified and addressed, remove any caked litter and replace with fresh or dry litter. This will encourage birds to use this area of the house.

Litter Evaluation

A practical way to evaluate litter moisture is to do a simple litter squeeze test in several locations. Litter moisture should be evaluated in several location around house, but not immediately under or around drinking or feeding systems. Litter should be loosely compacted when squeezed in the hand. If the litter remains in a clump when it is squeezed in the hand, it is too wet. For optimal broiler welfare and health, litter should cover the entire floor and should be dry and friable (loose). High litter moisture (caked or clumped) may cause breast blisters, foot pad lesions, high ammonia levels, and other welfare and health concerns if not corrected.

Minimum Litter Depth (or Volume) Requirements

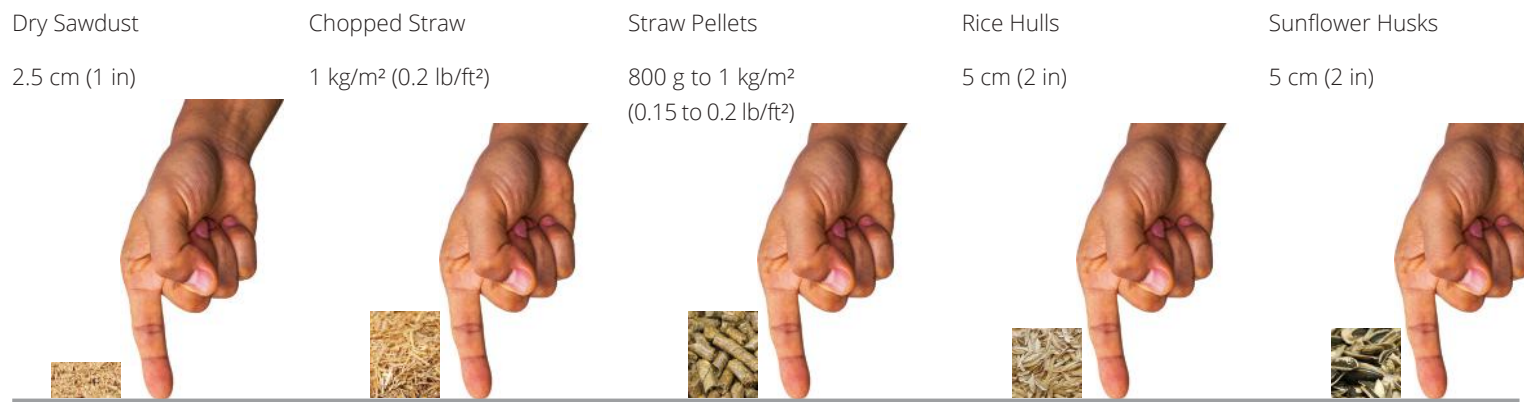

Note: The above are recommendations for litter depth measurement for housing with concrete floors. For housing with earth floors, a minimum depth of 10 cm (4 in) is advised, in order to provide insulation from the ground and adequate moisture holding capacity.



Animal Welfare Tips

Ideally, litter moisture should be < 35 % throughout the broiler house. Litter that has < 35 % moisture will be friable or loosely compact when squeezed in your hand. If litter is damp, caked or increasingly moist, verify the settings and function of the drinker and ventilation system. If litter quality is not improved, welfare concerns related to hock and footpad condition and air quality within the house may result.

Litter Alternatives

Plastic slats offer an alternative flooring system where cost and availability of good quality, hygienic litter materials are sparse or cost-prohibitive. However, plastic slats can present moisture and fly control issues due to poor air movement below the slats. Holes in the slats must be wide enough for manure to fall through, but small enough to prevent feet and legs injuries to the broilers. In many countries, if managed correctly, plastic slats can be a viable option to provide good welfare and performance.



Re-using Litter

Re-use of litter is practiced in a number of countries with a degree of success. Some key points to consider when reusing litter include:

- ✓ All wet caked litter must be removed during down time between broiler flocks.
- ✓ In the case of a disease challenge, it is never recommended to re-use the litter.
- ✓ When re-using litter, maintaining good litter quality is essential to achieving optimal performance. The litter should be replaced as necessary, preferable after 4 cycles and at least annually.
- ✓ Down time between flocks should be at least 14 days to maintain good litter quality and control bacterial and fungal proliferation .

The practice of “in-house” litter composting to encourage the production of heat is common for the control of litter flora and pathogens. While effective in the litter, the method does not necessarily address any pathogens present in the pad below the litter. Acidifying the pad at the same time as composting can help reduce any pathogen load.

Re-using Litter (cont.)

While the process of litter fermentation is very beneficial, it does not address the large amounts of ammonia that will be released after the litter is spread out and heated before placement. High levels of ammonia arise as litter material is broken to increase surface exposure and can exceed 200 ppm. Litter amendments would be overwhelmed at these levels. Therefore, it is always recommended to apply litter amendments after spreading the processed litter, just prior to chick placement to keep ammonia levels below 25 ppm. It is also recommended run the ventilation system during and after fermentation to help remove the high levels of ammonia from the house.

The most common litter amendment is sodium bisulfate – a granular hygroscopic acid which can pull water or moisture from the air and litter to become active and offers the benefit of reducing pH without introducing water.

When the pH of the litter is lowered below 7, the ammonia is converted to ammonium, which can form a salt that remains in the litter as opposed to being released into the air. By lowering pH the beneficial bacteria such as the lactobacilli remain active, whereas some harmful bacteria are sensitive to low pH levels.

Using specific protocols during downtime (ex: using litter amendment products to reduce ammonia; heating the house to minimize pathogen presence; using products to disrupt insect life cycle; adding new shavings on top of reused litter in brooding area) can be beneficial for the health, welfare and performance of the subsequent broiler flock.

2.8 Pre-Placement Checklist

The key to successful broiler rearing starts with having a systematic and efficient preparation program in place. This program must start well before the chicks arrive on the farm. Pre-placement house preparation provides a solid foundation for efficient and profitable broiler production. The following checks are required:

1. Heater Checks

Verify that all heaters are installed at the recommended height and are operating at maximum output. Heaters should be checked and serviced BEFORE pre-heating begins.

2. Temperature Sensor Checks

- ✓ Place temperature sensors at bird height and away from any heat source and in cooler sections of the house, such as close to side walls.
- ✓ Minimum/maximum thermometers can be placed alongside a single electronic house temperature sensor as a reference. Modern temperature sensors are usually very reliable and rarely require calibration.
- ✓ Temperature ranges from the minimum/maximum thermometers and controller sensors should be recorded daily and not deviate by more than 2 °C (4 °F) from the target over a 24 hour period.
- ✓ Temperature sensors can be calibrated using an accurate mercury thermometer and a container of water - the water will provide a stable medium for the calibration.

3. Floor temperature check

- ✓ Houses should be preheated so that the floor, litter, and ambient temperatures are stabilized at least 24 hours before placement.
- ✓ 24 hours prior to placement, litter temperatures should be 30 to 32 °C (86 to 90 °F) with forced air heating. If radiant heaters / brooder stoves are used, litter temperatures should be 40.5 °C (105 °F) under the heat source. Litter temperatures should be 30 to 32 °C (86 to 90 °F) throughout the rest of the house. To achieve the above targets, pre-heating needs to commence at least 48 hours before chick placement.
- ✓ Concrete temperature (below litter) should be 28 to 30 °C (82.4 to 86 °F).
- ✓ The minimum ventilation and circulation fan systems need to be running during this preheating period.
- ✓ Pre-heating time is dependent on local climate conditions, house insulation and heating capacity and can vary from farm to farm.
- ✓ Often concrete/litter temperature is measured quickly at chick placement in a few random areas, which is not representative of the true uniformity of concrete/litter temperatures. The best way to measure is to take a reading (concrete and litter) every six meters over the length of the poultry house and in three rows across the width of the house (see image top right).
- ✓ Litter temperature should be recorded before each placement. This will help evaluate the effectiveness of pre-heating and circulation fan systems.

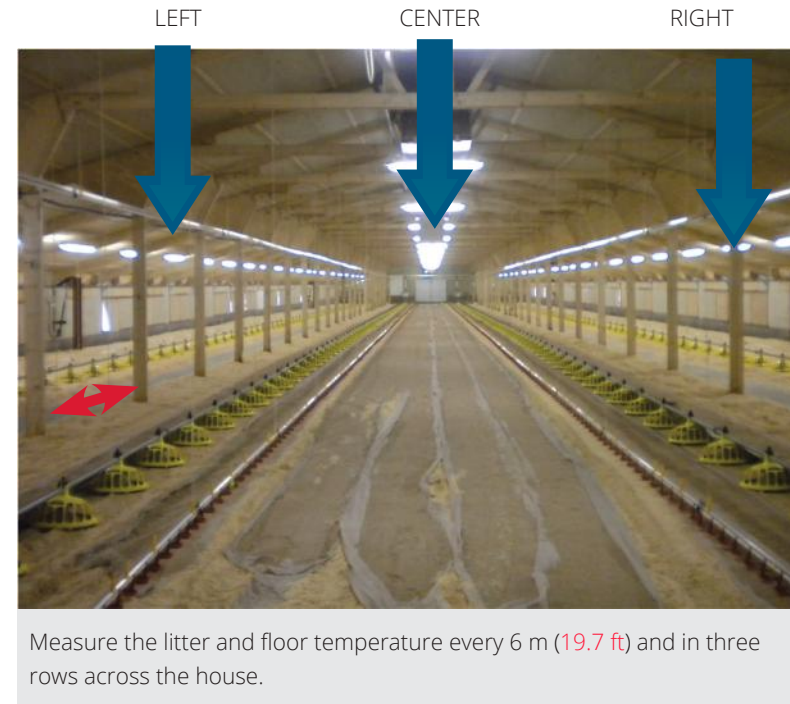

Animal Welfare Tips

The chick is highly dependent upon the manager to provide the correct litter temperature. If the litter and air temperatures are too cold, internal body temperature will decrease, leading to increased huddling, decreased activity, reduced feed and water intake, stunted growth and susceptibility to disease. Overheated chicks will spread out wings and pant to eliminate heat. Growth will slow because of dehydration and reduced feeding activity.

Floor temperature check (cont.)

Floor temperatures are critical for the first two weeks as the birds tend to lose significant heat through their feet. Correct concrete temperature has a big impact on early performance especially mortality, weight gain and flock uniformity. The illustrations are two examples of concrete temperature profiles with two different heater placements. Temperatures were taken prior to chick placement. Measuring the concrete temperature can determine if the heater placement and circulation fan systems are working together to ensure uniform floor temperatures. Heater placement positions and circulation fan systems need to work together to ensure uniform floor temperatures.

19 to 20.9 °C
66.2 to 69.7 °F

21 to 22.9 °C
69.8 to 73.3 °F

23 to 24.9 °C
73.4 to 77.0 °F

25 to 26.9 °C
77.1 to 80.6 °F

27 to 28 °C
80.7 to 82.4 °F

Excellent temperature uniformity of concrete floor

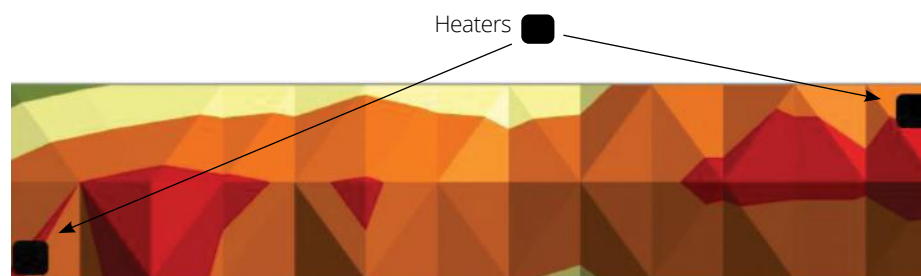

Poor temperature uniformity of concrete floor

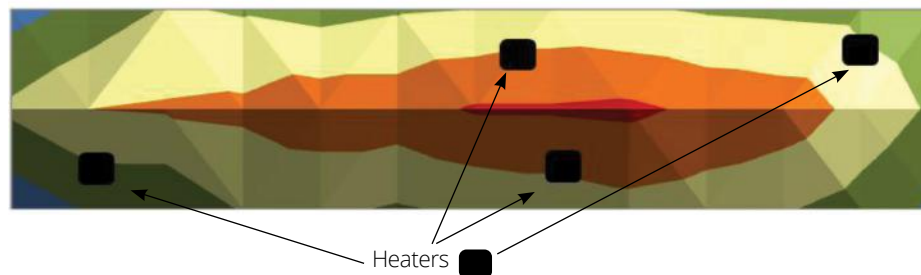

4. Minimum Ventilation Check

- ✓ Minimum ventilation should be activated as soon as the preheating begins, in order to remove waste gases and any excess moisture.
- ✓ Seal air leaks to eliminate drafts on chicks.
- ✓ Check carbon dioxide level before placing chicks. CO₂ levels should always be < 3,000 ppm.
- ✓ If chemicals are used during the cleaning and disinfection phase prior to preparing the house for chick placement, adequate ventilation must be used to clear the house of the residue and to provide clean air for the chicks.
- ✓ If litter is reused, the ammonia level should be < 25 ppm before chicks are placed.

5. Drinker Check

- ✓ Ensure adequate drinking space, especially during summer placements. Do not exceed 20 to 25 birds per nipple in partial house brooding.
- ✓ Flush all drinkers to remove any residual sanitizer.
- ✓ Water must be clean and fresh.
- ✓ If supplemental drinkers are used, they should be placed so that the chicks will make the association between supplemental drinkers and the primary source.
- ✓ Manually activate all nipples prior to placement.
- ✓ Adjust pressure to produce a droplet of water visible on each nipple, without dripping.
- ✓ Check for water leaks and air locks.
- ✓ Ensure that nipple drinkers are at the chicks' eye level.



6. Feeder Check

Paper Feeding

- ✓ The automatic feeding system should be placed on the concrete floor or down in the litter to make access to the feeding system as easy as possible for the chicks.
- ✓ The feeding system should be set on overflow/flood mode for chick placement (if possible).
- ✓ For full house brooding, 75 to 100 g of feed per chick (16.5 to 22 lb/100) should be placed on supplementary paper. A line of paper should be placed at each side of each drinker line. The paper quality should be high enough that there is adequate time (5 days) for feeding before the paper breaks down (47 to 55 g/m² and 55 to 68% brightness).
- ✓ For partial house brooding, supplementary feed should be provided for the first 7 to 10 days in the form of turbo feeders / trays and paper. Trays should be less than 6 mm (1/4 in) deep and 75 % of the floor area covered with paper. Allow a minimum of 75 chicks per supplementary feeders.

General Rules

- ✓ It is very important that the supplementary feeding system does not run empty as this will place great stress on the chick and reduce yolk sac absorption.
- ✓ The base of the supplementary feeders should never be exposed - keep full at all times!
- ✓ Supplemental feeders should be refreshed three times daily until all the chicks are able to gain access to the main feeding system.
- ✓ Starter feed should be provided as a good quality crumble.
- ✓ Do not place feed or water directly under the heat source as this may reduce feed and water intake.
- ✓ The automatic feeder system should be flooded at all times to ensure easy chick access to feed.

Turbo Feeder



Supplementary Paper



Chick Placement

3.1 Key Placement Requirements









- ✓ Place chicks from similar flock sources in a single house (a maximum of 5 weeks difference in age is recommended if one flock is composed from different sources).
- ✓ Placement per farm should ensure an 'all in-all out' system.
- ✓ Transportation must provide ideal conditions for the chicks and the delivery time should be as short as possible. (Refer to the Cobb Hatchery Guide)
- ✓ Delays in placement can contribute to the dehydration of chicks, resulting in higher chick mortality and reduced growth rate.
- ✓ Weigh 5 % of the boxes to determine day old chick weight. To calculate uniformity and CV, weigh individual chicks (not boxes of chicks).
- ✓ Reduce the light intensity during chick placement to minimize stress and to keep chicks calm until placement is complete in the house.
- ✓ Chicks must be carefully placed and evenly distributed near feed and water throughout the brooding area. When using supplemental paper feeding, place chicks on the paper.
- ✓ Lights should be brought to full intensity (minimum 25 lux; 2.5 fc) within the brooding area once all chicks have been placed.
- ✓ Monitor the distribution of the chicks closely during the first few days. This can be used as an indicator for any problems in feeder, drinker, ventilation or heating systems.

3.2 Chick Quality

Characteristics of a good quality chick

- ✓ Dry, long-fluffed down.
- ✓ Bright, round, active eyes.
- ✓ Active and alert.
- ✓ Have completely healed, closed, and dry navels.
- ✓ Legs should be bright and waxy to the touch.
- ✓ Legs free of red hocks and injuries.
- ✓ Chicks should be free from deformities (i.e. deformed legs, twisted necks and cross beaks).
- ✓ Day old chick uniformity (CV of 7.9; Uniformity 80 %).

Chick Grading and Characteristics

	A	B	C
Navels			
Legs			
Hocks			
Characteristic	A Excellent	B Acceptable	C Cull
1. Reflex	Chick can flip over within 3 seconds	Chick flips back over between 4-10 seconds	Over 10 seconds or fails to flip over
2. Navel	Clean and well healed	Closed but slight abrasiveness	Not closed/string/button attached or discolored
3. Legs	Clean, waxy legs	Some dryness/pale	Dehydrated with vein protruding
4. Hocks	Clean, no blemishes	Slight blushing	Red color/heavy blushing
5. Defects	Clean, no defects	Minor defects (ex: yolk staining, feather coloration, etc.)	Missing eye/blind, legs with cuts/abrasions, spraddled legs, cross beaks, poor feathering, clubbed down



Animal Welfare Tips

A reflex reaction is a simple quality test that can be conducted on individual chicks in the hatchery to assess chick health and welfare status. For this test, while securely supporting the body of the chick in your hand, gently place the chick on its back in an empty chick box. A chick with normal behavior, good health and excellent quality traits should easily flip over and then stand within 3 seconds. If a chick does not right itself within 10 seconds, or fails to turn over and stand within this time period, the chick should be evaluated for culling since it may have a biological or physiological deformity that will prevent it from living a normal, healthy life.



Chick Placement

Before unloading chicks at the farm, the floor and ambient temperature should be verified. If the house is too cool, chicks should remain within the climate-controlled chick truck to prevent thermal stress. Careful and strategic placement of chicks in the brood area is important for animal welfare.

Pay attention to these items when placing chicks to optimize chick comfort, security, and quality:

Handling (action)

All staff should take care when handling chick boxes during unloading from the truck, when transporting them within the house, and during the placement process. The goal should be to prevent rough movement (ex: tilting chick boxes, dropping chick boxes, etc.) as this can potentially injure chicks. Ideally, boxes should always remain level until each individual box is tipped for chick placement.

Handling (method)

Farm staff must gently place the chicks in accordance with company drop height limits. The drop height should be no greater than 2 times the bird height (about 15 cm (6 in) for chicks). This means that the person must hold the box securely with both hands and tipping (below knee level) should minimize the drop distance from the bottom of the box to the litter.

Handling (location)

The location where chicks are placed is critically important. Chicks should be gently placed directly on litter, starter feed lids, or the paper that has starter feed. Do not place chicks on top of solid equipment (ex: feeders or drinkers) or on top of other chicks. When placing chicks on the litter, chicks should have easy access to water and feed, and should be near but not directly underneath a brooder.

Handling (strategy)

Ideally, chick unloading should be quick and efficient to minimize exposure to external climates that may result in thermal stress for the chicks. Ideally, all boxes should be placed in the house or brood area so that chicks will be evenly distributed from the first moment of placement. Once boxes are distributed, begin at the back of the house or brood area and place chicks in a careful and calm manner as you move towards the front of the house. This will help prevent chick injury and chicks being around the feet of the staff during the reception process. Try to talk as little as possible. Chicks are looking for the mother hen and they should not associate voices as being the mother hen. Remove all paper liners, chick boxes, lids, etc. during the process to prevent areas of potential entrapment for the chicks, and dispose of these items in a biosecure manner. After placement all staff should leave the house for 2 hours to let the chicks become acclimated to the reception area.



3.3 Brooding Management

The importance of the brooding period cannot be over emphasized. The first 14 days of a chick's life sets the precedent for good performance. Extra effort during the brooding phase will be rewarded in the final flock performance.

While placing chicks and checking on chicks during the brooding phase, staff should talk at a low level and move calmly through the house to minimize stress. After ensuring that all chicks are placed and comfortable, staff should leave chicks alone for a minimum of 2 hours to allow them to acclimate to their new surroundings and to rest.

Check chicks 2 hours after placement which will give them time to settle and identify the reception area. Ensure they are comfortable. Chick distribution and behavior should be closely monitored after placement for the first 24 to 48 hours of brooding. It is normal to see some chicks sleeping, some chicks eating or drinking, and some chicks actively exploring their new environment. If you observe chicks panting, huddling, chirping loudly or irregularly distributed within the brood area, investigate the cause(s) immediately. If not corrected, brooding management errors can have a negative impact on flock welfare and performance outcomes.

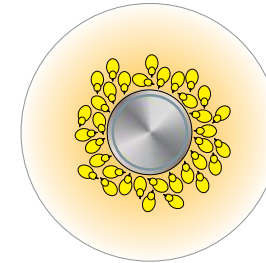
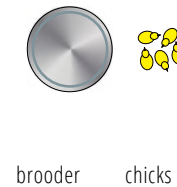

Too cold
Noisy chicks huddled under the brooder

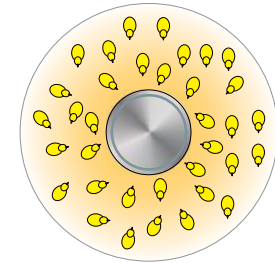

Just right
Chicks are constantly cheeping and spread evenly

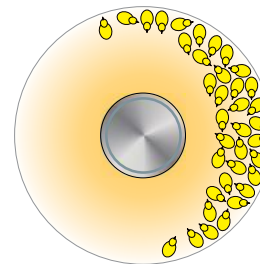

Bright light or noise
Chicks huddled to one side of the brooding area

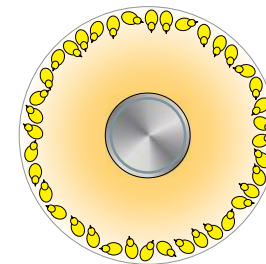

Too hot
Drowsy chicks spread around the perimeter away from the brooder

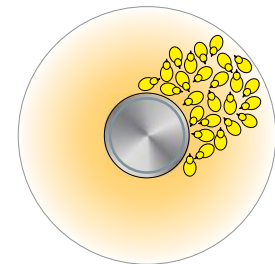

Too drafty
Noisy chicks huddled together away from draft



Animal Welfare Tips

Every time you enter a poultry house, you should see some birds eating, playing, drinking, chirping, and resting. Birds should never be huddling. Chick distribution and behavior should be closely monitored after placement and within the first 24 to 48 hours of brooding. It is normal to see some chicks sleeping, some chicks eating or drinking, and some chicks actively exploring their new environment. Chicks will normally stay close to the heat, feed and water sources during the first 2 to 3 days on the farm. Look for chicks that are loudly chirping, non-responsive to sound and movement, or exhibit irregular posture or movement. Any chicks that cannot stand, walk, eat or drink normally, and those that are failing to thrive should be evaluated for culling.

Chick Temperatures

- ✓ Chick internal temperature can be measured using a digital thermometer with a soft tip. It is best to use quick-reading, digital thermometers for this check.
- ✓ Optimal chick internal temperature should be 40 to 40.6 °C (104 to 105 °F).
- ✓ Chick internal temperature above 41 °C (106 °F) in first 4 days will lead to panting.
- ✓ Chick internal temperature below 40 °C (104 °F) indicates that the chick is too cold.
- ✓ Chick internal temperature increases over the first five days from 41 to 42 °C (106 to 108 °F).
- ✓ An excellent indicator of floor temperature is the temperature of the chick's feet. By placing the chick's feet against your neck or cheek, you can assess if the chick is warm or cold. If the chick's feet are cold, the internal body temperature of the chick is also reduced.
- ✓ Cold chicks will huddle and become inactive, resulting in reduced feed and water intake and growth rate.
- ✓ If they are comfortably warm, the chicks should be evenly and actively moving around the brooding area.



Floor temperatures are critical for the first 2 weeks as the birds tend to lose heat through their feet.

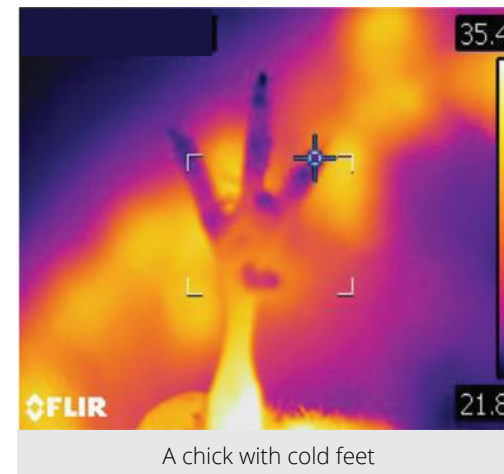
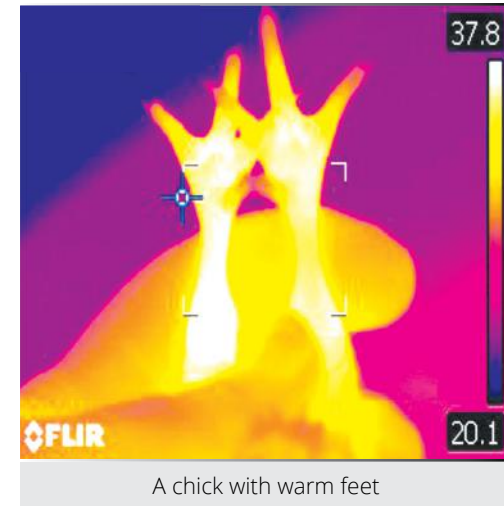

4

Post Placement

4.1 Post Placement Management

Ensure that both feeders and drinkers are adequate, according to the stocking density, and close to each other. It's important that areas with feed and water have the correct ambient, floor and litter temperature, protecting the chicks' "thermal comfort zone."

Mini Drinker Check (Supplemental)

Many modern poultry houses are well-equipped with drinker systems that can be used by chicks at placement. When possible, use only the primary drinker systems so chicks will learn to use the system as quickly as possible. If supplemental drinkers are necessary, open trays are not recommended since chicks may immerse themselves in these and / or contaminate the water with litter and feed reducing water quality. Supplemental drinkers should never be placed directly beneath the brooders as this will heat the water, causing increase water evaporation and microbial growth.

- ✓ Provide 6 to 8 supplemental drinkers per 1,000 chicks.
- ✓ Never allow the drinkers to run dry.
- ✓ Clean and refill the drinkers as necessary.
- ✓ Maintain maximum water levels until drinkers are removed (approximately 48 hours after placement).
- ✓ Drinkers should be placed slightly higher than the litter to maintain water quality yet not so high that access is impeded (ex: on top of a box lid or carton egg flat).
- ✓ Water spillage and waste should be kept to a minimum especially during cold seasons because of lower air exchange during these months.



Animal Welfare Tips

Evaluate chick behavior, appearance and activity in the hatchery and at placement. Ideal chicks should look bright, alert, and active with good color and good quality attributes.

Nipple Drinker Check

- ✓ Height should be at chick's eye level for the first 2 to 3 hours and then maintained slightly above chick's head.
- ✓ Place drinker lines at a height that the birds have to stretch slightly to reach.
- ✓ At placement a bead of water should be visible on the end of the nipple to encourage water consumption - this is achieved by setting the pressure low in the drinking system. After the first hours and once water consumption has been adequately achieved, increase the drinking system pressure and check the height of the nipple line to prevent spillage and wet litter.
- ✓ The bird's feet should always be flat on the litter and a bird should never have to stand on its toes to drink.
- ✓ As a general guide, a nipple flow rate of 40 ml/min is recommended in the first week. However, always refer to the manufacturer's instructions.
- ✓ Water in the drip trays is easily contaminated from the environment and wasted onto the litter, therefore chicks should not drink from the drip trays after the first day of placement.

Flushing Water Lines

All poultry watering systems should be flushed daily, but at a minimum of three times per week to remove biofilm and control water temperature. If water systems are not flushed regularly, biofilms can form on the inside of the pipe decreasing water flow and quality.

During the first week, water flow rates are low which could allow bacterial growth. Flush the water system at least two or three times daily to maintain a good water temperature and quality.

High pressure flushing requires having adequate volume and pressure. One to two bars (14 to 28 psi) of water pressure will create the velocity and turbulence in the pipe work to remove biofilm. In warm or hot climates, it might be necessary to flush more than once a day to cool the water temperature. There are automatic flushing systems that make the flushing job easier, saving the producer time and ensuring the water flushing happens. For systems with flush modes, set to flush at 2 seconds per meter (3.3 ft) of drinker line.

Bell Drinker Check

- ✓ Height should be maintained such that the lip of the drinker is at the level of the chick's back.
- ✓ Frequent assessment and adjustment are essential.
- ✓ Must be cleaned daily to prevent buildup of contaminants. If necessary, in hot climates, flush the water system at least two or three times daily to maintain a good water temperature.
- ✓ Bell drinker water level should be 0.5 cm (0.20 in) from the lip of the drinker at day of age and reduced gradually after seven days to a depth of 1.25 cm (0.5 in) or thumbnail depth.

Drinker height recommendations

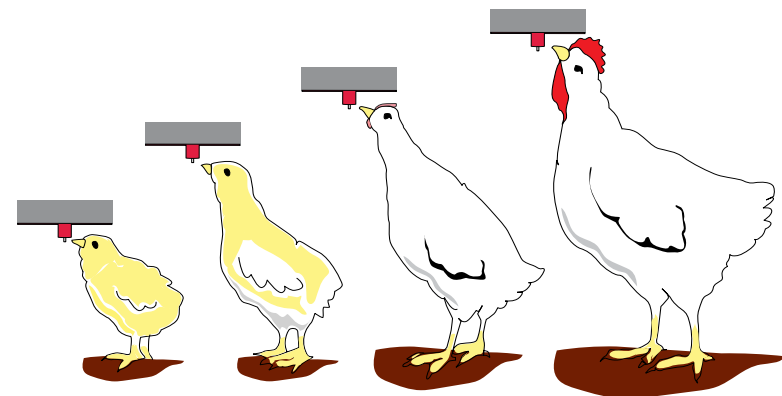

At placement, nipple pin should be at chick eye level.

After 2 to 3 hours and beyond, adjust height so that the bird's head is at a 45-degree angle to the nipple.

Feeder Check

- ✓ Feed should be provided in a crumble form and placed on trays or paper.
- ✓ Automatic feed pans should be placed in full flood mode to maximize accessibility.
- ✓ For brooding, automatic feed pans should be placed on the ground, down in the litter and set on overflow (flooding of pans) where possible.
- ✓ The feed level within the automatic feed pans should be set so that feed is readily available while spillage is minimized.
- ✓ Automatic feeders need to be raised incrementally throughout the growing period so that the lip of the trough or pan is level with the bird's back at all times.

Crop Fill Evaluation

The main objective of management during the first hours after placement on the farm is to achieve as much intake of water and feed in as many chicks as possible. Failure to achieve this objective will lead to irreversible problems with flock performance including poor growth, poor feed conversion and poor flock uniformity.

The yolk contains 2/3 fat and 1/3 protein - fat for energy and protein for growth. If early feed consumption doesn't occur, the chick will use fat and protein in the yolk for energy, leaving inadequate protein for growth. Early feed intake is crucial for chicks to sustain metabolic processes such as internal body temperature.

Sample 100 chicks per brooding area. If the crops of the chicks are checked 8 hours after placement a minimum of 85 % of examined chicks should have both feed and water present. A minimum of 95 % of the bird's crops should be filled during examination 24 hours after placement.

- ✓ If too many crops are hard (> 15 %), immediately evaluate water availability, water temperature, flow rate, etc. to determine why chicks may not be accessing water in the brood area.
- ✓ If too many crops are soft (> 15 %), immediately evaluate feed availability, feed location, feed presentation (uniformity and smell), and verify that the correct feed was delivered to the farm. Check ambient and floor temperatures. Low temperatures will result in poor activity and limited access to feed and water.



Animal Welfare Tips

If too many crops are hard, immediately evaluate water availability, water temperature, flow rate, etc. to determine why chicks may not be accessing water in the brood area.

If too many crops are soft, immediately evaluate feed availability, feed location, presentation (uniformity and smell) of the feed ration, and verify that the correct feed was delivered to the farm to determine why chicks may not be accessing feed in the brood area.

Growing Phase

5

Broiler producers must place added emphasis on supplying a feed that will produce a product to meet their customers' specifications. Growth management programs optimizing flock uniformity, feed conversion, average daily gain and livability are most likely to produce a broiler that meets these specifications and maximizes profitability.

5.1 Uniformity

Uniformity is a measure of the variability of bird size in a flock. This can be measured by:

- ✓ weight +/- 10 %
- ✓ coefficient of variation
- ✓ carcass yield evaluations post processing

Calculating flock uniformity

1. Divide the house into three sections.
2. Take a random sample of approximately 100 birds from each section or 1 % of the total population.
3. Weigh and record the individual weights, and then calculate the average body weight.
4. It is important to weigh all birds within the catch pen, excluding culls.
5. Count the number of birds that are 10 % on either side of the average body weight of the 100 bird sample.
6. This number expressed as a percentage of the 300 birds sampled is the flock uniformity percentage.

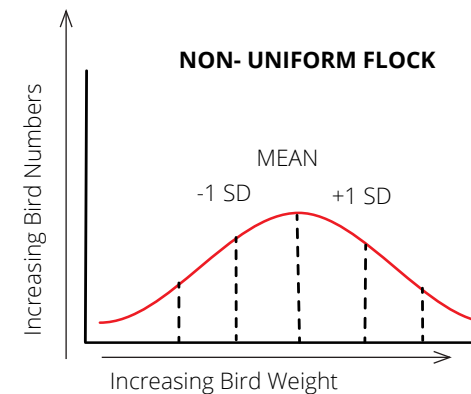
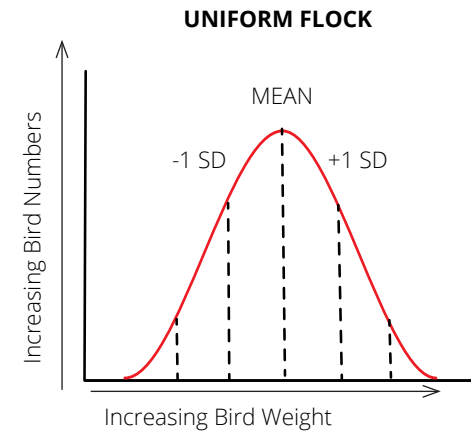

Examples of uniformity curves. In the top curve, the weights are very similar among the birds in the uniform flock. In the bottom curve, uniformity is poor, and the weights of the birds are widely variable among the population.

Coefficient of Variation (CV)

The coefficient of variation (CV) is commonly used to describe variability within a population. A low CV indicates a uniform flock. A high CV indicates a non-uniform flock. An acceptable broiler flock uniformity, at hatch, has a CV of 8 to 10 (day old chicks have an average uniformity of 80 % or CV of 7.9).

Variation can be expressed either in terms of:

- ✓ Percent uniformity
- ✓ Standard deviation of body weight
- ✓ Coefficient of variation in body weight

The coefficient of variation is a comparative measure of variation that allows the change in variation during the growth of the flock to be monitored. The standard deviation is a measure of how widely values are dispersed around the average value (the mean). In a flock with a normal distribution, approximately 95 % of the individual birds will fall in a band +/- two standard deviations of the average body weight.

% Uniformity	Coefficient of variation CV (%)	Uniformity Evaluation
95	5	Uniform
90	6	
85	7	
79	8	Average
73	9	
68	10	
64	11	Poor
58	12	
56	13	
52	14	
50	15	
47	16	

Seven-day Body Weight and Flock Performance Checks

- ✓ Seven-day mortality is a good indicator of chick quality, hatching process, house set up and early brooding management.
- ✓ Cumulative 7 day mortality should not exceed 1%.
- ✓ Measuring seven-day weights will give an indication of how successful the brooding management has been.
- ✓ Every extra gram gained by day 7 can result in a cumulative increase of 6 to 7 g at 35 days.

- ✓ By 7 days of age, chicks should have a minimum weight gain of 4.8 times their day-old weight.
- ✓ Minimum water consumption of 1 ml/bird (3.4 oz/100 chicks) per hour for the first twenty four hours after placement.
- ✓ Failure to achieve good seven-day weights will mean an inferior result at the end of the growing cycle.

5.2 Temperature and Stocking Density Management

A comfortable chick will breathe through its nostrils and lose 1 to 2 g of body weight (in the form of moisture) in the first 24 hours. The yolk also contains 1 to 2 g of moisture so the chick will lose weight but not become dehydrated. If chicks start panting, they can lose 5 to 10 g of moisture in the first 24 hours and dehydration can occur. Higher relative humidity can reduce moisture loss but can impair thermal regulation, thus providing the correct temperature for the relative humidity condition of the house is vital. (See table right)

Temperature Recommendation Based on House Relative Humidity Guidelines

Age (days)	30 %		40 %		50 %		60 %		70 %	
	°C	°F	°C	°F	°C	°F	°C	°F	°C	°F
0	34	93.2	33	91.4	32	89.6	31	87.8	30	86.0
7	32	89.6	31	87.8	30	86.0	29	84.2	28	82.4
14	29	84.2	28	82.4	27	80.6	26	78.8	25	77.0
28kg/m ² (5.73 lb/ft ²)	25	77.0	24	75.2	23	73.4	22	71.6	21	69.8

Chicks from young pre-peak breeder flocks are smaller with higher surface area to body mass ratios and therefore lose more body heat than larger chicks. For smaller chicks, increase the air temperature by 1 °C (2.5 °F) for the first week.

Any time stocking densities increase above 28 kg/m² (5.73 lb/ft²) heat trapped below the birds can build up very quickly. Increased bird temperatures will result in higher levels of panting, reduce feed intake and subsequent decreases in daily gains. Higher levels of panting indicate energy required for growth is being used for heat dissipation resulting in increased feed conversions. Do not use stocking densities higher than 42 kg/m² because flock heat removal by the ventilation system becomes very difficult.

Stocking densities above 28 kg/m² (5.73 lb/ft²) require the stockman to constantly monitor bird behavior, feed intake and internal bird temperature. Adjustments in air exchange rates, air velocity and house set points need to be made to ensure the bird comfort. These adjustments depend on whether the house has tunnel ventilation capabilities and does not consider the 'wind chill factor'.

Always observe bird behavior and measure internal body temperature before deciding to adjust house set point temperature.

Temperature Guidelines Based on Stocking Density

Density kg/m ²	Target Temperature Range (°C)	Density (lb/ft ²)	Target Temperature Range (°F)
28	22 to 24	5.73	72 to 75
30	21 to 23	6.14	70 to 73
32	20 to 22	6.55	68 to 72
34	19 to 21	6.96	66 to 70
36	18 to 20	7.37	64 to 68
38	17 to 19	7.78	63 to 66
40	16 to 18	8.19	61 to 64
42	15 to 17	8.60	59 to 63
42+	14 to 16	8.60+	57 to 61



Animal Welfare Tips

Activity Check: Every time you enter a poultry house you should always observe the following activities:

- Birds eating
- Birds playing
- Birds drinking
- Birds chirping
- Birds resting
- Birds should never be huddling

5.3 Lighting Programs

Lighting programs are an important management tool for good broiler performance and flock welfare. Lighting programs are typically designed with changes occurring at predetermined ages and tend to vary according to the final target market weight of the broilers. Research indicates that lighting programs which include 6 hours of continuous darkness will improve the development of the immune system. One standard lighting program will not be successful for all parts of the world. Therefore, the lighting program recommendations listed in this guide should be customized based on the environmental conditions, house type and overall stockman objectives. Lighting programs inappropriately employed may impair average daily gain (ADG) and compromise flock performance and reduce welfare. Careful observations of flock performance, nutrient density and feed and water intake are also important in designing lighting programs. Accurate ADG information is needed to optimize a lighting program.

Light Intensity and Distribution

The intensity and distribution of light alters broiler activity. Correct stimulation of activity during the first 5 to 7 days of age is necessary for optimal feed consumption, digestive and immune system development and good welfare. Lighting programs can be adjusted to improve feed efficiency.

Uniform distribution of light throughout the house is essential to the success of any broiler lighting program:

- ✓ Light intensity - 25 lux (2.5 fc) in the darkest part of the house, as measured at chick height, should be the minimum used during brooding to encourage early feed intake and early weight gains.
- ✓ Light intensity should not vary more than 20 % from brightest to darkest place at floor level.
- ✓ When birds weigh between 130 to 180 g (0.29 to 0.40 lb), light intensities can be reduced gradually to 5 to 10 lux (0.5 to 1 fc) unless local legislation prohibits this reduction.

Lighting Program Benefits

- ✓ A period of darkness is a natural requirement for all animals.
- ✓ Energy is conserved during resting, leading to an improvement in feed conversion.
- ✓ Mortality and skeletal defects are reduced.
- ✓ The light/dark period increases melatonin production, which is important for immune system development.
- ✓ Bird uniformity is improved.
- ✓ Growth rate can be equal to or better than that of birds reared on continuous light when compensatory gain is attained.

Note: Lowering light intensity below 5 lux (0.5 fc) during the growing phase to improve feed conversion ratio (FCR), risks the reduction of daily feed consumption and a decrease in the average daily gain.



Animal Welfare Tips

Local government legislation may affect the lighting program that can be used. All operations must comply fully with local animal welfare regulations. Birds with the adequate dark/rest period have a calmer behavior and fewer incidences of crowding, scratches and flightiness when broilers are stimulated by the sound of the feeder.

Examples of Four Lighting Programs

Standard Lighting program - Option 1

Slaughter weight: <2.5 kg (5.5 lb)

Age (days)	Hours of dark
0	0
1	1
130 to 180 g	6
Five days before processing	5
Four days before processing	4
Three days before processing	3
Two days before processing	2
One day before processing	1

Standard Lighting program - Option 3

Slaughter weight: 2.5 kg to 3.0 kg (5.5 to 6.6 lb)

Age (days)	Hours of dark
0	0
1	1
130 to 180 g	8
21	7
28	6
35	5
42	4
49	3
Three days before processing	3
Two days before processing	2
One day before processing	1

Standard Lighting program - Option 2

Slaughter weight: <2.5 kg (5.5 lb)

Age (days)	Hours of dark
0	0
1	1
130 to 180 g	6
21	5
28	4
35	3
Two days before processing	2
One day before processing	1

Standard Lighting program - Option 4

Slaughter weight: >3.0 kg (6.6 lb)

Age (days)	Hours of dark
0	0
1	1
130 to 180 g	10
22	9
28	8
35	7
42	6
49	5
Five days before processing	5
Four day before processing	4
Three days before processing	3
Two days before processing	2
One day before processing	1



Animal Welfare Tips

Implementing a step-down program to reduce the hours of darkness prior to catching can be beneficial for the welfare of the broiler flock. Since catching and transport may take place during daylight hours, this change in the lighting program will help broilers acclimate during these last few days on the farm. Broilers will be less stressed, less flighty, and will be more likely to eat and drink throughout the day when lights are on.

Key Points to Consider When Using a Lighting Program

- ✓ Thoroughly evaluate any lighting program before implementing.
- ✓ Provide 24 hours light on the first day of placement to ensure adequate feed and water intake, and to encourage chick activity within the brooding area.
- ✓ Turn the lights off the second night for one hour to establish when the off time will be. Once set, the off time must never change for the life of the flock and any changes to the lighting program should be by adjusting the on time only.
- ✓ Use a single block of darkness in each 24-hour period.
- ✓ Start increasing the dark period when the birds reach 130 to 180 g (0.29 to 0.40 lb).
- ✓ If partial house brooding is practiced, delay dimming until the entire house is used.
- ✓ Allow the birds to feed ad libitum to ensure they go into the dark period full of feed and water and can eat and drink immediately when the lights turn back on. This helps prevent dehydration and reduces stress. Birds will acclimate to the off time and will eat and drink before the lights go off.
- ✓ When possible, the dark period should coincide with night to ensure the dark periods are truly dark.
- ✓ Inspection of the flock should take place during the day when there is adequate light inside the house and the flock is active.
- ✓ The birds should be weighed at least weekly on days that the lighting program is scheduled to be adjusted. The lighting program should be adjusted according to the average weight of the birds. Past farm performance should also be considered.
- ✓ The length of the dark period should be increased in single steps and not in gradual hourly increases (see lighting program examples). The reduction in dark hours can be done in hourly increments.
- ✓ Reducing the dark period before catching reduces ‘flightiness.’
- ✓ If progressive thinning is practiced it is good policy to reintroduce 6 hours of darkness the first night after partial depopulation.
- ✓ Reduce the darkness in times of warm weather if the birds are exposed to heat stress during the day and feed intake has been reduced.
- ✓ In winter, especially in cold climates, coincide the off time with dusk so the birds are awake during the coldest part of the night.
- ✓ In summer, the on time should coincide with sunrise to encourage feed intake before the peak heat of the day.
- ✓ Make sure that there are no drafts or wet litter at the end of the house where pans are installed. This could result in empty feeding systems leading to panic and scratching when lights are switched on.
- ✓ Do not turn the feed and water off during the dark period.
- ✓ If possible, use a dawn to dusk dimming system to prepare the birds for the on/off periods.
- ✓ Broiler farmers with clear curtain housing have limited alternatives. They need to design their lighting programs to coincide with natural daylight.
- ✓ 48 hours prior to catch, increase light intensity to 10 to 20 lux (0.1 to 0.2 fc) to acclimate the birds to catching - only necessary if daylight catching is practiced!



Learn more about LED lighting by downloading our white paper at <https://www.cobb-vantress.com/resource/white-papers>



Animal Welfare Tips

If your local Code of Practice or supply chain agreements require windows for natural lighting, higher intensity (> 20 lux) for the lighting period, or a longer darkness period, please consult your Cobb broiler specialist for practical tips and help.

Nutrition Management

Broiler diets are formulated to provide the energy and nutrients essential for healthy and efficient broiler production. The basic nutritional components required by the birds are water, amino acids, energy, vitamins and minerals. These components must work jointly to assure correct skeletal growth and muscle deposition. Ingredient quality, feed form and hygiene directly affect the contribution of these basic nutrients. If raw ingredients or milling processes do not meet quality standards or there is an imbalance in the nutrient profile of the feed, performance can be decreased. Because broilers are grown to a wide range of end weights, body compositions and production strategies, it is impractical to present a single set of nutritional requirements. Therefore, any expression of nutrient requirements should only be viewed as a set of guidelines from which to work. These guidelines must be adjusted as necessary to address specific scenarios from one producer to another.

Diet formulation should take into consideration these key factors

- ✓ Raw material availability and cost.
- ✓ Separate sex growing.
- ✓ Live weight and growth rate required by the market.
- ✓ The value of meat and carcass yield.
- ✓ Fat levels required by specific market needs such as oven-ready, cooked and further-processed products.
- ✓ Skin color (as required by market needs).
- ✓ Meat texture and flavor.
- ✓ Feed mill capabilities.

Feed form may be prepared as a mash, crumble, pelleted or extruded product. Blending the manufactured feed with whole grains prior to feeding is also common in some areas of the world. Further processing or pelleting of feed is often preferable as there are both nutritional and managerial benefits. Pelleted or extruded diets are easier to handle when compared to mash feeds. Nutritionally, pellet feed shows a noted improvement in flock efficiency and growth rates when compared with mash feeds.

Crude Protein

The broiler requirement for crude protein actually describes the requirements for amino acids, the building blocks of protein. Proteins are found as structural components in tissues ranging from feathers to muscle.

Energy

Energy is not a nutrient but describes the metabolism of energy yielding nutrients. Energy is necessary for maintaining the bird's basic metabolic functions and body weight growth. Traditionally, the metabolizable energy system has been used to describe the energy content of poultry diets. Metabolizable energy (ME) describes the gross energy of a feed consumed less the gross energy excreted.

Micronutrients

Vitamins are routinely supplemented in most poultry feeds and can be classified into either water-soluble or fat-soluble. Water-soluble vitamins include the B-complex vitamins. Vitamins classified as fat-soluble include A, D, E and K. The fat-soluble vitamins can be stored in the liver and other parts of the body.

Minerals are inorganic nutrients and are classified as major or trace elements. The major minerals include calcium, phosphorus, potassium, sodium, chlorine, sulfur and magnesium. Trace minerals include iron, iodine, copper, manganese, zinc and selenium.

Feed Testing

A systematic approach to feed sampling on the farm is a 'best practice' policy. A good feed sampling technique is important if the results of the analysis are to reflect the real nutrient content of the feed. A sample must be representative of the feed from which it was taken. This cannot be achieved by 'grabbing' a sample of feed from the trough or pan. In order to collect a representative feed sample it is necessary to take sub-samples and combine them into a composite sample. It is recommended that five sub-samples (equivalent amounts) from each delivery of feed be taken. Sampling from the feed lines is not recommended as sifting of ingredients or fine particulates will skew results. Samples should be stored in a refrigerator until the flock is processed. Each sample should be recorded with the date, feed type and delivery ticket number. If problems arise during production and feed is suspected, samples should be analyzed. Lab reports should be compared with nutrient specifications for the respective diets.

Phase Feeding

Nutrient requirements generally decline with increasing broiler age. From a classical standpoint, starter, grower and finisher diets are incorporated into the growing program of broilers. However, bird nutrient requirements do not change abruptly on specific days, but rather they change continuously over time. Most companies feed multiple formulations of feed in an attempt to match bird nutrient requirements. The greater the number of feeds a bird receives, the closer the farmer can feed birds to the requirement. The number of feeds is limited by economic and logistical factors, including feed mill capacity, transportation costs and farm resources.

Dietary nutrient concentrations are based on the objectives of the poultry company. There are three main objectives of feeding broilers and most poultry companies use a combination of these.

Diet Type 1

Nutrient-rich to optimize live weight gain and feed conversion. This approach may promote additional carcass lipid content. In addition, diet cost will be high.

Diet Type 2

Lowered energy content but optimal crude protein and amino acid content. This approach will result in less lipid gain but maximize lean mass production. Live weight and feed conversion will be negatively affected but cost per lean mass will be optimal.

Diet Type 3

Low nutrient concentration. This approach will result in lower live weight growth and higher feed conversion but cost per live weight may be optimum.

Feed Withdrawal

During this period, special attention should be directed towards medication withdrawal dates to ensure there is no residue retained in the carcass at processing. Carefully kept records are essential.



Supplemental Whole Wheat Feeding

Feeding supplemental whole wheat to broiler chickens is practiced in many countries around the world. Benefits include a reduction in feed cost and therefore cost per kg (lb) of live weight, improvements in gizzard development resulting in improved digestive efficiency and the ability to adjust the nutrient intake on a daily basis if necessary. Possible disadvantages are reduced growth rate, reductions in lean gain and poorer uniformity if adjustments to the compound feed are not made.

Supplemental wheat may be added either at the feed mill or at the farm. While adding whole wheat at the farm is preferable due to the increased flexibility, this requires an on-farm feed proportioning system as well as additional bulk bins. At the feed mill, whole wheat may be added in the mixer or during the loading of the feed truck. Adding the whole wheat at the feed mill also allows for the potential of some processing, if available, such as roller milling.

When birds weigh around 160 g (0.35 lb), supplemental whole wheat can be added at a level of 1 to 5 %. This can be increased up to approximately 30 % using gradual increases of 1 to 5 %. The maximum percent used will depend on the compound feed quality and nutrient density, wheat quality and the performance of the individual flock.

It is important to consider the dilution effect of adding supplemental whole wheat to the diet. Any medications will need to be adjusted to ensure they are fed at the correct levels. Regular monitoring of bird live weight is important to determine the effect whole wheat addition has on a particular flock. The supplemental whole wheat should be removed 48 hours before slaughter. Wheat can slow the passage of feed through the intestinal tract. Therefore removing wheat 48 hours before slaughter may increase the feed passage rate and may help to reduce any contamination of the carcass during evisceration.



7

Water Management

7.1 Mineral Content

Although broilers are tolerant of high levels of some minerals, (calcium and sodium, for example), they are very sensitive to the presence of others. Iron and manganese tend to give water a bitter taste that may decrease consumption. In addition, these minerals support the growth of bacteria and can cause significant mineral buildup in the water lines. If iron is a concern, filtration systems and chlorination are effective controls. It is advisable to filter the water supply using a filter with a mesh of 40 to 50 microns. The filter should be checked and cleaned at least weekly.

Calcium and magnesium in the water are measured by hardness. These minerals in combination can form scale or deposits that will compromise

the effectiveness of a drinker system. This is especially true of closed drinker systems. Water softeners can be incorporated into a system to mitigate calcium and magnesium impacts. However, sodium levels should be assessed before a salt-based, water softener product is used.

Broiler performance can be impeded by as little as 10 ppm of nitrates. Unfortunately, there are currently no cost-effective options for nitrate removal from drinking water. Water should be tested for nitrates because elevated levels may indicate sewage or fertilizer contamination.

Oxidation-Reduction potential (ORP) chlorination value

Another important factor is the ORP value of the water which refers to the property of chlorine sanitizers to be a strong oxidizer. A strong oxidizer kills and destroys viruses, bacteria and other organic material present, leaving water microbiologically safe. An ORP value in the range of 650 mV or greater indicates good quality water. A lower the value indicates a heavy organic load that will most likely overwhelm the ability of chlorine to disinfect the water.



The ORP meter can be a useful tool for identifying and maintaining adequate chlorine supplies without overusing chlorine.



Animal Welfare Tips

Birds will consume most of their daily water requirements 2 to 3 hours after eating. A drop in consumption could indicate a restriction or supply issue. Adequate water storage and supply capacity are key to prevent shortages. Evaluate daily total water consumption and bird behavior in each house. If there are any dramatic and unexpected changes in daily water consumption, evaluate the reason(s). Possible items to investigate include: feed (quality and amount consumed), temperature, drinker maintenance (pressure, flow rate, leaks, air blockages, stray voltage), water quality, and bird health status.

Chlorine

- ✓ Swimming pool chlorine test kits do not distinguish between free and bound chlorine. Although these test kits might indicate chlorine levels of 4 to 6 ppm, a heavy organic load could still be present with bound chlorine. In this case, there is no free chlorine available to act as a sanitizer.
- ✓ Chlorine is most effective when used in water with a pH of 5.0 to 6.5. This pH level results in a greater percentage of active hypochlorous ions which are a strong sanitizer.
- ✓ Inorganic acids such as sodium bisulfate reduce water pH without tainting the water.
- ✓ Free chlorine residual levels are not considered useful as sanitizers unless there is at least 85 % hypochlorous acid present.

pH

- ✓ pH is the measure of how many hydrogen ions are in solution and is measured on a scale of 1.0 to 14.0 with 7.0 being neutral. A pH value below 7.0 indicates an acid while numbers above 7.0 indicates an alkaline.
- ✓ pH above 8.0 can impact taste by causing bitterness, thus reducing water consumption.
- ✓ High water pH can be reduced by using inorganic acids. Organic acids can also negatively affect water consumption and are discouraged.
- ✓ pH impacts water quality and the effectiveness of disinfectants such as chlorine.
- ✓ At a pH above 8.0, the chlorine is present mainly as chloric ions, which have very little sanitizing quality.

The most common sources of chlorine include:

- ✓ Sodium hypochlorite (NaOCl, household bleach) increases water pH so it is a poor option as a water sanitizer.
- ✓ Trichlor (trichloro-s triazinetrione) which contains 90 % available chlorine and is in the form of tablets and slowly releases chlorine over time. These reduce water pH providing a good option as a water sanitizer.
- ✓ Chlorine gas is available as 100 % chlorine and is the purest form of chlorine, but it can be dangerous and is restricted in its use.

Impact of pH on the ratio of hypochlorous (HOCL) to chloric ion (OCL)		
pH	% Hypochlorous Acid - HOCl	% Hypochlorite Ion - OCl
8.5	10	90
8.0	21	79
7.5	48	52
7.0	72	28
6.5	90	10
6.0	96	4
5.0	100	0

The ideal drinking water pH for a disinfection water program is between 5 to 6.5

7.2 Microbial Contamination

Chronically poor performance may indicate contaminated water and requires immediate testing. When testing water, evaluating the total coliform bacterial count is important, as high levels can cause disease. Evaluating the total bacteria with a total plate count will reflect the effectiveness of the water sanitation program. Microbial contamination can be introduced from the original water source and at any point in the water delivery system. If an effective water sanitation program is not in place, growth of bacteria will readily occur.

Test the water if there is (are)

- ✓ a noticeable change in color, odor or taste
- ✓ flooding that has occurred near the well
- ✓ a person or animal that becomes sick from waterborne disease on the premises
- ✓ maintenance on the water supply system
- ✓ flocks that have persistently poor performance
- ✓ a major loss of flow or pressure in water system

7.3 Total Dissolved Solids

Total dissolved solids (TDS) describes the inorganic salts and organic matter present in solution in water. Calcium, magnesium and sodium salts are the primary components that contribute to TDS. High levels of TDS are the most commonly found contaminants responsible for causing harmful effects in poultry production. The table right, provides guidelines for the suitability for poultry water with different concentrations of total dissolved solids (TDS), which are the total concentration of all dissolved elements in the water.

Suitability of water with different concentrations of total dissolved solids (TDS)	
TDS - ppm	Comments
Less than 1,000 1,000 to 2,999	Water suitable for poultry. Water suitable for poultry. It may cause watery droppings (especially at higher levels) but with no effect on health or performance.
3,000 to 4,999	Water not suitable for poultry. Can cause watery droppings, increased mortality, and decreased growth.
5,000 to 6,999	Water not suitable for poultry. At the upper limits, decreased growth and production or increased mortality are more likely.
7,000 to 10,000	Water unfit for poultry but may be suitable for other livestock.
More than 10,000	Water should not be used for any livestock or poultry.

7.4 Drinking System Cleanout Between Flocks

1. Determine the capacity of the drinking system.
2. Drain drinking system and vaccination (doser) tanks.
3. Where possible, remove vaccination (doser) tank and scrub it clean. If using a gravity fed header tank for vaccination, drain and clean.
4. Prepare the cleaning solution to the manufacturer's recommendation. Make sure protective clothing and eyewear are worn when using chemicals.
5. Introduce the cleaning solution into the water system.
6. Turn on the tap at the end of the drinking line and let the water run through until the cleaning solution appears, then close the end tap.
7. Raise each drinker line.
8. Allow the solution to fill the drinking system.
9. Let the cleaning solution stand for at least 12 hours.
10. After draining the system, flush the system thoroughly to remove biofilm and cleaning chemical.

7.5 Water Sanitation and System Cleanout

A regular water sanitation and water line cleaning program can provide protection against microbial contamination and the buildup of biofilms in water lines. While biofilms may not be an immediate source of problems to birds, once established in water lines, biofilms provide protection for bacteria and viruses from disinfectants. They can also trap organic material, a food source for microorganisms. Poultry products in water lines (vitamins, electrolytes, organic acid, vaccines, vaccine stabilizers, antibiotics and probiotics) can all contribute to the growth of a biofilm. As a result, special attention to internal drinker line cleanliness should be initiated after using these products.

Products containing hydrogen peroxide are proven effective at removing biofilms in water lines. Potassium peroxymonosulfate (also known as MPS, KMPS, potassium monopersulfate, and potassium caroate) are non-chlorine oxidizers that are also effective against biofilms.

7.6 Water Testing

Water testing should be performed on a periodic basis but at least yearly. Samples should be collected at both the water source and at the end of a drinker line using a sterile container and analyzed at an accredited laboratory (see table on following page for specifications of mineral contents present in water samples).

It is important not to contaminate the water sample during collection. Sterilize the end of the tap or nipple by using an open flame for 3 seconds (always take extra precaution when using an open flame). Never use a chemical to sterilize a nipple as it may affect the sample. As an alternative to an open flame, run the water for a few minutes before taking the sample.



Biofilms and organic material can build up in water lines over time leading to reduced water flow.

Contaminant, mineral or ion	Level Considered Average	Maximum Acceptable Level	Comments and Treatments
Bacteria			
Total bacteria	0 CFU/ml	100 CFU/ml	Total Bacteria is an indicator of system cleanliness, high numbers do not indicate harmful bacteria are present but it increases the risk of pathogenic organisms. High bacteria levels can impact taste of water resulting in reduced consumption by birds.
Coliform bacteria	0 CFU/ml	0 CFU/ml	Presence of any fecal coliform means water is unfit for consumption by poultry or humans.
Acidity (pH)	6.8 to 7.5	7.6	pH below 5 can be harmful to drinker equipment by causing corrosion to metal components (long term exposure). pH above 8 impacts the effectiveness of water sanitizers and is also associated with high alkalinity which may cause reduced water consumption in poultry due to "bitter" taste.
Total hardness (Ca and Mg)	60 to 180 mg/L	See comments	Hardness causes scale which can reduce pipe volume and make drinkers hard to trigger or leak. Hardness of water is classified as follows: 0 to 60 mg/L - soft water; 61 to 120 mg/L - moderately hard water; 121 to 180 mg/L - hard; and >180 mg/L - very hard.
Naturally occurring elements			
Calcium (Ca)	60 mg/L	N/A	No upper limit for calcium, birds are very tolerant of calcium. If values are above 110 mg/l may require water softener, polyphosphates or acidifier to prevent scaling.
Chloride (Cl)	14 mg/L	250 mg/L	When combined with high sodium levels, creates saline water that can act as a laxative causing flushing. Salty water can promote the growth of <i>Enterococci</i> which may cause enteric issues. Saline water can damage reproductive tract in breeder birds causing shell quality issues. Treatment- reverse osmosis, lower dietary salt levels, blending with non-saline water. Keep water clean and use daily sanitizers such as hydrogen peroxide or iodine to prevent microbial growth.
Copper (Cu)	0.002 mg/L	0.6 mg/L	
Iron (Fe)	0.2 mg/L	0.3 mg/L	Birds tolerant of iron metallic taste but high iron causes leaking drinkers and promotes the growth of <i>E. coli</i> and <i>Pseudomonas</i> . Treatment includes oxidation with chlorine, chlorine dioxide or ozone followed by filtration.
Lead (Pb)	0	0.02 mg/L	Long term exposure can cause weak bones and fertility problems in breeders.
Magnesium (Mg)	14 mg/L	125 mg/L	Higher levels of Mg may cause flushing due to laxative effect particularly if high sulfate levels are present.
Manganese (Mn)	0.01 mg/L	0.05 mg/L	Can cause black grainy residue on filters and drinkers. Manganese can promote bacterial growth. In the bird, manganese may interfere with copper uptake and utilization. Treatment includes oxidation with chlorine, chlorine dioxide or ozone at a pH of 8 followed by filtration. Green sand filtration is an option.
Nitrate	10 mg/L	25 mg/L	If nitrates convert to nitrites, poor growth and feed conversion can occur due to the nitrites binding blood hemoglobin. Presence of nitrates may indicate fecal contamination so also test for bacteria. Can be removed with reverse osmosis.
Sodium (Na)	32 mg/L	50 mg/L	When combined with high chloride levels, creates saline water that can act as a laxative causing flushing. Salty water can promote the growth of <i>Enterococci</i> which may cause enteric issues. Saline water can damage reproductive tract in breeder birds causing shell quality issues. Treatment- reverse osmosis, lower dietary salt levels, blending with non-saline water. Keep water clean and use daily sanitizers such as hydrogen peroxide or iodine to prevent microbial growth.
Sulfate	125 mg/L	250 mg/L	Sulfates can cause flushing in birds. If rotten egg odor present in water, then hydrogen sulfide producing bacteria are present and system will require shock chlorination as well as the establishment of good daily water sanitation program. Sulfates can be removed by aerating water into a holding tank, treatment with hydrogen peroxide, chlorine or chlorine dioxide then filtration. With elevated sulfate levels, hydrogen peroxide is preferred since it requires an almost 2 to 1 ratio of sanitizer to sulfate for oxidation.
Zinc	N/A	1.5 mg/L	No known issues.

Energy Efficient House Design

There are many things to consider when selecting the most suitable type of broiler housing and related equipment. Though economic constraints are generally foremost, factors such as equipment availability, post-installation service and expected life of the equipment are also critical. Housing should be cost and energy efficient, durable and provide a controllable environment.

When planning the construction of a broiler house, select a well-drained site that has plenty of air movement. The house should be oriented on an east-west axis to reduce the heat from direct sunlight during the hottest part of the day, and temperature fluctuation during any 24-hour period. Good temperature control always enhances feed conversion, bird comfort, and average daily gain.



Five key components of any broiler house:

1. A well-insulated, well-sealed roof.
2. A heating system that has sufficient capacity to maintain temperatures during the coldest part of the year.
3. A minimum ventilation system in combination with a circulation fan system to manage litter moisture and air quality. Sufficient fan capacity to cool the birds.
4. A dim-able lighting system providing uniform light distribution (LED lighting is preferred).
5. Energy efficient choice of the above components: insulation, fans, heating and lighting systems.

8.1 Roof Design and Insulation

A consistent and energy efficient environment is essential to maximize bird performance. Roof design and its insulation are probably the most important part of a broiler house.

A well-insulated roof will reduce solar heat penetrating the house on warm days, and in cold weather, will reduce heat loss and energy consumption required to maintain the house target temperature, especially during brooding.

The insulation properties of materials are a function of the capacity to limit energy transfer through conduction or convection measured with an R and U value. The higher the R-value the greater the insulating properties of the material. When selecting any insulation material, the most important consideration is cost per R-value unit rather than cost per thickness of material. The roof should be insulated to a minimum R-value of 20 to 25 (climate dependent).

U value - coefficient of heat transmission, is a measure of the rate of non-solar heat loss or gain through a material. U-values gauge how well a material allows heat to pass through. The lower the U-value, the greater a product's resistance to heat flow and the better its insulating value. The inverse of the U-value is the R-value. The required roof U-value is 0.05 to 0.04 (climate dependent).

Insulating materials and their respective R-values

Insulation Thickness (cm) for R20 (*SI R3.5)	Insulating Material	R-Value (US) per 2.5 cm (1 in)
16.7	Expanded polystyrene (beadboard)	3.0
16	Cellulose Blown	3.2
16	Fiberglass batt	3.2
10	Polystyrene, extruded plain (pink board)	5.0
7	Polyurethane foam, un-faced	7.0



Expanded Polystyrene



Cellulose Blown



Fiberglass Batt

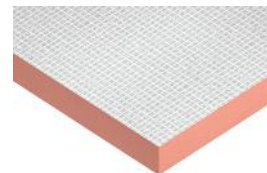

Polystyrene



Polyurethane foam

8.2 Curtain Installation

- ✓ Air tightness is the most important criterion when installing or maintaining curtains. The top of the curtain must overlap a solid surface to prevent air leaks by having an overlap of at least 15 cm (6 in). A 25 cm (10 in) mini curtain installed on the outside of the curtain will also help prevent air leaks over the top of the curtain.
- ✓ The curtains should fit into an envelope which is a 25 cm (10 in) mini curtain that seals the curtain vertically on both ends.
- ✓ Curtains need to be sealed at the base to prevent air leaks at floor level.
- ✓ All holes and tears in sidewall and/or inlet curtains must be repaired.
- ✓ The optimum stem wall height is 0.50 m (1.6 ft).



25 cm (10 in) mini curtain

25 cm (10 in) curtain envelope

8.3 Perimeter Inlet Installation

- ✓ Perimeter inlets in tunnel housing should be installed as close to the ceiling as possible – about 30 cm (12 in) below the sidewall eaves. If the ceiling has structural obstructions such as beams, a solid “air ramp” should be installed to provide a smooth surface for the attachment of the incoming “air jet”.
- ✓ All inlets require wind proofing covers on the outside of the house to help reduce the impact of wind on inlet operations and reduce direct light entering the house during the day.
- ✓ The inlet cover should be at least 30 % larger than the cross sectional area of the inlet to prevent static pressure drop created by the air jet turning.

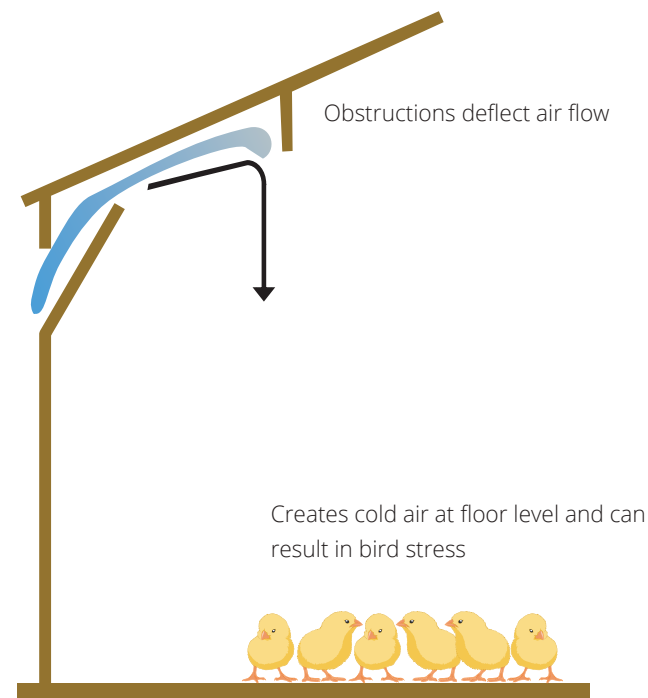
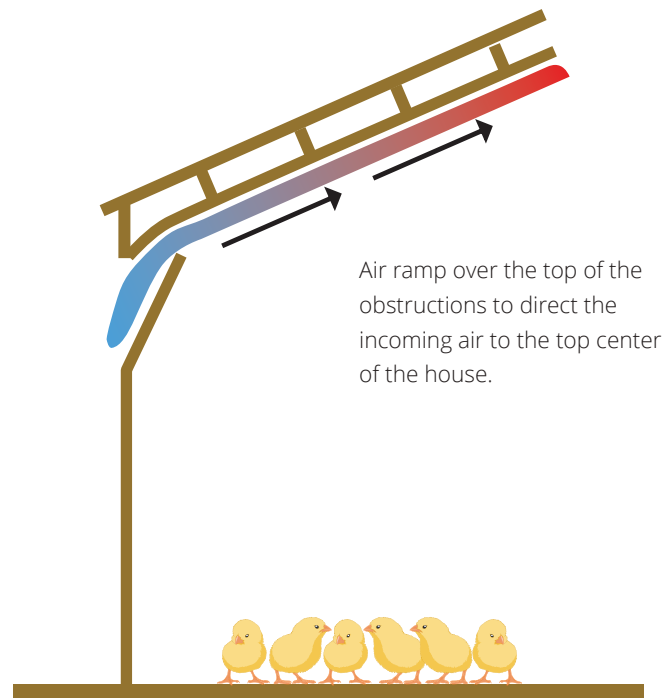

Animal Welfare Tips

Add a solid ramp to prevent obstructions that will result in cold air dropping to the floor. In addition to concerns about thermal-stress for broilers that are created with cold air falling to the floor, the deflected air flow can result in more moisture in the chicken house and wet litter. Ideally, air should be warmed before circulating to the floor so that optimal litter and air conditions are maintained and broiler comfort and skin (footpad, hock) condition are not negatively impacted.

Perimeter Inlet Installation (cont.)

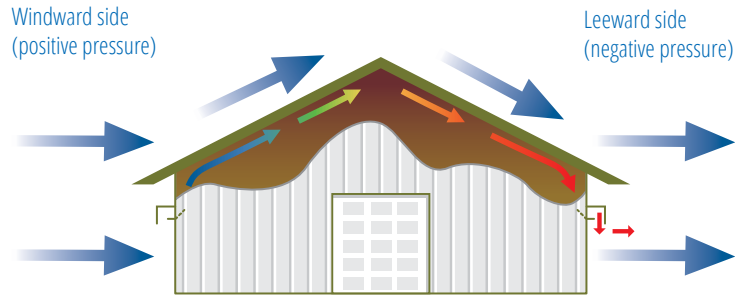

Wind will always create a negative pressure outside on the leeward side, and a positive outside pressure on the windward side. Wind proofing and well-sealed inlets are essential to prevent heat being drawn out of the leeward side of the house.

Without wind proofing, wind will interfere with the pressure control of the perimeter inlet system. Constant changes in pressure will cause the inlet drive unit to make excessive adjustments. The constant adjustments cause inconsistent inlet opening amounts affecting the ability of the incoming cold "air jet" to reach the center of the house and excessive wear and tear on the drive units. See minimum ventilation section for more details.

Houses over 100 m (330 ft) should have the inlet drive units installed in the center of the side wall to reduce any inlet opening variation. It is common for cables to stretch and twist and can cause variability in perimeter inlet openings. Solid 5 to 8 mm (0.2 to 0.3 in) steel rods eliminate any stretch and twisting. Often, inlets closer to the drive unit are open wider than those at the end of the house. Non-uniform openings can be minimized by ensuring sufficiently sized counter weights or springs. Guide pulley position and size are very important for efficient closing and sealing of inlets.

COBB BROILER MANAGEMENT GUIDE

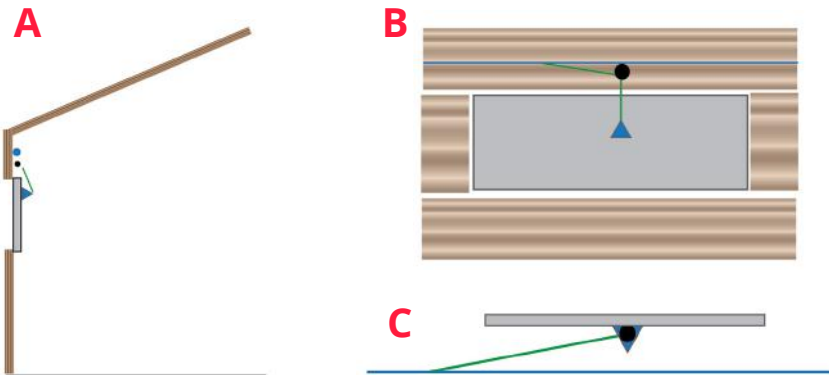

Correct placement of inlet cable and rod. A. Side view; B Front view; C Top view

● Guide pulley ● Cable/rod — Nylon cord



Animal Welfare Tips

During routine flock checks, observe the system to make sure inlets are opening and closing uniformly. Also evaluate bird behavior and distribution. If birds are huddling in a group, this may be related to cold-stress if incoming cold air is falling to the floor and chilling the broilers. Ideally, broilers should be distributed evenly throughout the area and expressing normal behavior.

8.4 Horizontal and Vertical Circulation Fan Systems

The primary function of a circulation fan system is to disperse the natural heat stratification in the house. It is not unusual to see up to 5 °C (25 °F) difference between the ceiling and floor level. These fan systems are designed to mix the air from the floor to ceiling by producing air movement at floor level between 0.25 to 0.76 m/s (50 to 150 fpm), removing moisture from the litter. There are two different circulation fan systems, horizontal or vertical. The horizontal circulation system requires a smooth roof or ceiling.

In wider high volume houses, a double row of circulation fans can be installed. The fan orientation can be similar to the illustration below or the fans can be used to create a “race track” effect with all fans facing in the same direction mounted on the widest side.

An example of a horizontal circulation fan system in a tunnel ventilated house

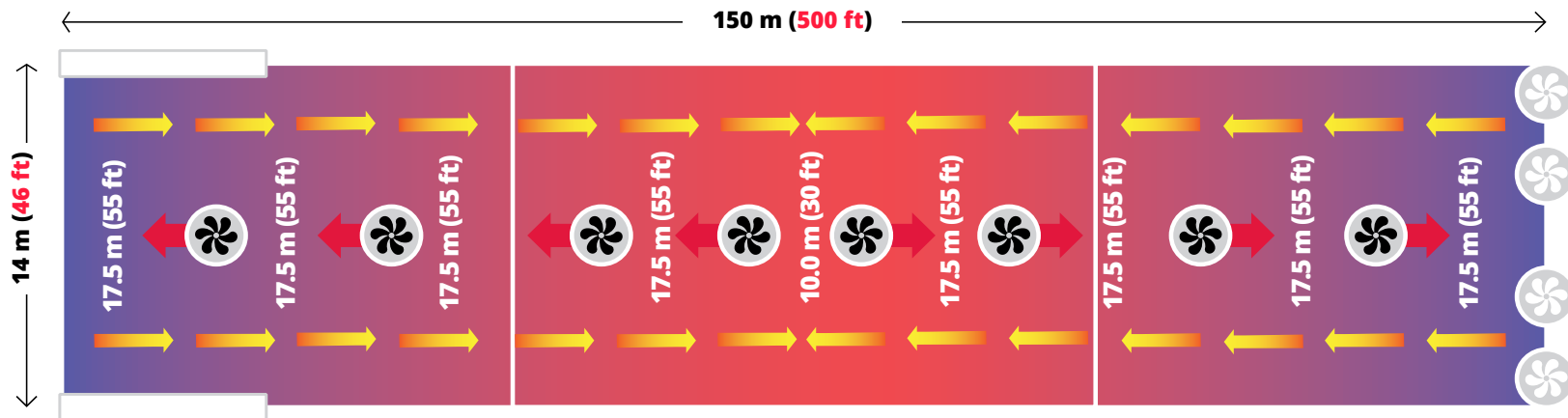

The large red arrows indicate high velocity movement at ceiling level, while the smaller yellow / orange arrows indicate the low velocity return created at floor level. Increasing circulation fan capacity will increase the “return” air movement at floor level. As long as the return is warm, moving warm air does not constitute as a draft! The more circulation capacity, the drier the litter.



Animal Welfare Tips

Circulation fans help with air mixing in the house and are important tools to help maintain dry litter throughout the house. Dry litter is important for maintaining good footpad health, providing broilers with a comfortable environment, and promoting positive bird behaviors.

Horizontal and Vertical Circulation Fan Systems (cont.)

Circulation fan requirements:

- ✓ Capacity: approximately 10 to 20 % house volume.
- ✓ Typical circulation fan size and capacity: 450 mm (18 in) fans with capacity of 70 m³/min (2500 cfm).
- ✓ In high ceilings and new tunnel ventilated houses, larger 600 mm (24 in) circulation fans with a capacity of 140 m³/min (5000 cfm) are being used.

Sample house dimensions

House dimensions: 150 m long, 14 m wide and 2.88 m average height

House dimensions: 500 ft long, 46 ft wide and 9.25 ft average height

Cross section: 14 m wide x 2.88 m average height = 40.3 m²

Cross section: 46 ft wide x 9.25 ft average height = 425 ft²

House volume: 150 m long x 14 m wide x 2.88 m average height = 6048 m³

House volume: 500 ft long x 46 ft wide x 9.25 ft average height = 212,750 ft³

Example of calculating how many fans needed for a horizontal circulation fan system

House volume X 10 % = Stir fan capacity

6048 m³ (212,750 ft³) × 10 % = 605 m³/min (21,275 cfm) stir fan capacity

Stir fan capacity ÷ Typical circulation fan capacity = number of fans needed

605 m³/min (21,275 cfm) ÷ 70 m³/min (2,500 cfm) = 8.6 or 9 fans



An illustration of a vertical circulation fan system. The thick red arrows show high velocity distribution and a thinner dashed red line shows the return air going back to the ceiling. The thick blue arrows indicate the cold air coming in through the perimeter inlets.

8.5 Tunnel Door Design

Design Considerations

Pad Height	1.8 m (6 ft)
Inlet Frame Height: >85 % Pad Height	>1.5 m (5 ft)
Inlet Frame Length = Pad Length Center	
Door Height	>1.5 m (5 ft)

Opening A from door to top of inlet frame always less than opening B

C should always be greater than A

- ✓ Always measure the tunnel door opening from the 90° position to the top frame of the inlet (A).
- ✓ Measuring from the top of the door to top of the frame (B), is not the true opening size.
- ✓ Always ensure when the door is at the fully open position, 45° to 60°, there is sufficient clearance between top of door and ceiling (C).
- ✓ If using tunnel inlet doors, they need to be well sealed along the perimeter. It is essential to ensure the house is air tight.
- ✓ The roof/ceiling of the cool pad house must be insulated.
- ✓ Each tunnel door should have its own drive unit. Suspension will depend on the system.

Tunnel Inlet Sizing – No Evaporative Pads

The tunnel inlet area will depend on the total tunnel fan capacity and the target velocity through the opening. Generally the target velocity is 2.9 m/s (575 fpm).

Formula: tunnel inlet area = fan capacity ÷ velocity

Tunnel Door and Inlet Design Example – 1.8 m (6 ft) Evaporative Pads

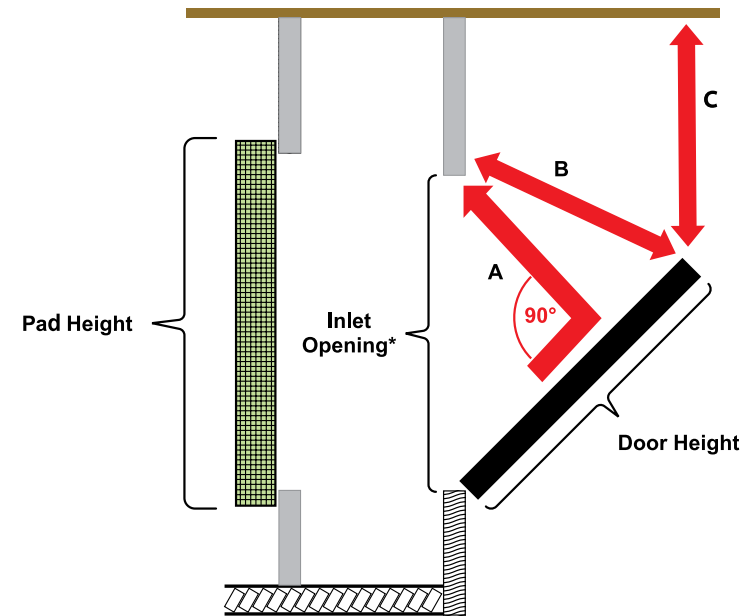

*Minimum door opening should be 85 % of pad height.

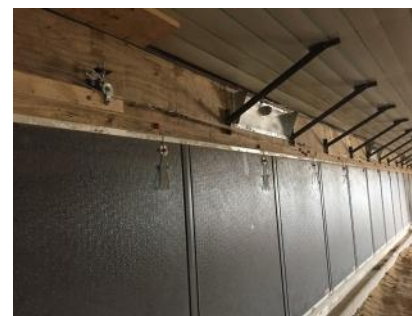

8.6 Evaporative Pad Design

The pad space surface area must match the fan capacity to ensure correct evaporation. The evaporative pads most suitable in the modern high speed house are 15 cm (6 in) with 45°/15° angle flutes with a 75 % cooling efficiency.

An optimal evaporative pad house design

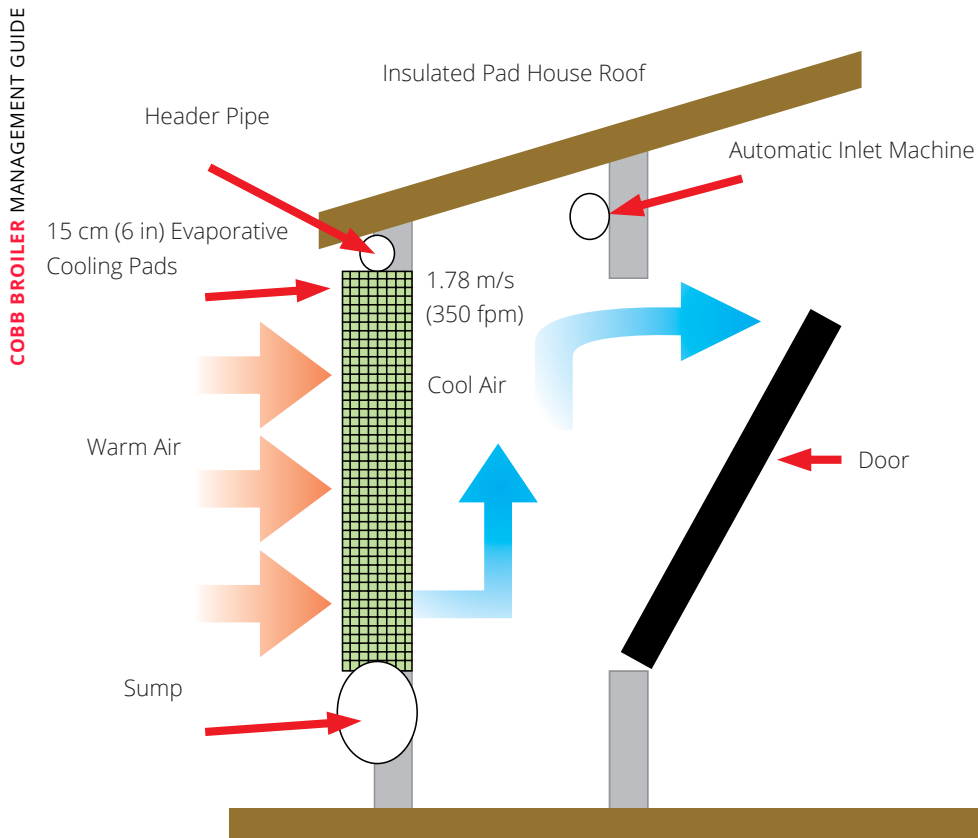

Important design requirements

- ✓ If using a curtain, it should be weighted. The curtain needs to be well-sealed at the bottom and at the edges - see section 8.2 on curtain installation.
- ✓ The cool pad house should be a minimum of 0.6 to 1 m (2 to 3 ft) wide to allow maintenance access and cleaning of the evaporative pad system.
- ✓ The water recovery system (sump) must be above ground to ensure easy access for cleaning and maintenance.
- ✓ Protect standing water in the sump recovery system from direct sunlight (sump lid) to reduce algae growth.
- ✓ Modern high speed houses with large evaporative pads should have the pumps installed in the middle of the pad to improve the wetting distribution of the pads.
- ✓ Do not place any structures or shading in front of cooling pads that will cause a pressure increase. The opening should match the pad area.
- ✓ The pad area should always be in line with the tunnel inlet opening.

Do not restrict the opening to evaporative pads - a restricted opening will cause unnecessary pressure increases!



Calculating the Evaporative Pad Area for a 3 m/s (600 fpm) Tunnel House

- ✓ **15 cm (6 in) evaporative pads should be sized at 1.78 m/s (350 fpm)**
- ✓ **Note: Always use fan capacity at an operating pressure of a minimum of 25 Pa (0.10 in wc) working capacity when calculating pad area requirement.**

Sample house dimensions

House dimensions: 150 m long, 14 m wide and 2.88 m average height

House dimensions: 500 ft long, 46 ft wide and 9.25 ft average height

Cross section: 14 m wide x 2.88 m average height = 40.3 m²

Cross section: 46 ft wide x 9.25 ft average height = 425 ft²

House volume: 150 m long x 14 m wide x 2.88 m average height = 6048 m³

House volume: 500 ft long x 46 ft wide x 9.25 ft average height = 212,750 ft³

Sample fans

- ✓ Example for broiler house: 3 m/s (600 fpm)
- ✓ 1270 mm (50 in), working capacity of 680 m³/min or 11 m³/s (24,000 cfm)
- ✓ Fan capacities used in the examples are rated at 25 Pa (0.1 in wc).

Step 1: Calculate required fan capacity

Fan capacity required to achieve an airspeed of 3.0 m/s (600 fpm)

inside the broiler house at 25 Pa (0.10 wc)

Required fan capacity = Cross section × Airspeed

40.3 m² × 3.0 m/s = 121 m³/s or 7,260 m³/min

425 ft² × 600 fpm = 255,000 cfm

Step 2: Calculate number of fans required

Number of 1.27 m (50 in) fans required:

7,260 m³/min ÷ 680 m³/min = 10.7 or 11 fans or

255,000 cfm ÷ 24,000 cfm = 10.7 or 11 fans

Step 3: Determine the total pad area required:

Total tunnel fan capacity ÷ 1.78 m/s (350 fpm)

(11 × 11.3 m³/s) ÷ 1.78 m/s = 70 m² pad area

(11 × 24,000 cfm) ÷ 350 fpm = 754 ft² pad area

70 m² ÷ 1.8 m (standard pad height) = 39 m of pad or 20 m per side

754 ft² ÷ 6 ft (standard pad height) = 126 ft of pad or 62 ft per side

8.7 Fogging Systems

Important design and installation requirements for tunnel ventilated houses:

- ✓ Fogger nozzle spacings will vary based on supplier.
- ✓ Nozzles should run from side wall to side wall.
- ✓ Lines can be spaced on 9 to 12 m centers (30 to 40 ft) – depending on the house structure.
- ✓ Position as many nozzles as possible in the first 30 m (100 ft) of house.
- ✓ Install nozzles on 2 separate circuits. Install the last fogger line 25 to 30 m (82 to 98 ft) from tunnel fans. This will prevent excessive dust collection on fan shutters and blades.
- ✓ One 500 W (3/4 hp) booster pump must be installed on the fogger system.
- ✓ A 2 cm (3/4 in) PVC schedule 40 water supply pipe - minimum.
- ✓ Each line must have a shutoff spring-loaded check valve (non-return valve) and flush lines.
- ✓ An automatic drain valve should be installed on each section to drain the water to the outside of the house when the pump is off. Drain valves will prevent dripping when the system is off.
- ✓ Foggers should start running at 28 °C (82 °F).
- ✓ The pump should be controlled by both temperature and relative humidity.
- ✓ Low pressure fogging systems operate at 7 to 14 bar (100 to 200 psi) producing a droplet size greater than 30 microns and delivering approximately 4 l/h (1 gal/h)
- ✓ High pressure fogging systems operate at 14+ bar (200+ psi) producing a droplet size of 10 to 15 microns.
- ✓ High pressure increases nozzle output by approximately 50 %. A 4 l/h (1 gal/h) nozzle will produce approximately 6 l/h (1.5 gal/h) at 14 bar (200 psi).
- ✓ Pump - mainline: 2 cm (3/4 in) pipe.
- ✓ Line - 1.25 cm (1/2 in) pipe.



In non-tunnel ventilated houses the high pressure fogging nozzles are installed along the perimeter wall just above the perimeter inlets. The number and capacity of the nozzles, will depend on the target temperature drop created through evaporative cooling



Animal Welfare Tips

Too much moisture from the nozzles can cause wet floors which can negatively impact air quality and litter quality for the flock.

High pressure fogging system installation for tunnel ventilated houses without evaporative pads

The fogging system has two separate circuits, for two stage cooling: green line indicates stage 1 and the blue line indicates stage 2

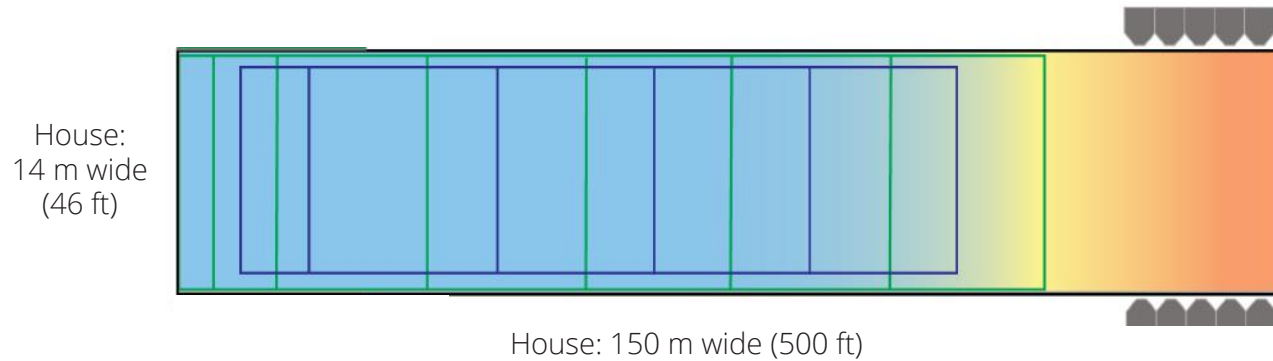

High pressure fogging system installation for tunnel ventilated houses with evaporative pads - 2 options

Used in extreme weather conditions and / or during catching.

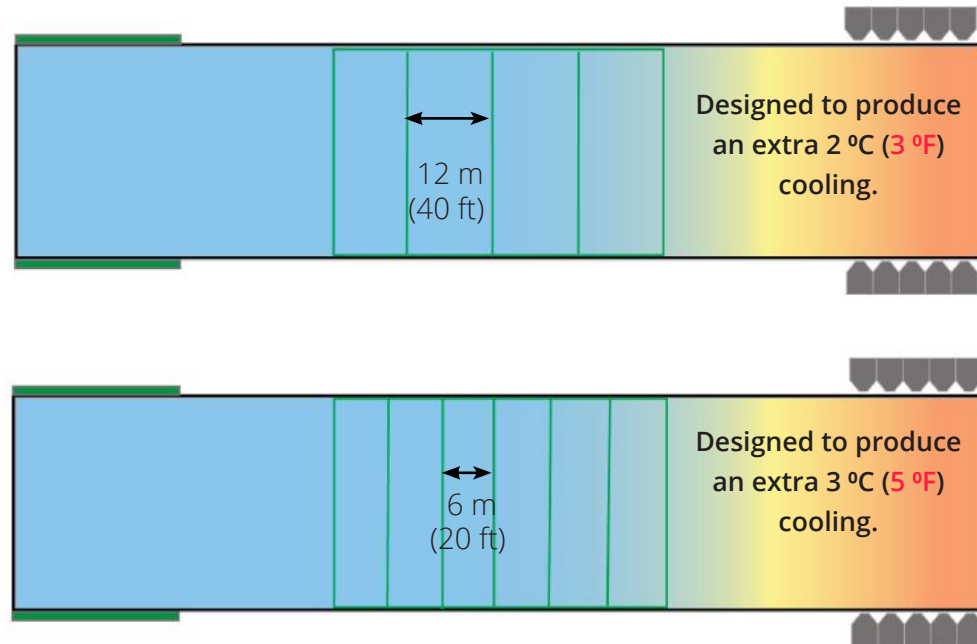

These are examples of 3 possible configurations that can be used in tunnel ventilated houses. The dimensions and nozzle amounts are approximations. The amount of cooling generated will depend on the water volume generated by the fogger nozzle, water droplet size, dry bulb temperature and relative humidity. The more nozzles the more cooling. Consult your equipment supplier for more detailed information.

8.8 Water Systems

Water Meters

Monitoring water consumption with water meters is an excellent means of gauging feed consumption, as the two are highly correlated. Water meters should be sized the same as the incoming water supply line to ensure adequate flow rate. Water consumption should be evaluated at the same time each day to determine general performance trends and bird well-being.

Water consumption per house should be recorded every 24 hours. Any substantial change in water usage should be investigated as this may indicate a water leak, health challenge or feed issue.

Install a water meter bypass used during flushing – water used during regular flushing procedures should not be included in the daily water intake reading.

Water meters and filters should also be installed upstream from the medicators



25 mm (1 in) medicator valves

25 mm (1 in) water meter

25 mm (1 in) pressure regulator

Water Storage Tanks and Farm Supply Layout

Adequate water storage should be provided on the farm in the event that the city or well system fails. The farm must have water storage equivalent to a 48 hour peak demand based on drinking water and evaporative and/or fogger system demands.

When designing or upgrading a farm, understanding water supply and layout is critical. Single and separate supply lines for the birds and the cooling systems should be installed sourced from the storage facility to each house. The line sizes should consider peak demands for both birds and cooling systems and the distance from the storage facility to the house.

Storage tanks should be housed in a separate insulated building or shaded and insulated.

If the source of water is a well or holding tank, the supply pump capacity should be sized to meet the birds and cooling systems, peak demands, and deliver a minimum of 2.8 bar (40 psi) to the broiler house control room.

The diagram is an example of the water supply layout for a broiler farm with 4 houses:

Pump pressure at source: 3.5 to 4 bar (50 to 60 psi)

A = 75 mm (3 in) pipe diameter and 300 l/min

B = 50 mm (2 in) pipe diameter and 150 l/min

C = 40 mm (1.5 in) pipe diameter and 75 l/min

Control room: 2.8 bar (40 psi) - minimum

Drinkers: 2 bar (30 psi)

— Drinker Supply

— Evap. Cooling Supply

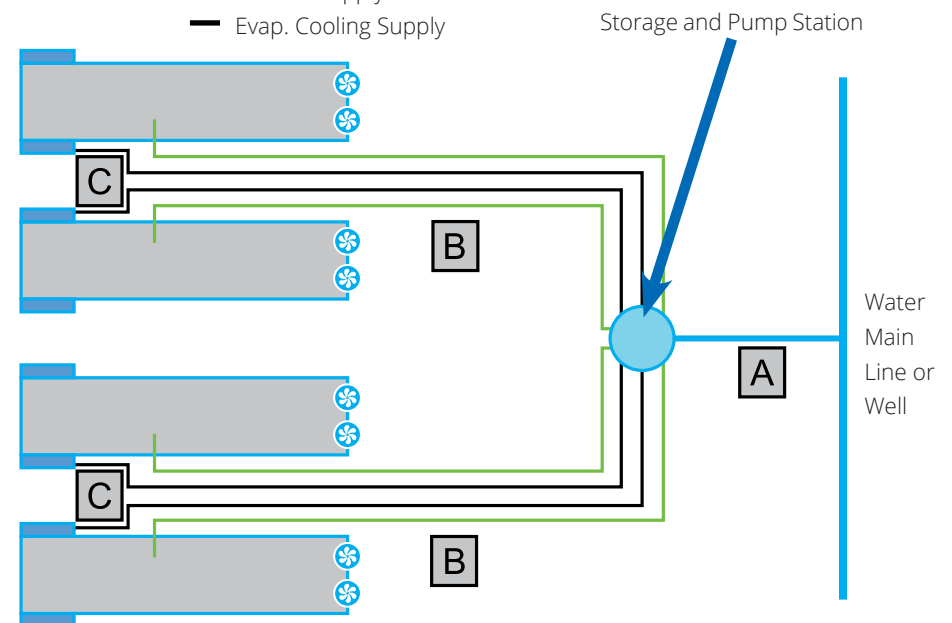

Animal Welfare Tips

All farms should have a primary and a secondary source of water to ensure that broilers always have a secure and sufficient source of water available for drinking and cooling needs. For example, if municipal water is the primary source for the farm, the farm should also have a backup or secondary source like a well or water storage tank. All water sources should be tested at least annually and when any major changes are made in water supply to verify water hygiene and quality requirements for bird health. Water kept in water storage tanks should be used regularly so that it will not become stagnant.

Sizing Guidelines for Water Lines Supplying Drinking and Evaporative Pad Systems

Estimated flow rates for different pipe diameters						
Pipe Diameter	20 mm (0.75 in)	25 mm (1.0 in)	40 mm (1.5 in)	50 mm (2.0 in)	65 mm (2.5 in)	75 mm (3.0 in)
Flow rate (l/min)	20	38	76	150	230	300
Flow rate (gal/min)	5.3	10.0	20.0	40.0	60.8	79.3

Evaporative cooling pad water supply requirements and cooling capacity are coupled with temperature and relative humidity. Understanding local conditions and ensuring the correct supply demands are especially important with high temperatures and low RH environments. The table (right) is an example of how evaporative pad water requirements increase with a drop in relative humidity percentage at 35 °C (95 °F) (outside temperature).

15 cm (6") Evaporative Pad Water Requirement at 35 °C (95 °F) Per 2832 m ³ /min (100,000 cfm)				
Humidity	50 %	40 %	30 %	20 %
Flow rate (l/min)	10	12	14	17
Flow rate (gal/min)	2.6	3.2	3.7	4.5

The following table illustrates differences in the evaporative pad water requirements for different sizes of tunnel ventilated broiler houses with air exchanges equivalent to 3 m/s (600 fpm). Pads evaporate 10 liters of water per 2832m³ of air volume (2.6 gal per 100,000 cfm) with outside temperatures and humidity of 35 °C (95 °F) and 50 % RH.

15 cm (6 in) Evaporative Pad Water Requirement									
House Width		Air Speed		Tunnel Fan Capacity		Number of Fans		Pad Requirement	
m	ft	m/s	fpm	m ³ /min	cfm	790 m ³ /min (28,000 cfm)		l/min	gal/min
12	40	3	600	6456	228,000	8		45	11.9
15	50	3	600	8093	285,800	10		53	14.0
18	60	3	600	9684	342,000	12		64	16.9
20	66	3	600	10653	376,200	13		72	19.0

9

Ventilation Management

To achieve optimal flock performance the ventilation system must provide optimal conditions in both cold and hot conditions. In cold weather and during brooding, the system must control moisture and air quality while also ensuring uniform and stable temperatures. During hot weather the ventilation system must provide sufficient cooling capacity to keep the birds as comfortable as possible. However, the house environment is dynamic with fluctuating temperatures, air quality and humidity levels which require constant monitoring and adjustments.

Managing poultry house humidity and litter moisture are two of the greatest challenges a producer may face. High house humidity during hot weather produces two challenges: it reduces the birds' thermoregulation ability and makes the management of litter moisture challenging.

During cold weather the challenge is to condition the incoming cold air before it circulates to bird level. Mixing the incoming cold air with the heat trapped at the ceiling is the most important concept the producer needs to successfully manage litter moisture.



Animal Welfare Tips

Airspeed and ventilation are very important tools to help maintain an ideal environment and a comfortable temperature for the flock. From a welfare viewpoint, always observe flock distribution and bird behavior when transitioning to different stages of ventilation. The birds will 'indicate' if they are comfortable (or not). Ideally, birds should be uniformly distributed in the house and remain active. If birds are migrating to one area, or still showing signs of heat stress, evaluate the operation of the ventilation system (incoming air speed, airspeed in the center of the house, inlet pressure, fan condition, etc.) and then fix any problems.

9.1 Minimum Ventilation

Minimum ventilation systems are designed to manage moisture and air quality using fans on a cycle timer. This system is independent of the temperature control and the minimum air exchange is linked to the amount of moisture added to the house by the birds, the drinking, heating system and ventilation systems. Under most conditions, maintaining good moisture control should ensure carbon dioxide levels are kept below 3000 ppm.

High levels of ammonia are usually associated with high house humidity and litter moisture. High levels of ammonia can increase the birds susceptibility to disease and potentially create a welfare issue. Additionally, raising birds on wet litter can lead to poor foot health and pododermatitis.

There are 3 key functions of ventilation:

1. Moisture and humidity control
2. Provide oxygen to meet the bird's metabolic demand
3. Maintenance of good litter conditions

The maximum level of CO₂ allowed at any time in the chicken house is 3,000 ppm. If the house environment exceeds 3,000 ppm of CO₂ or less than 19.6 % O₂ then the ventilation rate must be increased.

Air quality guidelines	
Oxygen	> 19.6 %
Ammonia	< 10 ppm
Respirable Dust	< 3.4 mg/m ³
Relative Humidity	< 65 %
Carbon Monoxide	< 10 ppm
Carbon Dioxide (CO ₂)	< 0.3 % / 3,000 ppm
Air exchange (with minimal air movement at chick level)	<0.30 m/s (60 fpm)



Animal Welfare Tips

With increased CO₂ levels (> 3,000 ppm), bird behavior and activity will be reduced. If not corrected, this reduced activity level can negatively impact bird growth and feed consumption. Always evaluate flock behavior and adjust the ventilation system to provide the birds with good quality air.

5-minute timer cycle to control minimum ventilation

- ✓ The timer fan capacity should be a minimum of 0.3 m³/min per m² (1.0 cfm per ft²) in hot climates where outside temperatures rarely drop below 20 to 25 °C (68 to 77 °F). In cold climates a timer fan capacity of 0.61 to 0.77 m³/min per m² (2 to 2.5 cfm/ft²) of floor area, will be needed.
- ✓ Always match fan capacity as close to requirement as possible.
- ✓ At placement, fans should be cycled for approximately 45 to 60 seconds to ensure adequate mixing of cold incoming and warm internal air (see table right).
- ✓ A 5-minute (300-second) ON/OFF cycle is preferred for minimum ventilation. The cycle should never exceed 10 minutes.
- ✓ Any time the air quality begins to deteriorate, the ON time must be increased - but the total cycle time always remains constant.
- ✓ Humidity should be maintained below 60 to 65 % where possible.
- ✓ Increases in ON times should be made in small increments – 10 to 15 seconds and monitored for 24 hours.
- ✓ Correct operation of the perimeter inlets is vital in achieving good air distribution and moisture control.

Minimum ventilation timer settings (5 min (300 sec) timer)		
Day	ON (seconds)	OFF (seconds)
1	45 to 60 (20 %)	240
3	45 to 60	240
5	75	225
8	90	210
11	105	195
14	120	180
18	135	165
22	150	150
25	165	135
30	180 (60 %)	120



Animal Welfare Tips

If the flock is inactive, appears uncomfortable, or noisy due to thermal stress, consider increasing the time "ON" for the cycle timer so that air exchanges are increased. Increasing the fresh air and improving the air quality in the bird space can result in more active, uniformly distributed, and comfortable birds.

9.2 Fans Required for Minimum Ventilation

The minimum ventilation system must have sufficient capacity to operate for the full life of the flock. The following is an example calculation of the number of fans required. **The minimum ventilation calculations are only guidelines.** Daily adjustments should be made based on air quality and humidity. The range and capacity of fans used for cycle ventilation will increase over time until all installed minimum ventilation fans are used.

Calculations for the number of fans required for minimum ventilation in a standard tunnel ventilated house

Sample fans

- ✓ Fans capacities used in the examples are rated at 25 pa (0.1 in wc)
- ✓ Exhaust or side wall fans: 900 mm (36 in), working capacity of 340 m³/min (12,000 cfm).
- ✓ Air exchange range: 0.3 to 0.6 m³/min per m² of floor area (1 to 2 cfm per ft² of floor area).

Notes: These fans can be fixed volume or variable speed.

The 0.61 m³/min per m² (2 cfm per ft²) of floor area fan capacity is only needed in cold climates.

Sample house dimensions

House dimensions: 150 m long, 14 m wide and 2.88 m average height

House dimensions: 500 ft long, 46 ft wide and 9.25 ft average height

Average height = 2.5 m + (0.5 x 0.75 m) = 2.88 m

Average height = 8 ft + (0.5 x 2.5 ft) = 9.25 ft

House floor area: 150 m x 14 m = 2,100 m²

House floor area: 500 ft x 46 ft = 23,000 ft²

$(\text{House floor area} \times \text{Air exchange rate}) \div \text{Working capacity} = \text{Number of fans required}$

2,100 m² x 0.3 to 0.6 m³/min per m² of floor area = 630 to 1260 m³/min
 630 to 1260 m³/min ÷ 340 m³/min = 1.85 to 3.70 or **2 to 4 fans**

23,000 ft² x 1 to 2 cfm per ft² of floor area = 23,000 cfm to 46,000 cfm
 23,000 cfm to 46,000 cfm ÷ 12,000 cfm = 1.91 to 3.83 or **2 to 4 fans**

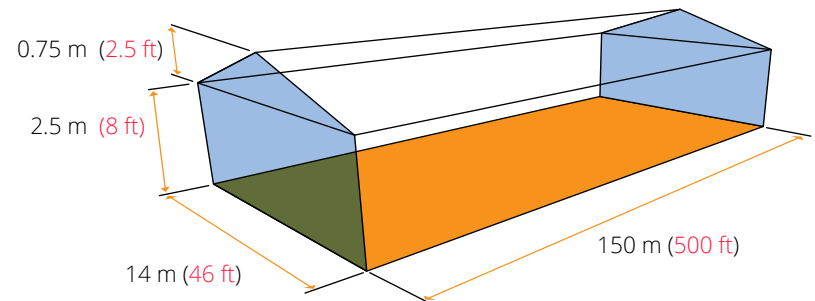

9.3 Negative Pressure - Key Requirement for Minimum Ventilation

Using a negative pressure ventilation system is the most efficient way to accomplish air distribution for minimum ventilation. The pressure drop across the inlets and amount the inlet is opened should be adjusted to ensure that the incoming air jet attaches to the ceiling and starts to detach just before reaching the peak of the house where the heat has accumulated.

The table (right) can be used as a reference guide to determine the required inlet pressure drop. The pressure drop selected will depend on the house width, how far the incoming air jet must travel once it enters the house, and the outside temperature. When outside temperatures are below 5 °C (40 °F) the inlet pressure drop and opening size must be increased. The ability of the incoming air jet to attach to the ceiling depends on the temperature differentials between outside and inside the house. Always use a smoke test to ensure that the incoming air reaches the center of the house. Smoke tests should only be done when the outside temperatures are significantly colder than inside, and when there is no wind.

Houses with obstructions such as purlins or electrical conduit can interrupt the incoming air jet. Houses need to have smooth solid ramps installed about 3 m (9.8 ft) in front of the perimeter inlets. See section 8.3 for more information.

Note: In houses with side wall (perimeter) inlets that are positioned lower on the wall, the pressures and inlet openings need to be increased accordingly to ensure the incoming air jet reaches into the center of the house. This is especially important with low outside temperatures.

Required inlet airspeed and pressure difference							
House width m	ft	Pascals (Pa)	Inches of water (in wc)	Airspeed		Distance air travels	
				m/s	fpm	m	ft
10	30	20	0.08	5.7	1,112	5.0	16
12	40	25	0.10	6.5	1,280	6.0	20
15	50	31	0.12	7.2	1,417	7.5	25
18	60	37	0.15	7.8	1,535	9.0	30
21	70	43	0.17	8.4	1,654	10.5	35
24	80	49	0.20	9.0	1,772	12.0	40

Guideline: For every 61 cm (2 ft) the incoming air needs to travel, a pressure drop of 2.5 Pa (0.01 in wc) is required. This will need to be significantly increased when outside temperatures drop below 5 °C (40 °F).

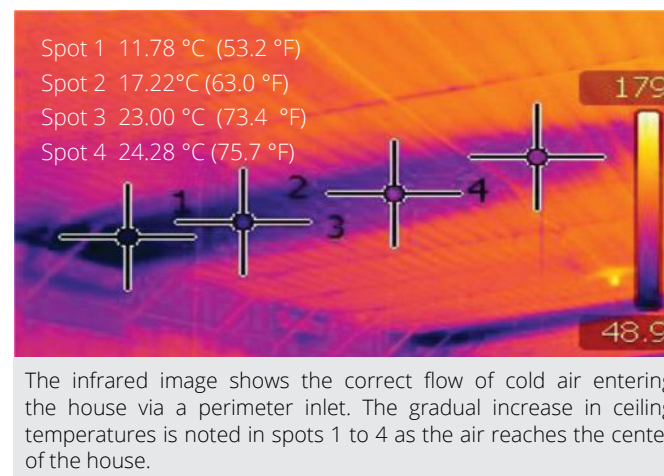

Animal Welfare Tips

In addition to daily temperature monitoring, evaluate bird behavior, activity and distribution within the house. If birds are hot or chilled, they will behave differently than birds that are comfortable. For example, if cool air enters via inlets, does not mix at the ceiling and drops directly to the floor, birds will preferentially move away from this cooler area and may huddle or congregate in a more central location in the house.

9.4 Perimeter Inlet Management

Perimeter inlets are an most important part of the house ventilation system. Positioning and design of the inlets will significantly impact the direction of the incoming cold air. During cool seasons, fresh air (cooler and heavier) that enters the house mixes with warm, dry air before reaching the birds. While mixing, the temperature of the incoming air increases and humidity decreases. The perimeter inlets are one tool that can condition the incoming air. With these, the airflow can be directed in a way that allows the air to gain heat and decrease humidity as it flows into the center of the house. **For every 11 °C (20 °F) increase in temperature the relative humidity will be halved.**

The most common consequence of poorly managed inlets is the litter humidification and compaction, primarily along a side wall due to cold drafts. A well-designed inlet should close and seal completely when the fans are off. When open, the air should only enter over the top of the inlet and not from the sides or the base of the inlet. Inlets that leak air through the sides and base will direct cold air to the floor, causing chilled birds and condensation.

Inlet openings should be pressure controlled to maintain a constant airflow at different fan capacities. When cables are being used to operate the inlets, special attention needs to be given to the nylon cords which are closing the inlets. Cables can stretch and are prone to cause uneven openings. Inlets that do not close completely will cause heat and energy losses, especially under windy conditions. A 5 to 8 mm (0.2 to 0.3 in) steel rod is the preferred material to be used when installing the inlets.

The inlets used for minimum ventilation need to open enough to achieve the required static pressure and air jet. Depending on the inlet design, a minimum opening of 2.5 cm to 5 cm (1 to 2 in) is required to ensure cold incoming air jets attach to the ceiling and detach near the center. Always smoke test the house in cold weather or attach a series of ribbon tapes to the ceiling from in front of the inlet to the center of the house. Place these ribbons at an inlet close to the control room for easy observation.

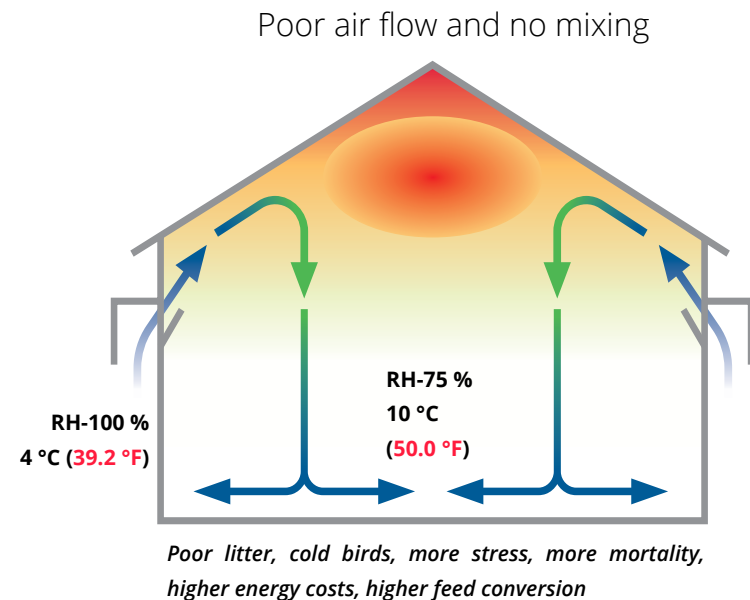
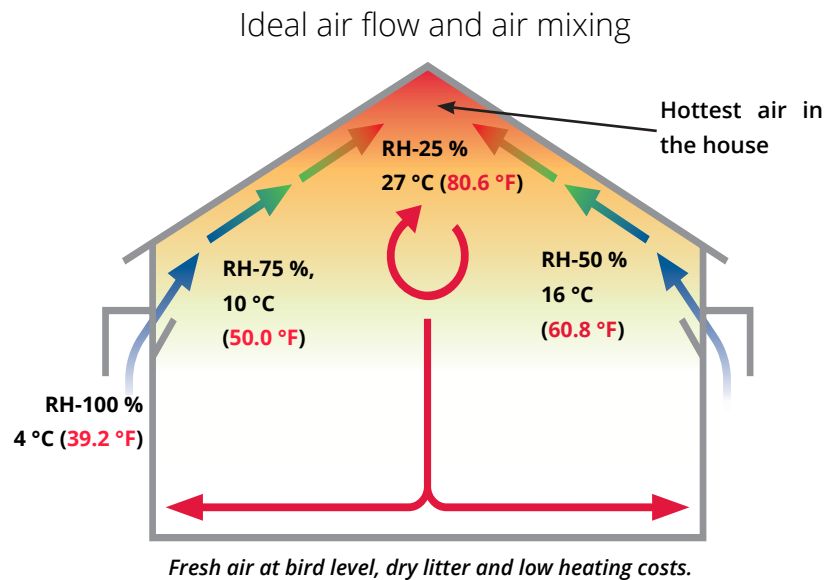

9.5 Simple Negative Pressure Test

To effectively generate a negative pressure system in a broiler house, the house must be as airtight as possible. Typically, leaks are located along the roof ridge, close to the fan shutters, around doors and along stem walls. In curtain sided broiler houses, the curtains are usually the largest source of leaks.

Test how well the house is sealed by closing all the inlets, then measure the pressure drop across any inlet or door. Turn on the equivalent of 0.30 m³/min (1 cfm per ft²) of fan capacity per m² of floor area. A pressure above 37.5 Pa (0.15 in wc) should be recorded across the opening. Pressures below 25 Pa (0.10 in wc), indicates the house is poorly sealed.

9.6 Transition Ventilation

Transition ventilation begins to operate when the house thermostat overrides the cycle timer allowing the cycle fans to run continuously and the remaining transition fans to stage for temperature control. Transition ventilation is the temperature control stage between the minimum ventilation stage and tunnel ventilation. The key function of transition ventilation is to increase house air exchange and manage temperature without creating high airspeeds or velocity at bird level. The maximum airspeeds, generated in full transition mode, can range from 25 to 50 % of full tunnel ventilation capacity in modern tunnel ventilated houses. It is a vital stage of ventilation in tunnel ventilated houses to ensure bird comfort and early feed intake. Flock uniformity always starts in the first week and is driven by early feed intake and temperature management.

Fan capacity requirement for full transition

In a standard tunnel ventilated broiler house, the transitional ventilation system typically uses 50 % of the total tunnel ventilation capacity. In colder climates, having more transition capacity is beneficial. The capacity can also be expressed in terms of floor area: 1.7 to 1.85 m³/min per m² of floor area (5.5 to 6 cfm per ft² of floor area) or air exchange rates of 2 to 3 minutes when in full transition.

- ✓ These fans use perimeter wall inlets that are evenly distributed lengthwise down the house. The inlets are most efficient when controlled by negative pressure. This system gives excellent temperature control, reduces the risk of chilling the birds, and is a valuable part of any ventilation system.
- ✓ During the final stage of transition ventilation (full transition), the inlets are fully opened and the tunnel inlet will open to provide additional incoming air to match the fan requirement and balance the static pressure.

How many inlets for full transition?

- ✓ Depends on - capacity of a single inlet at a specific static pressure.
- ✓ Depends on - the air exchange requirement in full transition mode.
- ✓ In cold climates, houses that do not have a tunnel ventilation system will use perimeter wall inlets for all levels of ventilation. These houses should have a maximum air exchange capacity of less than 1 minute to cope with hot conditions.
- ✓ Tunnel ventilation can be delayed by operating more fans through both the perimeter wall and tunnel inlets. These further stages, sometimes referred to as tunnel assist mode, allow significant increases in air exchange without dramatic increases in airspeeds at floor level.
- ✓ When house temperatures are 2 to 3.5 °C (3 to 5 °F) above target temperatures, the house will transition to tunnel ventilation.

Calculating transition ventilation inlet capacity

Sample fans

Fan capacities used in the examples are rated at 25 Pa (0.1 in wc)
 900 mm (36 in wc), working capacity of 340 m³/min (12,000 cfm)
 1,270 mm (50 in wc), working capacity of 680 m³/min (24,000 cfm)
 Fan requirement based on house floor area: 1.7 to 1.85 m³/min per m² of floor area
 (5.5 to 6 cfm per ft² of floor area)

Sample house dimensions

House dimensions: 150 m long, 14 m wide and 2.88 m average height
 House dimensions: 500 ft long, 46 ft wide and 9.25 ft average height
 Average height = 2.5 m + (0.5 x 0.75 m) = 2.88 m
 Average height = 8 ft + (0.5 x 2.5 ft) = 9.25 ft
 House floor area: 150 m x 14 m = 2,100 m²
 House floor area: 500 ft x 46 ft = 23,000 ft²

Example calculation of how many fans needed using fan capacity of 680 m³/min (24,000 cfm)

Floor area x 1.7 to 1.85 m³/min per m² (5.5 to 6 cfm per ft²) = number of fans needed
 2,100 m² x 1.7 to 1.85 m³/min = 3,570 to 3,885 m³/min = **5 to 6 fans needed**
 23,000 ft² x 5.5 to 6 cfm per ft² = 126,500 to 138,000 cfm = **5 to 6 fans needed**

Example calculations of how many inlets are needed using an inlet with a capacity of 34.5 m³/min (1,218 cfm) at 25 Pa

**Note: If inlet capacity is unknown and a basic rectangular surface mounted unit, use the following assumptions:
 Standard Inlet capacity = 7229 m³/min per m² (750 cfm per ft²) of inlet opening at 25 Pa (0.10 in wc).**

Step 1: Total Transition Fan Capacity = Number of fans needed X Fan capacity

6 x 680 m³/min (24,000 cfm) = **4,080 m³/min or 144,000 cfm**

Step 2: Number of inlets = Total Transition Fan Capacity ÷ Inlet Capacity

4,080 m³/min (144,000 cfm) ÷ 34.5 m³/min (1,218 cfm) =

118 inlets or 59 inlets per side (common practice to add extra 10 % inlet capacity).



9.7 Tunnel Ventilation

Tunnel ventilation is used in hot weather for cooling. The tunnel ventilation fans are placed at one end of the house and air intake at the opposite end. The air flow creates a wind-chill effect, which produces the effective temperature experienced by the bird. The effective temperature experienced will depend on airspeed, bird age, relative humidity and other factors and can range from 1 to 8 °C (1 to 12 °F) below ambient temperatures. The temperature differential between the front and the end of the house will depend also on house length. Bird effective temperatures should be maintained below 30 °C (86 °F).

Age (days)	Max Airspeed (m/s)	Max Airspeed (fpm)
0 to 5	0 to 0.3	0 to 60
5 to 14	0.3 to 0.5	60 to 100
14 to 21	0.5 to 1.8	100 to 350

To ensure maximum bird activity and feed intake, during brooding and the first 25 days, keep airspeeds within the limits given in the table above, unless air temperatures are above target temperatures for specific ages. It is possible to use some air speed on chicks during the first 14 days, when the ambient temperature is very close to their body temperatures.

Tunnel fan capacity or air exchange rate should be sufficient to ensure a maximum temperature differential (ΔT) of 2.8 °C (5 °F) from the front to the end of the house on the hottest day with market age birds at maximum stocking density.

Wind Chill Effects for 28 and 42 day old broilers at dry bulb of 29.5 °C

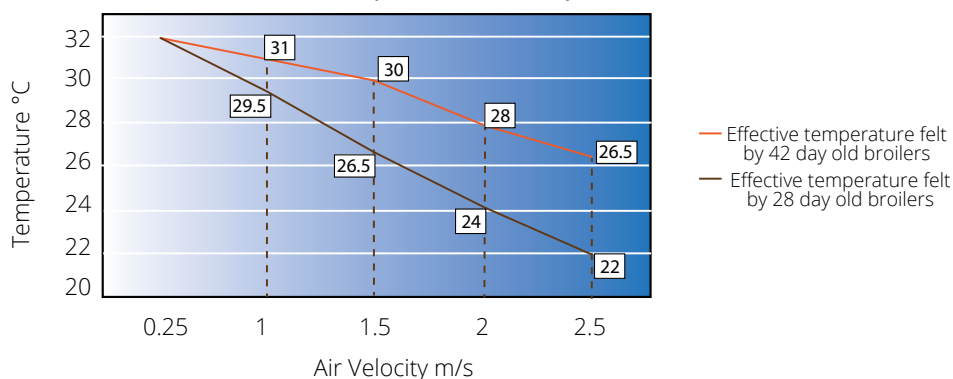

Wind Chill Effects for 28 and 42 day old broilers at dry bulb of 85 °F

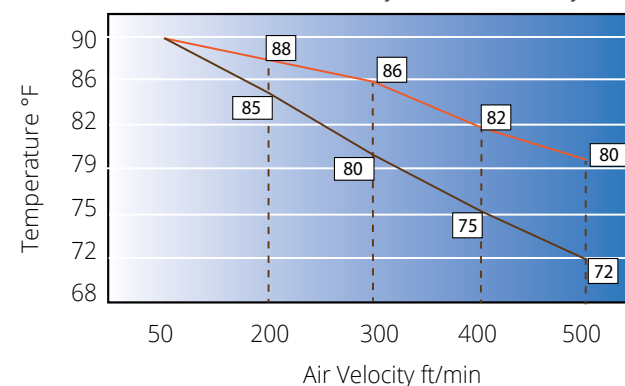

Animal Welfare Tips

Chicks do not have the ability to regulate body temperature for the first 5 days and thermoregulation is not fully developed until 14 days of age. If birds are chilled at an early age due to high air speed from the tunnel ventilation system, broilers will reduce their activity (less eating, drinking and moving) to conserve energy and their body temperature).

Understanding negative pressure measurements in full tunnel mode

The pressure readings will increase from the front to the extraction end of the house. The pressure reading at the extraction end is an indication of the amount of work the fans must do to move the air down the length of the house. It is a sum of the following pressure drops: 1) pad pressure, 2) tunnel inlet curtain or door pressure drop, (in most cases this will be very small) 3) transition or “squeeze” pressure, (the pressure drop caused by the slower incoming air moving from the relatively large tunnel inlets and then being forced to turn 90 degrees into a much smaller house cross section with almost a doubling in speed) and 4) pipe pressure, which includes resistance created by objects such as feed hoppers. The transition pressure will depend on tunnel air velocity, the higher the velocity the greater the transition pressure drop. Pipe pressure will depend on house length and the presence of equipment and restrictions.

Estimated fan operating pressure in a 3 m/s (600 fpm) broiler house with evaporative cooling

$$\begin{aligned} &\text{Pad pressure} + \text{Tunnel Door} + \text{Transition} + \text{Pipe pressure} \\ &= 12.5 \text{ Pa} + 2.5 \text{ Pa} + 10 \text{ Pa} + 10 \text{ Pa} = \mathbf{35 \text{ Pa}} \\ &= 0.05 \text{ in wc} + 0.01 \text{ in wc} + 0.04 \text{ in wc} + 0.04 \text{ in wc} = \mathbf{0.14 \text{ in wc}} \end{aligned}$$

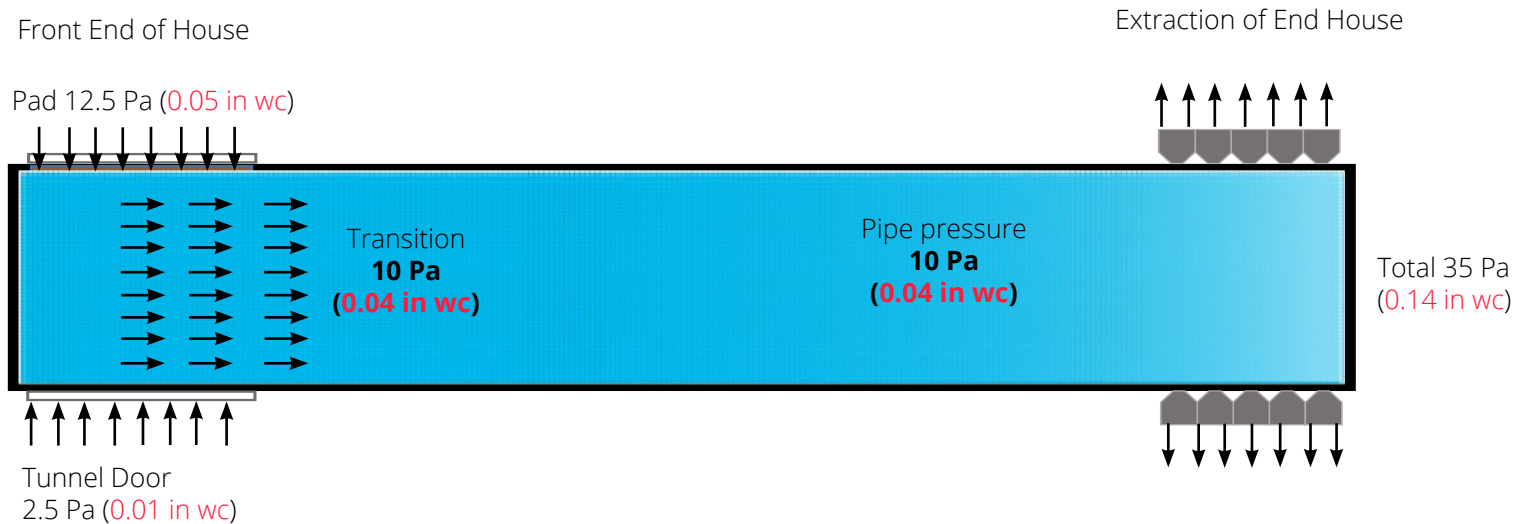

Key points when choosing or comparing tunnel fans

- ✓ High capacity cone fans with diameters ranging from 127 cm (50 in) to 145 cm (57 in) are the most suitable for a tunnel ventilation system.
- ✓ When comparing fans for use in tunnel ventilation, it is always best to use their operating capacities at 25 Pa (0.10 in wc) or more.
- ✓ Energy efficiency should be more than 0.0109 m³/s (23 cfm) per Watt.
- ✓ Air flow ratio should be a minimum of 0.75. The "Airflow Ratio" is the ratio of a fan's airflow at 50 Pa (0.2 in wc) divided by airflow at 12.5 Pa (0.05 in wc) or the capacity lost over these pressure ranges.
- ✓ Fans shutters should be well sealed to prevent air leaks, and always mounted on the inside of the fan.
- ✓ Fans should be purchased on efficiency, build quality, reliability and life span, not only price.



Adjusting tunnel inlet for correct air distribution

The diagrams (below) illustrate the importance of maintaining the correct airspeed and negative pressure drop at the tunnel inlet curtain or door. Very low inlet airspeeds and pressure drops will cause "dead spots" (usually by the front wall and the first section of side walls after the tunnel inlet opening). The tunnel inlet door or curtain pressure drop must be adjusted to help reduce dead spots. If air speeds are not improved, temperatures will be higher in these areas and the flock could become heat stressed. Tunnel doors have the advantage over tunnel inlet curtains in that they improve air movement in the tunnel inlet area reducing dead spots near the side walls just past the tunnel inlet opening. This improves the airspeed uniformity over the cross section of the house. (See the images).

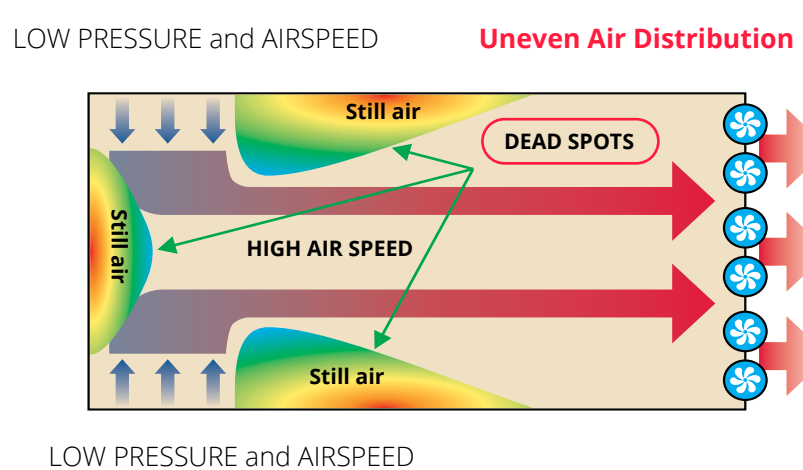
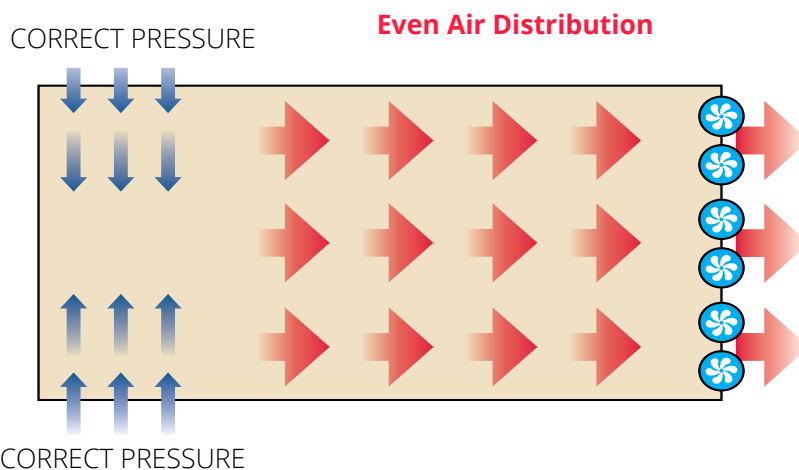

Calculations for tunnel ventilation rates

General tunnel fan requirements for a well-insulated and sealed tunnel house

Broilers

9 to 11 cfm per ft²

2.75 to 3.35 m³/min per m²

(165 to 200 m³/h per m²)

Sample house dimensions

House dimensions: 150 m long, 14 m wide and 2.88 m average height

House dimensions: 500 ft long, 46 ft wide and 9.25 ft average height

Cross section: 14 m wide x 2.88 m average height = 40.32 m²

Cross section: 46 ft wide x 9.25 ft average height = 425.5 ft²

House volume: 150 m long x 14 m wide x 2.88 m average height = 6048 m³

House volume: 500 ft long x 46 ft wide x 9.25 ft average height = 212,750 ft³

Sample fans

Example for production house: 3 m/s (600 fpm)

Fans capacities used in the examples are rated at 25 Pa (0.1 in wc).

1,270 mm (50 in wc), working capacity of 680 m³/min, 11.3 m³/s, (24,000 cfm).

Step 1: Fan capacity required to achieve an airspeed of 3.0 m/s (600 fpm) at 25 Pa (0.10 in wc)

Required fan capacity = Cross section x Airspeed

40.32 m² x 3.0 m/s = **120.96 m³/s or 7,257 m³/min**

425.5 ft² x 600 fpm = **255,300 cfm**

Number of 1.27 m (50 in) fans required:

7,257 m³/min ÷ 680 m³/min = 10.67 or **11 fans**

255,300 cfm ÷ 24,000 cfm = 10.63 or **11 fans**

Step 2: House air exchange should be between 40 and 50 seconds

Air Exchange = House Volume ÷ Total Fan Capacity

6,048 m³ ÷ (11 x 680 m³/min) = 6,048 m³ ÷ 7,480 m³/min = 0.80 min or **49 seconds**

212,750 ft³ ÷ (11 x 24,000 cfm) = 212,750 cfm ÷ 264,000 cfm = 0.80 min or **49 seconds**

Step 3: Is the airspeed adequate?

Airspeed = Total Fan Capacity (m³/min) ÷ Cross Section Area (m²)

(11 x 11.3 m³/s) ÷ 40.32 m² = **3 m/s**

(11 x 24,000 ft³/min) ÷ 425 ft² = **620 fpm**

9.8 Evaporative Cooling

The primary role of the evaporative cooling system is to maintain house temperature below 28.0 °C (82.4 °F). For every 1 °C produced by the evaporative cooling system, the percent relative humidity of the air will increase approximately 4.5 %. (1 °F = 2.5 % RH increase).

Evaporative pad management

- ✓ All tunnel fans should be activated before operating cooling pads!
- ✓ Do not use pads should at temperatures below 28 to 29 °C (82 to 84 °F). Excessive use of evaporative cooling will affect litter moisture.
- ✓ House humidity should not exceed 85 %.
- ✓ Do not use fogging in conjunction with pads if relative humidity is above 75 %.
- ✓ Generally, pads are used from 9 AM to 6 PM due to daily humidity cycles – Nighttime operation will increase heat stress.
- ✓ Pad system should be flushed weekly.
- ✓ Monitor water quality and pH. Maintain hardness levels below 110 ppm and pH in the sump between 7 and 9. Bleed off the system continuously following the manufacturers recommendations. High levels of salts and minerals will require more frequent bleed-off.
- ✓ Do not run the evaporative cooling pumps on a cycle timer. The frequent drying of the evaporative pads will cause buildup of mineral and scale on the outside surface, especially on farms with high levels of salts and minerals in the water supply.
- ✓ Do not use evaporative cooling before 25 days of age. Only during extremely high temperatures, should pads be used with chicks in the first two weeks. Wetting of the pads must be limited with an interval timer. Pads are used only to temper the incoming air.
- ✓ For cleaning, algae control, descaling, and disinfection only use products recommended by the manufacturer - refer to the manufacturer's guidelines.
- ✓ DO NOT ADD CHLORINE.

Common ventilation causes of wet litter and high humidity

- ✓ High stocking densities due to bird migration – too many birds in the cool pad area.
- ✓ The evaporative (cool cell) pumps running excessively with low air exchange rates – all tunnel fans should be on.
- ✓ Running the evaporative (cool cell) pumps when dry bulb temperature is below 28.0 °C (82.4 °F).
- ✓ Running the evaporative (cool cell) pumps when relative humidity outside the house is above 75 %.



Evaporative pad cooling potential (°C)

The table is an example of the cooling potential of an evaporative cooling system with a 75 % efficiency rating. It illustrates the cooling potential through evaporation over a wide range of outside relative humidity and dry bulb temperatures. In the table (right), the colored cells indicate cooling potential as follows:

- Blue - acceptable cooling
- Yellow - marginal cooling
- Red - insufficient cooling

For every 1 °C of cooling produced by the evaporative cooling system, the % RH of the air will increase approximately 4.5 % (1 °F = 2.5 % RH increase). The two scenarios (A and B) both with outside dry bulb temperatures of 32 °C, but with two relative humidity levels: 30 and 60 % respectively.

COBB BROILER MANAGEMENT GUIDE

A.

32 °C and 30 % RH:

Potential reduction in house temperature is 9 °C

Added humidity: $4.5 \% \times 9\text{ °C} = 40.5 \%$

New combined humidity inside the house: 30% (outside) + 41 % = 71 %

B.

32 °C and 60 % RH:

Potential reduction in house temperature is 5 °C

Added humidity: $4.5 \% \times 5\text{ °C} = 23 \%$

New combined humidity inside the house: 60 % (outside) + 23 % = 83 %

Outside % RH	27	28	29	30	31	32	33	34	36	37	38	39	40
100	27	28	29	30	31	32	33	34	36	37	38	39	40
95	26	27	28	29	31	32	33	34	35	36	37	38	39
90	26	27	28	29	30	31	32	33	34	36	37	38	39
85	25	26	27	28	29	31	32	33	34	35	36	37	38
80	24	26	27	28	29	30	31	32	33	34	35	36	37
75	24	25	26	27	28	29	31	31	32	33	34	36	37
70	23	24	26	27	28	29	29	31	32	33	34	35	36
65	23	24	25	26	27	28	29	30	31	32	33	34	35
60	22	23	24	26	26	27	28	29	31	31	32	33	34
55	22	23	24	24	26	27	28	28	29	31	32	33	33
50	21	22	23	24	25	26	27	28	29	30	31	32	33
45	21	21	22	23	24	25	26	27	28	29	30	31	32
40	20	21	22	23	23	24	26	26	27	28	29	30	31
35	19	20	21	22	23	24	24	26	27	27	28	29	30
30	18	19	20	21	22	23	24	25	26	27	27	28	29
25	18	18	19	21	21	22	23	24	25	26	27	27	28
20	17	18	19	19	21	21	22	23	24	25	26	27	27
15	16	17	18	19	19	21	21	22	23	24	24	26	27
10	16	16	17	18	19	19	21	21	22	23	24	24	26
5	14	16	16	17	18	19	19	21	21	22	23	23	24
0	14	14	16	16	17	18	19	19	20	21	22	23	23
	27	28	29	30	31	32	33	34	36	37	38	39	40

Evaporative pad cooling potential (°F)

The table is an example of the cooling potential of an evaporative cooling system with a 75 % efficiency rating. It illustrates the cooling potential through evaporation over a wide range of outside relative humidity and dry bulb temperatures. In the table (right), the colored cells indicate cooling potential as follows:

Blue - acceptable cooling

Yellow - marginal cooling

Red - insufficient cooling

For every 1 °C of cooling produced by the evaporative cooling system, the % RH of the air will increase approximately 4.5 % (1 °F = 2.5 % RH increase). The two scenarios (A and B) both with outside dry bulb temperatures of 32 °C, but with two relative humidity levels: 30 and 60 % respectively.

A.

90 °F and 30 % RH:

Potential reduction in house temperature is 17 °F

Added humidity: 2.5 % × 17 °C = 42.5 %

New humidity inside the house: 30% (outside) + 42.5 % = 72.5 %

B.

90 °C and 60 % RH:

Potential reduction in house temperature is 9 °F

Added humidity: 2.5 % × 9 °F = 22.5 %

New humidity inside the house: 60 % (outside) + 22.5 % = 82.5 %

Outside % RH	Expected Cooling Produced by 15 cm (6 in) Pad System													
	80	82	84	86	88	90	92	94	96	98	100	102	104	
100	80	82	84	86	88	90	92	94	96	98	100	102	104	
95	79	81	83	85	87	89	91	93	95	97	99	101	103	
90	78	80	82	84	86	88	90	92	94	96	98	100	102	
85	77	79	81	83	85	87	89	91	93	95	97	98	100	
80	76	78	80	82	84	86	88	90	91	93	95	97	99	
75	75	77	79	81	83	85	87	88	90	92	94	96	98	
70	74	76	78	80	82	84	85	87	89	91	93	95	96	
65	73	75	77	79	80	82	84	86	88	90	91	93	95	
60	72	74	76	78	79	81	83	85	87	88	90	92	94	
55	71	73	75	76	78	80	82	83	85	87	89	91	92	
50	70	72	73	75	77	79	80	82	84	86	87	89	91	
45	69	70	72	74	76	77	79	81	83	84	86	88	89	
40	68	69	71	73	74	76	78	79	81	83	84	86	88	
35	66	68	70	71	73	75	76	78	80	81	83	85	86	
30	65	67	68	70	72	73	75	77	78	80	81	83	85	
25	64	65	67	69	70	72	73	75	77	78	80	81	83	
20	63	64	66	67	69	70	72	74	75	77	78	80	81	
15	61	63	64	66	67	69	70	72	73	75	76	78	80	
10	60	61	63	64	66	67	69	70	72	73	75	76	78	
5	58	60	61	63	64	66	67	69	70	72	73	74	76	
0	57	58	60	61	63	64	66	67	68	70	71	73	74	
	80	82	84	86	88	90	92	94	96	98	100	102	104	

9.9 Natural Ventilation

Natural ventilation is the supply of fresh air through natural forces. It is common in temperate regions where the climate is similar to the desired production environment and where access to electricity is limited. This system is not recommended in regions with wide seasonal differences. There are two types of natural ventilation: thermal buoyancy ventilation and wind-driven ventilation.

Thermal buoyancy ventilation occurs naturally when there is no wind and is the preferred method for cold weather or during brooding, because air is exchanged slowly. Wind-driven ventilation is not ideal for cold weather, but can be used in hot weather because the high air exchange rates facilitate the removal of metabolic heat and provide some wind chill effect.

- ✓ Ventilation at all ages of birds is needed to remove excess heat, humidity, ammonia and CO₂. CO₂ is a risk factor in the first week when the house is well sealed. The level of CO₂ should never exceed 3,000 ppm. (See air quality guidelines section 9.1)
- ✓ Good curtain management is vital to prevent respiratory challenges and ascites that may result from cold conditions.
- ✓ Minimize temperature fluctuations, especially at night. Better temperature control will improve bird comfort, feed conversion and improve growth rate.
- ✓ A reflective roof surface with a minimum insulation R-value of 10 to 20 and a 1.5 m (5 ft) roof overhang must be considered.
- ✓ Successful natural ventilation depends on house location. Houses should be built in an east to west orientation to reduce solar heating of the sidewalls during the hottest part of the day.
- ✓ Ideally the house should be oriented perpendicular to the prevailing summer wind. Consider the wind direction in the morning and open the curtain on the leeward (non-windy) side first.
- ✓ Planting trees or using shade materials on the north or south side of the house will help reduce solar heating. However, structures or vegetation must not restrict wind movement. Prevailing winds should be used advantageously.

Management Techniques for Naturally Ventilated Houses without Wind

Thermal buoyancy ventilation works because hot air rises. The flock and heating system in a naturally ventilated barn heat the air, the hot air rises and is released through a ridge vent. The size of the ridge vent opening and distance between the inlets and outlet will determine the rate of air exchange. The larger the openings or the greater the distance from inlet to the outlet in the ridge, the greater the air exchange. In houses without a ridge opening, creating an air exchange without wind or outside air movement will be very difficult as the curtain opening has to function as both an inlet and outlet.

Because natural ventilation is very reliant on the weather, it can be challenging to manage air exchange rates. Thermal buoyancy requires a significant temperature difference between the inside and outside of the house. However, if the incoming air temperature drops below 5 °C it is nearly impossible to get any significant mixing of the cold incoming air and the warm air in the peak of the house.

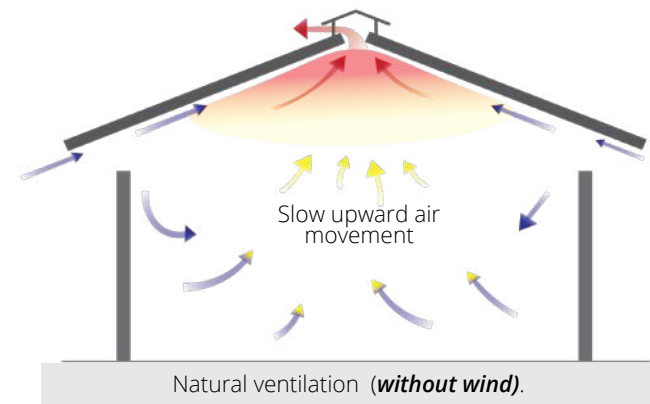

Management Techniques for Naturally Ventilated Houses with Wind

During brooding and cold weather, wind is a major concern because it can easily increase ventilation. Wind-driven ventilation occurs when wind enters through the open curtain on the windward side of the house. Wind speed and angle as well as the windward and leeward curtain opening amount affect the amount of ventilation.

- ✓ Wind-driven ventilation will increase as the curtain opening on the windward side is increased. An opening ratio of 1 to 2 or, 1 to 3 is ideal, but will depend on local conditions, house design and whether a ridge outlet is installed.
- ✓ Consider the wind direction in the morning and open the curtain on the leeward (non-windy) side first. To facilitate air exchange and ensure incoming cold air is not directed to floor level, the curtain opening on the leeward side is always open more than the windward side.
- ✓ Until 14 days of age, the curtains should be opened minimally to provide sufficient air exchange in the house but no air speed at chick or floor level. Air speed across the chicks in the first fourteen days of age leads to chilling, decreased feed and water consumption and increased energy use for heat production.

In hot weather, to achieve maximum air speed (air exchange) across the birds, the curtain should be opened the same amount on both sides and as low as possible, taking full advantage of the wind.

- ✓ During hot weather walk through the flock slowly and regularly to encourage air circulation around the birds and stimulate water consumption.
- ✓ Remove feed from the flock by lifting the feeding system six hours before the hottest part of the day. This reduces the body heat output due to feed metabolism. Feed can be returned to bird level in the early evening hours when the outside temperature is cooler.
- ✓ In a well-sealed house, wind produces pressure. The higher the wind speed, the greater the pressure drop produced. Some approximations of expected pressure drops:

8 km/h = 15 Pa	5.0 mi/h = 0.06 in wc
15 km/h = 25 Pa	9.3 mi/h = 0.10 in wc
25 km/h = 27 Pa	15.5 mi/h = 0.11 in wc

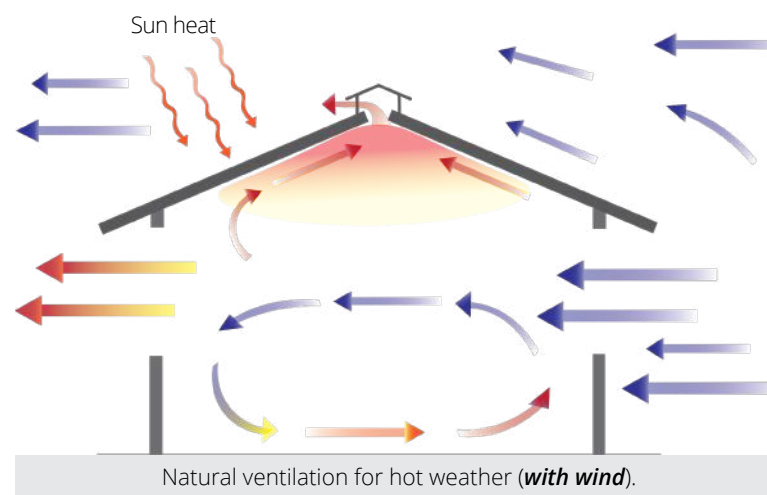
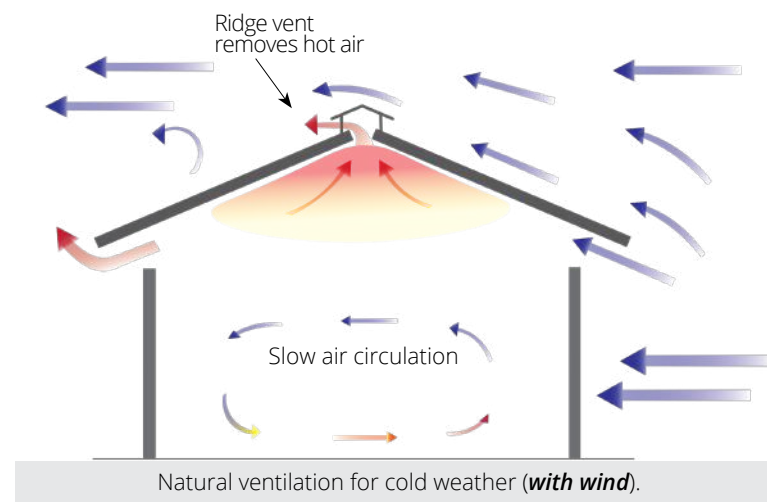

Key Points When Installing Stirring Fans in a Naturally Ventilated House

- ✓ Minimum size: not less than 900 mm (36 in) direct drive fans with an operating capacity of 5.75 m³/s or 345 m³/min (10,500 cfm) at 50 Pa.
- ✓ A 900 mm (36 in) fan will only draw air from 1 m (3.3 ft) and move air 12 m (40 ft). Maximum dispersion that a 900 mm fan will distribute air is 2.2 m (7.2 ft).
- ✓ Fans should be suspended perpendicular to the floor and 1 m (3.3 ft) above the floor.

Temperature Recommendations for Stir Fan and Fogger Operation

- ✓ Do not use cooling fans in the first 14 days!
- ✓ Fans divided into two groups
- ✓ Group 1 (red fans in model) on 2 °C above set point
- ✓ Group 2 (green fans in model) on 4 °C above set point
- ✓ Foggers on 6 °C above set point

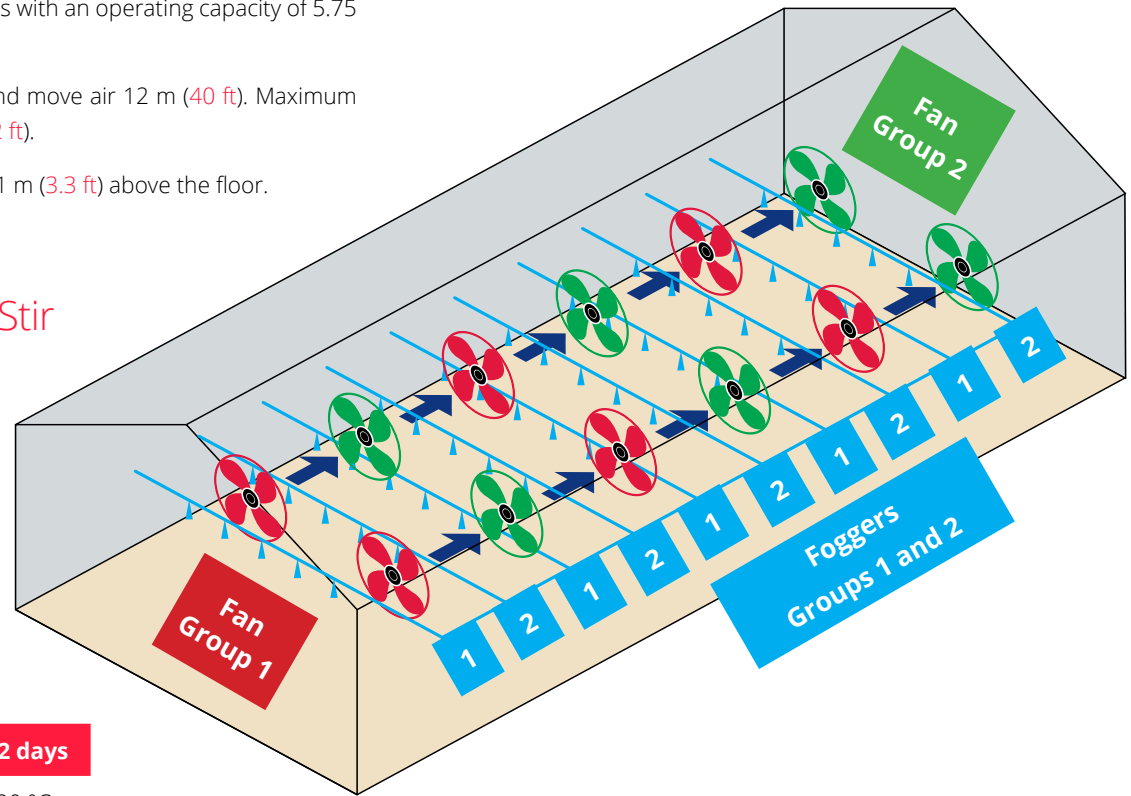

	28 days	35 days	42 days
Fan Line Group 1	25 °C	22 °C	20 °C
Fan Line Group 2	27° C	24 °C	22 °C
Fogger Line Group 1	30 °C	27 °C	27 °C
Fogger Line Group 2	32 °C	29 °C	29 °C



Animal Welfare Tips

In naturally ventilated houses with fans suspended, safety for the birds and human caretakers is very important. Fans should have wire guards on both sides to prevent contact with the fan blades and prevent bird and human injury. Fans should be securely suspended at least 1 m (3.3 ft) above the floor.

10

Catching Procedures

Logistics

The goal of the planning and coordination of the catching process is to ensure minimal carcass shrinking and high animal welfare standards. This is a complex process that will require the coordination of farm starting times, multiple catching crews and processing plant schedules.

The catching process requires good communication and planning that must include the following key areas:

- ✓ Plant processing schedule: Check that birds are available to process with minimal holding time.
- ✓ Transportation and driving distance from farm to plant: Coordinate transportation and calculate driving distance into feed withdrawal times.
- ✓ Catching crew schedule: Ensure that crews are scheduled to catch the birds.
- ✓ Farm logistics: Provide time frames to shut off and raise feeders and water.

It is important to refer to local legislation for feed withdrawal restrictions.

Feed and Water Withdrawal

The feed and water withdrawal processes are critical in optimizing feed conversion, plant yield, animal welfare outcomes, and preventing holding shrink and plant contamination. This is important for animal welfare so that equipment can be raised or removed to prevent bird injury during catching. It is also critically important to allow the digestive tract time to empty, preventing ingested feed and fecal material from contaminating the carcasses during the evisceration process.

Always allow access to water for as long as possible prior to catching. Only raise the water lines or sources when the catching crew is ready to enter the house. On multiple house farms only withdraw water just prior to commencing catching in each house.

Optimum recommended time for feed withdrawal is 8 to 12 hours (beginning when birds do not have access to feed in the poultry house until shackling at the processing plant). Less than 8 hours may result in excess feed and fecal residues in the digestive tract. This is a waste of the undigested feed as the feed will not be converted to meat. The excess feed residue will cause yield and processing problems in the plant. Fecal residues cause contamination of plant equipment and carcasses. Feed withdrawal in excess of 12 hours causes the intestines to lose their tensile strength, making them easy to tear and rupture during evisceration at the processing plant. This will cause equipment contamination in the plant.



Animal Welfare Tips

A team member should be responsible for ensuring that animal welfare practices are always followed and that there is strict adherence to guidelines for humane handling and catching. This person should have knowledge of poultry behavior, ensure handling is conducted to minimize risk for bird injury, and should have the authority to implement corrective actions if catching methods or equipment result in concerns for bird welfare.

Feed and Water Withdrawal (cont.)

It should be considered that live birds will be held at the plant. Even in a good holding shed or ventilated holding area, birds will continue to lose 0.25 % or more of bodyweight per hour from natural shrinkage due to moisture loss. Part of the logistical planning should include minimizing holding time to optimize animal welfare and shrinkage loss.



Preparation and Catching

Regardless of the method of catching, manual or automated, the basic factors are the same and must be planned to optimize animal welfare outcomes, human health and safety standards, and the quality and efficiency of the process.

Based on the expected catching time and arrival of the catching personnel on the farm, farm staff are responsible for removing or raising all equipment from the floor. Feed equipment should be raised or removed in accordance with the feed withdrawal program. Watering equipment should be raised immediately before catching crew personnel enter the house. When water lines are split in the center of the house, only raise the waterlines in the portion of the house where the broilers are being caught. If there are any severe delays in catching (> 2 hours), lower the water lines to allow broilers to drink and stay hydrated.

Any other equipment (enrichments, weigh scales, humidity sensors, etc.) should be removed before the catching crew arrives on the farm. The floor of the house should be clear of obstructions providing a clear path for catching staff and equipment. Clearing the floor area will prevent hazards and reduce the risk of injury to both personnel and birds. Injuries to birds and personnel are welfare issues, cause time delays and impact profitability. Lighting in broiler houses should be at a minimum level to control bird movement and stress. Use dark-out or extreme low-level lighting to produce a calming effect for the birds. Keep the entrances closed to keep the house dark.



Animal Welfare Tips

Farmers or catching staff should raise water lines right before the catching process begins. Ideally, water withdrawal should not exceed 1 hour before broiler catching begins. When water lines are separated, raise the water lines as the catching crew advances. If there are any severe delays in catching (> 2 hours), lower the water lines to allow broilers to drink and stay hydrated.

Ventilation and temperature:

Depending on the outside conditions and the ventilation equipment in the house, the temperature and air flow must be optimized immediately before and during the entire catching process. If available, use tunnel ventilation fans and evaporative pads and/or a fogging system to control the ambient temperature and the effective temperature for the birds. Catching crew staff should be trained to minimize the stress during the catching process and should be watchful for chickens with open-mouthed breathing as this is a primary sign of thermal stress.

Distribution of birds during catching:

Some congregation of birds will occur naturally when the catching personnel and equipment enter the house. However, catching personnel should be watchful for piling of birds and should use barriers to minimize the stress and congregation of the birds for extended periods. For example, use barriers to congregate birds into smaller groups. Ideally, barriers, curtains or fencing materials that are perforated and allow air to flow through the partition will help minimize thermal stress. Barriers will ensure that broilers cannot bunch or gather into large groups causing poor ventilation and / or physical injury. Be mindful of the maintenance and security of fences, barriers and curtains to prevent injury and bird damage. Defects such as bruised legs, broken wings, and scratches will cause downgrades and a loss of carcass yield and yield value at the processing facility. Do not force bird movement. Always move the containers to the birds, and never force the birds towards the containers.

Safety for birds and people:

After placing barriers or dividers to restrict bird movement, subsequent steps should be followed to keep birds calm and to reduce the risk of bird injury from catching equipment. For example, it is recommended to use “red” lights on forklifts and any automatic catching equipment that enters the house since this lighting will not scare the birds. For the safety of personnel and catching staff that are inside the house it is recommended to use reflective clothing, glow lights, or red lights on caps or vests so that good visibility and safety are prioritized. The barriers should keep birds away from areas where people are walking and where equipment is moving in the house to prevent bird injury and accidental bird death. Ensure animal welfare and safety training are conducted with the entire catching crew including the forklift operators.



To maximize bird calmness during catching, install portable door curtains to minimize sunlight in the house.

Expectations for catching:

A company must have a written catching procedure which should include, but is not limited to, 1) the maximum number of birds that can be placed in the transportation container, 2) the maximum number of birds per hand (applicable to hand catching methods), 3) expectations for active record-keeping to assess and measure welfare outcomes, 4) a corrective actions system by which any welfare concerns and the measured key welfare indicators are communicated to the catching crew, 5) a prescribed timeframe by which this information is communicated to the catching company or supervisor, and 6) defined corrective actions that must be taken if any issues or failures are noted.

Catching Methods

Manual Hand Catching:

Hand catching methods for broilers are performed by handling the bird correctly by the back or the feet. Monitor crews for bird handling to prevent bird injury. Training and supervision are always the key to achieving good results. Catching birds by the feet is the most common method of manual catching. Set a maximum number of birds per hand per person. This should be established by individual facilities based on the bird size and handling method. When catching birds by the feet, kneel or bend down to restrain the legs of the birds and carefully carry them to the transport module (never carry by head, neck or wings).



Leg Catching Method:

Standard procedure for hand-catching broilers is to catch them by their legs. Catchers should grasp birds by the lower leg only and not the drumstick to prevent bruising. Birds must never be lifted, carried, or dragged by the wing or neck. Birds must never be thrown. Catching must be conducted in a manner that minimizes bird stress and does not cause bird injury.



Animal Welfare Tips

The number of birds in the transport container will vary based on the size of the container, the size of the broilers, and the climatic conditions. However, as a minimum standard for welfare, the density in the container should allow the birds to sit (in a single layer) during transport without being on top of one another. Broilers should not be handled or caught by their wings since the skeletal structure is not mature on young birds. The manual catching method used (legs or back) should be based on national guidelines, type of transport container used and catcher training. The catching method chosen should incorporate decisions that optimize animal welfare, labor capability, speed of catching, and efficiency of loading broilers safely into transport containers.

- ✓ Catchers must be trained to correctly catch and handle the birds in a manner that optimizes animal welfare and product quality. Training and supervision are essential for quality results. Additionally, each company should have a written training program for bird catching, handling, and transportation. This training must be conducted annually for all employees involved in conducting these procedures.
- ✓ Minimize the number of steps taken and number of times the bird is handled when carrying the birds to the container. The distance the bird is carried should be as short as possible. Bring the coop, cage or container into the house where the birds are being caught to decrease the time the birds are carried. Monitor quantity (kg/lb) per coop or module to prevent high density.
- ✓ Density in the transport containers should allow the birds to sit during transport without being on top of one another (all birds should be in a single layer inside the container).
- ✓ Do not swing the birds once they are in hand, as this can injure the birds and cause downgrades in processing. This will also cause the birds to flap unnecessarily which can result in bruising, breakage and possible blood engorgement of the extremities, especially the wings.
- ✓ All birds must be placed carefully in the containers to ensure that they are in a sitting posture on the bottom of the container. Catching crews must evaluate the containers at loading to ensure that all bird heads and extremities are inside the containers. Catchers should also check the bottom of the cage or drawer style containers before moving to prevent unnecessary injury of birds.
- ✓ Catching crews should receive annual training for animal welfare and regular feedback about key welfare indicators (ex: % of DOAs, % of birds with severe injuries, % of birds with severe bruising) from the processing plant. Objective analysis of catching outcomes and incentives for catchers often yield positive results for catching efficiency and continuous improvement in welfare indicators.

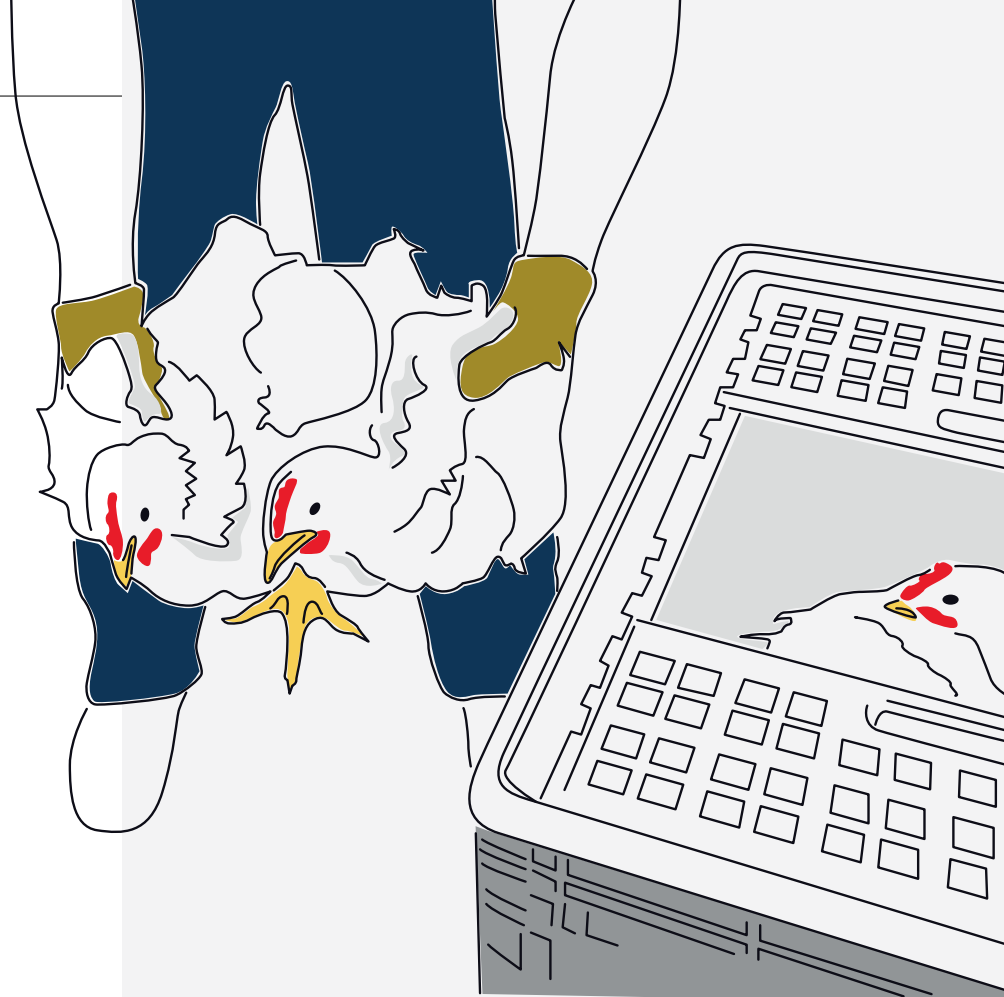

Back Catching Method:

Catchers should cup the birds by the sides, making sure wings are secure against the bird's body and wrap the catcher's fingers on the sides of the bird's breast. Place the birds into the coops, keeping the wings secured to prevent wing damage. If coops are used (as shown in the illustration), care must be taken to prevent bird injury. Sliding coops along the floor may cause toe injuries. Take care when closing the top or lid of the coop to ensure that the heads and wings of broilers are not caught when the container is closed.

Welfare considerations should be of utmost importance during catching. Special care should be given to minimize bruising and downgrades. The stockman should be present during the catching operation to ensure that the correct procedures are followed.

Monitoring bruising color can give an indication of when it happened and how to resolve the issue (see diagram right).

Possible causes of downgrades in the processing plant				
Causes	Scratching	Bruising	Broken limbs	Blisters-hock/breast
Feeding system break down	X			
Incorrect lighting program	X			
High light intensity	X			
Aggressive movement by stockman	X	X	X	
Poor feathering	X			X
Aggressive catching	X	X	X	
Poor litter				X
Incorrect nutrition	X		X	X
Plucking machines			X	
Inadequate ventilation	X			X
Poor drinker management				X

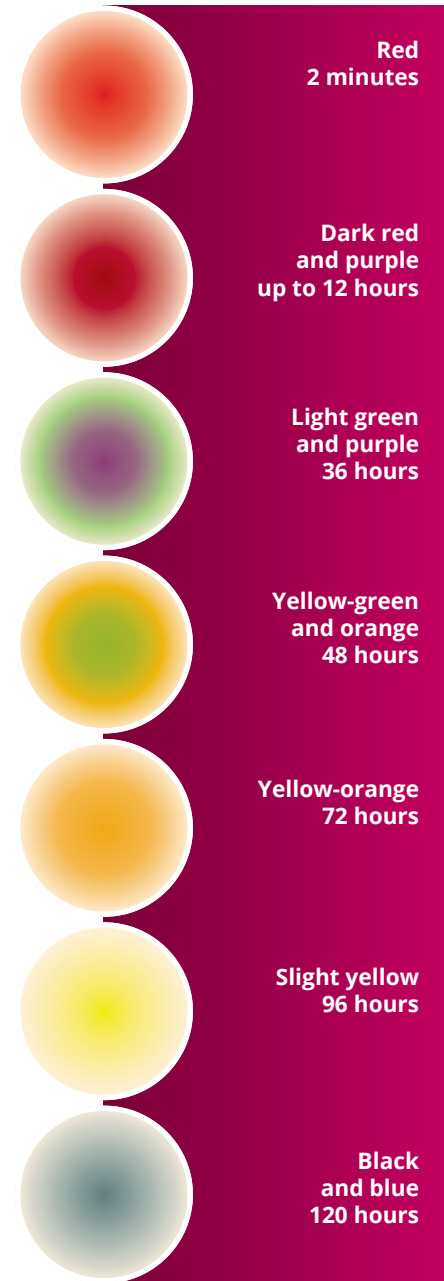

11

Record Keeping

Accurate record keeping is essential to monitor the performance and profitability of a flock, and to enable forecasting, programming and cash flow projections to be made. It also provides information to solve issues. Daily records should be maintained for each house. Flock records and annual records should be maintained by the broiler company for each farm and flock.

The following pages provide an example of record keeping for daily records for each flock.

Broiler Farm Records

HOUSE AND FLOCK DATA				CHICK RECEPTION DATA			
House Number		Feed Delivery Date		Date Received		Truck Temp.	
Date of Placement		Supplier		Time Received		Box Temp.	
Stocking Density		Amount		Number of Chicks		Age	
Number Placed		Sample Collected		Type		Weight	
Litter Temp.		Vaccine / Date		Laying Site		Hatchery	
Concrete Floor Temp		Medications / Date					
Crop fill % (24 hrs)		Water Treatments / Date					
Chick Cloacal Temp.							

COBB BROILER MANAGEMENT GUIDE

Age (days)	Mortality	Cull (small)	Cull (legs)	Cumm. Mortality	Bodyweight	Water consumption	Feed consumption	Temp. min / max	RH% min / max	Hours of Dark	CO ²	Ammonia
0												
1												
2												
3												
4												
5												
6												
7												
8												
9												
10												
11												
12												
13												
14												
15												
16												
17												
18												
19												
20												
21												
22												
23												
24												
25												
26												
27												
28												

Broiler Farm Records

HOUSE AND FLOCK DATA			
House Number		Vaccine / Date	
Date of Placement		Medications / Date	
Stocking Density		Water Treatments / Date	
Number Placed			

Age (days)	Mortality	Cull (small)	Cull (legs)	Cumm. Mortality	Bodyweight	Water consumption	Feed consumption	Temp. min / max	RH% min / max	Hours of Dark	CO ²	Ammonia
29												
30												
31												
32												
33												
34												
35												
36												
37												
38												
39												
40												
41												
42												
Total Placed					Processing Weight							
Total Mortality + Culls												
Balance												

COBB BROILER MANAGEMENT GUIDE

CATCHING DAY DATA			
Time of feed withdrawal			Medications / Date Removed
Time water line lifted			Mortalities
Time water line dropped and reason			Culls
Time catching started			
Time catching ended			
All birds removed from house	Yes	No	
House inspected post-catching?	Yes	No	

Appendices

Measurements and Conversions

Broiler Farm Contacts

Measurements and Conversions

Length:	
1 meter (m)	3.281 feet (ft)
1 centimeter (cm)	0.394 inches (")
Area:	
1 sq. meter (m ²)	10.76 sq. ft (ft ²)
1 sq. centimeter (cm ²)	0.155 sq. inch (in ²)
Volume:	
1 liter (l)	0.22 imperial gallon (IG)
1 liter (l)	0.262 US gallon (gal)
1 cubic meter (m ³)	35.31 cubic ft (ft ³)
Weight:	
1 kilogram (kg)	2.205 pounds (lb)
1 gram (g)	0.035 ounces (oz)
Energy:	
1 calorie (cal)	4.184 joules (J)
1 joule (J)	0.735 foot pound
1 joule (J)	0.00095 British thermal unit (BTU)
1 British thermal unit (BTU)	252 calories (cal)
1 British thermal unit (BTU)	0.3 watt per hour (kWh)
Pressure:	
1 bar	14.504 pounds per square inch (psi)
1 bar	100,000 Pascals
1 Pascal (Pa)	0.000145 psi
Volume Flow Rate:	
1 cubic meter per hour (m ³ /hour)	0.5886 cubic feet per minute (ft ³ /min)
1.70m ³ /h	1 cubic foot per min
Stocking density:	
1 square foot per bird (ft ² /bird)	10.76 birds per square meter (birds/m ²)
1 kilogram per square meter (kg/m ²)	0.205 pounds per square foot (lb/ft ²)
Temperature:	
Celsius to Fahrenheit	(°Celsius x 9/5) + 32
Fahrenheit to Celsius	(°Fahrenheit - 32) x 5/9
Light:	
1 foot-candle (fc)	10.76 lux
1 lux	0.0929 foot-candle

Broiler Farm Contacts

Contact	Name	Telephone Number
Flock manager		
Feed Mill		
Hatchery services		
Veterinary service		
Equipment supplier		
Electricity services		
Gas services		
Water services		
Cobb representative		
Laboratory manager		
QA / AW support staff		



www.cobb-vantress.com

L-038-01-21 EN