



Cobb Breeder

Management Guide

www.cobb-vantress.com

01	Biosecurity on the Farm	2	05	Female Feed Management from Photo Stimulation to Peak Production	54
1.1	Avian Pathogen Control Program.....	4	5.1	Female Feed Management from Photo Stimulation to Onset of Lay.....	54
1.2	Vaccination.....	5	5.2	Feeding and Its Influence on Weekly Mortality Trends.....	55
1.3	Medication.....	6	5.3	Feeding Hens after Transfer and in Production: Early and Late Morning Feeding	59
1.4	Water Sources.....	6	5.4	Bodyweight Increase from Onset of Lay to Peak Production.....	60
1.5	Rodent and Insect Control.....	7	5.5	Post Peak Feeding – Feed Reduction.....	61
1.6	Parasite control.....	9	5.6	Hen Feathering during Production.....	62
02	Pre-placement Checklist	13	06	Lighting Program Management	63
2.1	Equipment Check.....	14	6.1	Lighting Considerations when Transitioning from Rearing to Production.....	65
2.2	Brooding Design and Management.....	19	6.2	Lighting Programs.....	66
03	Post Placement Chick Management	25	6.3	Flock Sexual Uniformity.....	68
3.1	Chick Comfort.....	25	07	Water Management	69
3.2	Brooding Temperatures.....	26	7.1	Mineral Content.....	70
3.3	Chick Hydration.....	27	7.2	Microbial Contamination.....	72
3.4	Crop Fill Evaluation.....	27	7.3	Total Dissolved Solids.....	72
3.5	Beak Conditioning.....	28	7.4	Drinking System Cleanout between Flocks.....	73
3.6	Water Management.....	28	7.5	Water Sanitation and System Cleanout.....	73
04	Breeder Management	30	7.6	Water Testing.....	73
4.1	Phase 1 Brooding (0 to 4 weeks).....	34	08	Bodyweight Control, Weighing and Analysis	75
4.2	Phase 2 Rearing (4 to 8 weeks).....	38	8.1	Hand Weighing	76
4.3	Phase 3 Maintenance (8 to 12 weeks).....	42	8.2	Automatic Weighing.....	76
4.4	Phase 4 Controlled Growth (12 to 16 weeks).....	43	8.3	Analysis of Breeder Bodyweight.....	78
4.5	Phase 5 Accelerated Growth (16 to 20 weeks).....	44	8.4	Maintaining Good Uniformity.....	79
4.6	House Preparation for Transfer and Production....	45	8.5	Troubleshooting Bodyweight Control.....	80
4.7	Breeder Flock Transfer.....	51			
4.8	Sexing Errors (Sex Slips).....	52			
4.9	Preparation for Photo Stimulation (20 to 24 weeks)	53			

09	Methods for Grading Breeders	82
10	Male Breeder Management	86
10.1	Male Rearing.....	86
10.2	Transferring Males from Rearing to Production Houses.....	87
10.3	Male Fleshing or Breast Conformation.....	89
10.4	Male Feeding - Separate Sex Feeding.....	91
10.5	Male Weight Trends during Production	92
10.6	Spiking Males during Production.....	93
11	Record Keeping	96
12	Egg Handling	97
12.1	Egg Collection Methods.....	97
12.2	Egg Weighing.....	100
12.3	Egg Hygiene.....	102
12.4	Egg Grading.....	102
12.5	Eggshell Quality.....	104
12.6	Egg Storage.....	105
13	Flock Depletion	107
13.1	Breeder Farm Cleaning and Disinfection.....	108
13.2	Disinfectants.....	111
13.3	Sanitation Program Monitoring.....	113

14	Ventilation	114
14.1	Circulation Fan Installation Options.....	115
14.2	Minimum Ventilation.....	116
14.3	Fans Required for Minimum Ventilation.....	118
14.4	Negative Pressure - A Key Requirement for Minimum Ventilation.....	119
14.5	Perimeter Inlet Management and Installation.....	120
14.6	Simple Negative Pressure Test.....	121
14.7	Transition Ventilation.....	121
14.8	Tunnel Ventilation.....	123
14.9	Evaporative Cooling.....	127
14.10	Light Trap Function and Installation.....	133
	Appendices	134
	Male Rearing Checklist.....	136
	Female Rearing Checklist.....	138
	Male Production Checklist.....	140
	Female Production Checklist.....	142
	Egg Production and Quality Checklist.....	144
	Measurements and Conversions.....	146
	Abbreviations.....	148
	Breeding Farm Contacts.....	149

Cobb Quality Assurance

Cobb understands our responsibilities to protect our elite breeding flocks which supply the grandparent and parent breeder supply chain globally, and is committed to supplying disease free livestock to all our customers worldwide. To achieve this, we have developed and maintain comprehensive biosecurity programs built upon proven principles of world-wide biosecurity best practices.



Cobb has detailed written biosecurity and training programs in place, with key components that include a ban on any Cobb employees owning or having contact with non-Cobb avian species, a shower-in procedure for all persons entering a Cobb farm or hatchery, footwear and hand sanitation controls at the entrance to every poultry house, and a footwear change procedure for anyone entering housing with Cobb breeding stock. In addition to these programs, procedures are implemented to minimize risks associated with personnel movements, and there are equally comprehensive controls and restrictions on feed and drinking water supplied to Cobb chickens. All equipment and supplies entering Cobb farms are controlled and sanitized to minimize risk of disease entry.

Cobb has obtained compartmentalization certification for avian influenza and virulent Newcastle-free status globally in our breeding operations in the United States, United Kingdom, Netherlands, and Brazil. This achievement supports our commitment to a higher level of biosecurity and disease free product.

The effectiveness of our systems is constantly monitored through a comprehensive program which complies fully with (and exceeds) regional testing and regulatory requirements for our breeder flocks in all countries where Cobb maintains breeding stock. The laboratories conducting this testing are recognized and certified regionally. All Cobb flocks are tested at least once every 3 weeks for avian influenza, *M. gallisepticum*, *M. synoviae*, and *Salmonella* using both conventional methodologies and antigen-based technologies. In addition, all facilities and processes are subject to frequent biosecurity audits by both Production Department managers and independent Quality Assurance Department auditors.

Introduction

The Cobb commitment to genetic improvement of our family of products continues to increase the performance potential in all areas of broiler and broiler breeder production. However, to attain both genetic potential and consistent flock production, it is important that the flock manager has a good management program. The success of the Cobb broiler breeder worldwide has provided considerable knowledge of the breed in a wide range of environments, such as hot and cold climates, controlled environment and open housing. This Breeder Management Guide is designed to assist you in building a management program to maximize the genetic potential of Cobb products for your location.

Management must meet the basic needs of the flock but also adjust the program to benefit fully from the breed's potential. Some of the guidelines may need to be adapted locally according to your own experience or infrastructure, and to allow you to comply with any national requirements for animal welfare or animal care. Cobb's local technical service and world technical support teams will assist your operation with adapting the recommendations.

The Cobb Breeder Management guide highlights critical factors that are most likely to influence flock performance. This is part of our technical information service, which includes the Cobb Hatchery, Processing, Vaccination and Broiler Management Guides, Supplements and a full range of performance charts. Our recommendations are based on current scientific knowledge and practical experience around the world. You should be aware of local legislation, which may influence the management practice(s) that you choose to adopt.

This Cobb Breeder Management Guide is intended as a reference and supplement to your own flock management skills so that you can apply your knowledge and judgement to obtain consistently good results with the Cobb family of products.



Animal Welfare Tips

Look for this **Cobb Cares** symbol throughout the guide that highlights the Animal Welfare Tips and important aspects of management to improve poultry welfare outcomes.



*Cobb Breeder Management guide is available online under
Resources > Management Guides*

Biosecurity on the Farm

Biosecurity must encompass all the operations performed by the breeding stock caretaker. Procedures to prevent the introduction and spread of disease or contamination must be implemented at the hatchery, feed mill, farm operations, general maintenance and by personnel. An issue in any area will endanger the whole biosecurity program and the general wellbeing and productivity of the flock. All personnel must understand the importance of the biosecurity program. Biosecurity essentials include:

Animal and bird contact

- ✓ The farm team must not have contact with other birds, and possessing backyard birds is not allowed
- ✓ All team members must sign an agreement to avoid and not possess birds.
- ✓ Respect all required “no contact time” for any non-company bird contacts. Exposure to non-company flocks or birds must require a minimum of 72 hours of no contact before re-entering flocks, especially if disease threats are active in the area.
- ✓ No pet animals should be allowed in or around the poultry housing.
- ✓ Farm animals other than poultry should be fenced separately and accessed via a separate entrance.

Farm team hygiene

- ✓ Ideally a ‘shower in and shower out’ policy is regarded as best practice including a timed, five-minute, hot shower with the necessary cleansing and sanitizing agents which must be provided.
- ✓ Use dedicated changing facilities located at the site entrance for employees and visitors and provide protective clothing and footwear.
- ✓ Only essential items are permitted on the farm. Personal items such as jewelry, phones and watches are discouraged. All items that enter the farm must be disinfected.
- ✓ Use boot dips and sanitize hands prior to flock contact.
- ✓ Catching, vaccination and selection crews should be provided with protective clothing.
- ✓ Do not dry farm clothes in open air. Use of gas or electric dryers should be a protocol.

Visitors

- ✓ Everyone entering the premises must register and answer a questionnaire before entering. Keep a record of all approved visitors and their previous farm visits and/or bird contact.
- ✓ If delivery vehicles enter the farm, they must be washed and disinfected at the farm entrance. A wash bay with wheel dips and spraying facilities should be located at the farm entrance.
- ✓ All outside equipment should be thoroughly cleaned and disinfected before it comes onto the farm, and again upon arrival at the receiving house.
- ✓ Incoming traffic must be minimized.
- ✓ Any visitors who need to enter the farm must shower and change into a clean uniform. Since shower facilities can be a biosecurity risk, it is important that they are kept clean and sanitized, with designated “clean” and “dirty” zones.
- ✓ Catching equipment such as crates/modules and forklifts must be washed and disinfected before entry to the farm.



Animal Welfare Tips

Daily flock monitoring is an important part of biosecurity and welfare programs. Farmers should evaluate bird appearance and flock behavior each time they enter the house. A record of daily mortality and culls should be kept allowing farmers and flock managers to be aware of any increases that may be related to the introduction of a disease. Farmers should also know when and how to notify a supervisor or veterinarian so that health samples can be collected to verify health status of the flock.

Disease prevention

- ✓ Dispose of mortality in the correct and hygienic manner daily.
- ✓ Water should be obtained from known clean sources and not from open water supplies.
- ✓ Have a written plan in place to address disease outbreaks.

Farm barriers

- ✓ Distance between farms is a good physical barrier.
- ✓ Each farm must have a perimeter fence with a locked gate to prevent unauthorized entry of people, vehicles and animals.
- ✓ Keep grass and other vegetation controlled to prevent moist areas and discourage pest harborage. No vegetation should be allowed directly around poultry houses.
- ✓ Use adequate signage to alert outside visitors.
- ✓ Place all utility meters and equipment (e.g. gas, water and electric) outside of the farm to prevent utility trucks and personnel from entering the farm.
- ✓ Choose an isolated site when developing new parent farm facilities away from other poultry farms, rivers and ponds to limit disease risk and exposure to wild birds.

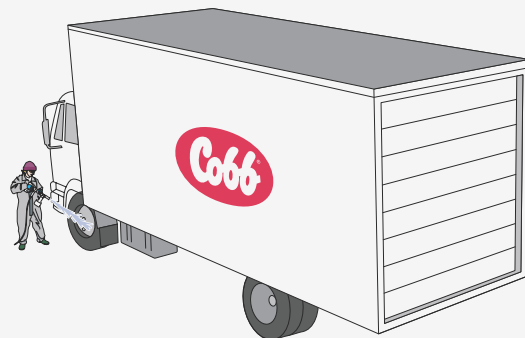

Vehicles and materials brought onto the farm are potential biosecurity risks. All vehicles should be washed prior to entering the farm. Visually inspect any delivered materials before unloading for signs of contamination (i.e. torn bags, rodent droppings, etc.)

Flock housing

- ✓ Use assigned areas for boot changing stations before entering the houses.
- ✓ Keep all doors shut and well-sealed to prevent rodent entry.
- ✓ Disinfect all equipment and supplies prior to entering the houses.
- ✓ Use wild bird proofing equipment and materials and rodent traps and barriers.

Litter

- ✓ Ideally the manufacturer should heat treat litter for drying purposes, as well as, disinfection.
- ✓ Litter material should be kept covered at every stage from manufacturer to farm.
- ✓ Litter should be stored in a secure facility that is rodent and bird proof. Treat the litter with an approved disinfectant or organic acid.
- ✓ Source new material from known approved suppliers.
- ✓ Dispose of used litter in accordance with local legislation.

Feed

- ✓ Clean feed spills immediately to reduce risk of vermin (wild bird, rodent) near the farm.
- ✓ Use clean raw materials and heat / chemically treat to prevent *Salmonella*. Follow local legislation on type of treatment allowed.
- ✓ Manage feed bins and feed systems to keep feed and systems clean and prevent mold.
- ✓ Feed delivery best practice is a feed silo outside the farm perimeter fence. Dedicated farm vehicles should move the feed from the outside silo to each house.

Flock to flock contact

- ✓ Single-age breeder farms are highly recommended to reduce the risk of cycling of pathogens and/or vaccine agents within the farm.
- ✓ All chicks should be sourced from the same hatchery, have the same vaccination status and be sourced from breeder flocks with the same health status.
- ✓ For multi-age breeder complexes, the distance between flocks of different ages should be no less than 600 m (2000 ft).
- ✓ On multi-age farms, supervisors/managers should always visit houses with the youngest source flock first. If possible, limit visits to flocks of 2 different ages.
- ✓ When visiting multiple farms in a single day, always visit the youngest flocks first.
- ✓ When visiting a farm with a suspect/known disease, visits to other farms must be delayed.
- ✓ Enforce a minimum requirement (ex: 72 hours) of “no poultry contact” before visitors can enter the farm if they come from non-challenged areas. If visitors are from areas with disease issues the down time period should be extended to 7 days.
- ✓ Depletion of birds should be complete before arrival of new chicks.
- ✓ Use dedicated weighing scales, catch screens and other equipment that is used frequently for each age group farm unit and do not move or share this equipment between different ages.

Team member training

- ✓ Establish standard operating procedures and monitor their effectiveness.
- ✓ Provide regular training sessions for all team members.
- ✓ Programs must be practical and supported from the top of the organization.

1.1 Avian Pathogen Control Program

Many countries have national poultry health programs to provide disease-free certification for poultry flocks and to help prevent and control avian pathogens. Examples of these national poultry health programs include: US Department of Agriculture National Poultry Improvement Program (USDA-NPIP); UK Poultry Health Scheme; Brazil PNSA (Poultry Health National Program). Typically, national poultry health programs include biosecurity standards, and a framework strategy for monitoring, preventing and controlling these primary poultry pathogens. Specifically for chicken flocks, pathogens normally incorporated into a national poultry health program include: *Mycoplasma gallisepticum*, *Mycoplasma synoviae*, *Salmonella pullorum*, *Salmonella gallinarum*, *Salmonella enteritidis*, *Salmonella typhimurium*, Newcastle disease and avian influenza.

If participating in a national avian health program or designing a pathogen control program for your company, the following items should help ensure compliance and disease prevention:

- ✓ Concrete floors are ideal for effective cleaning and disinfection.
- ✓ Only farm personnel should have regular access to the flocks. Farm personnel should only visit flocks for which they are responsible. Keep all houses locked to prevent unauthorized entry. A logbook recording all incoming personnel or visitors should be kept on site.
- ✓ Any contact with poultry outside of the farm, including feed store chicks, zoos, poultry shows, fairs, wet markets or exhibitions is strictly prohibited. In the case accidental bird contact happens, personnel should report this to a manager and should not enter the farm. We strongly recommend a minimum of 72-hours of “no bird contact” for any accidental bird contact before staff return to a production facility to prevent disease introduction.
- ✓ All personnel should shower and change clothes between visits to different units within a farm. If a flock is found suspect or positive, that flock should be put under strict quarantine, and visited last.
- ✓ A different set of footwear must be worn in each house. A complete set of clean protective clothing and boots must be provided for flock supervisors and visitors. Hand sanitation stations should be present at all entry doors into the chicken house and into each airspace. Disinfectant foot pans or boot scrubbers should be present at all entrances into each chicken house prior to the actual footwear change.
- ✓ Since humans can potentially transmit some species of *Salmonella* to poultry, team members with gastrointestinal issues (particularly diarrhea and vomiting) should immediately report to management before starting to work with poultry or poultry feed.
- ✓ If possible, farms should be operated in an “all-in, all-out” manner to avoid multi-age flocks. If large farms have multi-age flocks, each sector or defined zones of the farm should have specific biosecurity requirements and flocks within each house should be ‘all-in, all-out’ to ensure that health status of the flock is optimized.
- ✓ In accordance with the company veterinarian and the national poultry health program requirements, samples should be collected regularly to monitor the health status of the flock. The type of sample (swabs from birds, blood sample, or environmental sample), the quantity of samples required and the frequency of samples must be specified to ensure that health monitoring provides an accurate assessment of pathogen absence within the flock. A reliable laboratory capable of accurate testing for avian diseases and salmonella is very important.
- ✓ If samples result in a suspect or confirmed case of disease, immediate biosecurity restrictions should be placed on the house/farm to control pathogen spread and to prevent disease in other flocks. Additional diagnostic samples must be obtained to confirm the disease in the suspect house and to confirm disease absence in other houses on the farm.

All Cobb breeding stock is generated from flocks intensively monitored for specific avian diseases including *M. gallisepticum*, *M. synoviae*, *S. gallinarum*, *S. pullorum*, *S. enteritidis*, Virulent Newcastle Disease, Avian Influenza, and replicating Avian Leukosis. All flocks are monitored for *Salmonella* species and breeding stock will be *Salmonella* free of specific serogroups and serotypes depending on Cobb's standards by region.

1.2 Vaccination

The purpose of a vaccination program is to prevent losses from a specific disease, protect the progeny and build immunity. Schedule vaccinations to reduce economic loss by understanding that vaccine reactions can vary by age. Vaccination is a necessary stress, therefore pay particular attention to animal welfare methods to minimize stress. It is not possible to recommend a specific vaccination program for poultry in all areas of the world. Consult your poultry veterinarian for a program that meets the disease challenge and vaccine availability in your geographical area. See the Cobb Vaccination Guide for an overview of modern vaccination procedures.

- ✓ Only vaccinate healthy birds.
- ✓ Minimize stress following vaccination by careful flock management.
- ✓ Use the full dosage and do not dilute the vaccines.
- ✓ Do not save opened bottles for later use. All used and open vaccine containers should be properly discarded following each vaccination.
- ✓ One member of the vaccinating team should be responsible for supervising the procedure to check that the vaccine is administered correctly. Any birds that do not receive the full dose should be revaccinated.
- ✓ The number of doses administered at the end of the day should be checked against the number of doses taken to the farm.
- ✓ One qualified person should be responsible for cleaning and sterilizing the equipment at the end of each day's vaccinations.
- ✓ To determine the quality of the vaccine administration, the flock should be monitored post vaccination for any reactions (crooked or twisted necks and mortality or leg damage) depending on the site of administration.
- ✓ Monitor the health and antibody status of the flock on a routine basis.
- ✓ Read the label and follow the manufacturers' instructions for vaccine reconstitution, dilution, temperature and administration.
- ✓ Do not use outdated vaccines.
- ✓ Keep vaccines refrigerated at the manufacturers recommended temperature. Prevent exposure to heat and direct sunlight. The vaccine refrigerator should be in a clean and secure area.

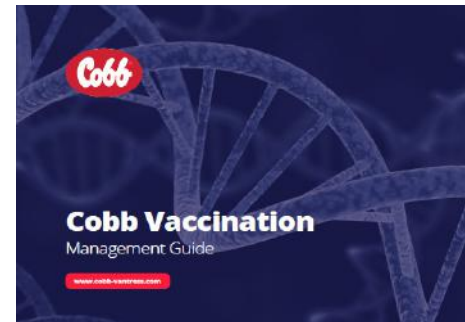

The Cobb Vaccination Management guide is available online at Cobb-Vantress.com under **Resources > Management Guides**



Animal Welfare Tips

Before and during vaccination, one person should be responsible for checking birds regularly to prevent piling in the holding and vaccination pens. A supervisor should actively check birds after vaccination to verify that vaccine placement was correct. If the vaccination of the flock will take more than 2 hours, one water line should be left down so that birds can drink after handling. Overhead lighting should not be adjusted, but head lamps and specific lighting for the vaccination area can be used to promote safety and accuracy of the vaccination process.

After vaccination, all farm crew staff should check the house to ensure that vaccination trash (ex: empty bottles) are removed and the equipment (ex: feeder, drinkers, enrichments) is returned to the correct height.

Regular welfare audits of the vaccination process should focus on bird handling, vaccine handling, bird care, culling and euthanasia, practices to minimize flock stress, and correct application of the vaccination.

1.3 Medication

Prevention is by far the most economical and best method of disease control. Prevention is best achieved by implementing an effective biosecurity program, including appropriate vaccination. However, if the flock shows disease symptoms it is important to obtain qualified veterinary consultation as quickly as possible.

Drugs and antibiotics are expensive and can confuse the characteristics of a disease, complicating the correct diagnosis. Using the correct medication and treatment timing can be crucial to combat a disease. The preferred choice of a drug for some diseases may be harmful if used for the treatment of others. For certain diseases there may not be an effective treatment or it may not be economically feasible to treat. Therefore, always submit 6 to 8 live birds showing typical symptoms to a laboratory, so that sensitivity tests can be conducted to identify medication that will be effective against the disease agent.

1.4 Water Sources

City water supplies - Due to location, many farms may not have access to water mains or city water supplies. Water sourced from city mains is generally treated and sanitized and is the most biosecure water for poultry. On occasion, city water supplies have had high levels of bacteria from events such as heavy rains, line breakage, or ground water seeping into the system. Therefore, producers should regularly test the water to confirm minimum water quality standards (see section on water quality Chapter 7). Although the water is sanitized at the source, producers should treat their water systems to control biofilm and other buildup in water systems.

Keep in mind that some water authorities may limit water accessibility in terms of flow rates from the water main. Producers should be aware of any limitations and have access to additional water storage in the event of high demand.

Well and underground water - Well water suitability is usually based on location. It is considered a very low risk for avian pathogens. However, run-off events and heavy rains can contaminate these water sources with bacteria including *E. coli*. Salinity and high mineral content (hardness) can be issues with

ground water and regular testing and treatment should be done to correct any water quality issues. In some cases, water availability may vary by season requiring water to be pumped into storage tanks. These storage tanks should be closed and the water tested regularly for contamination.

Surface water - Surface water including lakes, streams, ponds and rivers are the highest risk for sources of avian pathogens, including Avian Influenza. These water sources provide habitats to waterfowl and should never be used as water sources for poultry farms.

Alternative water sources - (rain, transported, recycled). To evaluate the biosecurity risk of alternative water sources, identify the primary source. For example, water trucked from a city water supply should be sanitary. However, the water should be tested to ensure that it was not contaminated when the truck was filled as well as by other horizontal contact such as personnel movements.



Animal Welfare Tips

Ideally, each farm should have 2 viable water sources. For example, the primary source may be city mains water and the backup source may be an on-farm well. The goal of having a backup water supply is to ensure that the flock always has an adequate, safe and fresh water source.

1.5 Rodent and Insect Control

Rodent control

Rodents are known to spread diseases to humans and animals. They can be vectors for *Salmonella*, *Cholera*, and numerous other infectious agents. Additionally, they can damage insulation, curtains, hoses, and electrical wire, as well as inflict injury and mortality to poultry. Rodents may come in through almost any opening—holes in walls, openings around pipes, cracks in doors, etc. Mice can squeeze through spaces as small as 6 mm (about 1/4 in) and rats can squeeze through a space as small as 12 mm (about 1/2 in). There should be no tolerance for rodent activity inside the poultry house, bedding storage, or feed storage areas. An effective rodent control program involves several measures that restrict shelter, food and water and should be continuously implemented. The following are important rodent control practices.

- ✓ Minimize hiding places by removing any garbage from around the buildings.
- ✓ All vegetation should be kept trimmed. Maintain a 5 m (16 ft) weed/grass free zone around the house perimeter.
- ✓ Create a perimeter of at least 2 m (6 1/2 ft) of coarse gravel around the houses. The gravel will prevent rodents from easily accessing the grounds.
- ✓ Make building entrances as rodent proof as possible.
- ✓ Dispose of dead birds properly and promptly.
- ✓ Keep feed spillage to a minimum and clean up feed spills immediately. Keep feed storage areas clean and store feed properly on pallets off the floor.
- ✓ Maintain permanent bait stations with a fresh supply of rodenticides on a year-round basis. Rotate the use of different baits on a regular program.
- ✓ Consider the installation of a rodent barrier. A metal sheet around each house or the units will keep rodents from getting close to the houses as shown in the photo below.



Insect control

Pests can cause significant losses to production by reducing productivity and transmitting diseases. Some insects can also cause physical damage including structural damage to the houses. Breeder operations can be impacted by many insect species but the primary issues are caused by flies, beetles, and ants.

Insects are attracted to poultry operations as food, water, and habitats are readily available. Chemical insecticides are not always effective as insects become more resistant to multiple pesticides. Mechanical means of control (traps) are an option and should be part of an insect control program. However, good management practices along with a prevention program are the most effective ways to prevent insect infestations.

Professional pest control companies have experts that can readily evaluate situations and help develop a good pest management program. Once established, good record keeping is a valuable tool to identifying and mitigating pest issues before they become an infestation problem.

Good management and sanitation practices

- ✓ If darkling beetles are an issue, leave the litter in the house for at least one day and treat it with an effective insecticide. The beetles will come out in mass once the birds leave the house so control needs to take place quickly. After removing the litter, cover it to keep the insects out of the litter and to contain others until it can be removed from the farm.
- ✓ Ensure that the house drains well and is ventilated correctly to prevent wet litter. Check for and repair any water leaks immediately. Insect eggs and larvae require moisture to hatch and survive, so it is important to keep the house environment dry.
- ✓ Ensure that the birds have good quality drinking water. Poor quality water can induce episodes of diarrhea and flushing which will add moisture and manure to the litter.
- ✓ Prevent high temperatures in the house which will cause the birds to drink more water.
- ✓ Repair any structural damage as these areas can be used as burrows for insects, especially darkling beetles.
- ✓ Allow at least 4 weeks of downtime between flocks. This will eliminate the food and water sources and give any applied insecticides time to work.
- ✓ Quickly remove and dispose of any mortality.
- ✓ Check for feed spills regularly and clean them immediately.
- ✓ Ensure that water around the outside of the house drains away and that any drainage systems (ditches, piping) is not blocked with debris or vegetation.

Biological control

- ✓ Several biological control agents are available for pest control. Be aware that not all of these agents are suitable for use in all climates.
- ✓ Boric acid can be applied as a pellet or crystal to control beetles and flies, but should only be applied between flocks because it can also injure animals.
- ✓ Some fungi are available that infect and kill insect larvae.
- ✓ Fly parasitoids are tiny wasps that can kill flies in the pupal stage. If using beneficial insects, be aware that many chemical pesticides can kill the pest and beneficial species.
- ✓ Ants primarily prey on other insects. Controlling insect infestations can therefore help prevent ant infestations.

Chemical control

- ✓ The choice of pesticide should be based on pest target, effectiveness, potential hazards (to humans and birds) as well as local regulations. A professional pest control consultant can provide more information about the right chemicals for your operation.
- ✓ Carbaryl based products can be used to control multiple insect species. They block the nervous system by inhibiting the enzyme acetylcholine-esterase.
- ✓ Pyrethrin based products are safe to use while birds are in the house. These chemicals are effective against ants, flies, and beetles. They cause temporary paralysis, but beetles can produce enzymes that detoxify the chemical. Using pyrethrins synergistically with other insecticides can be more effective.
- ✓ Insect growth regulators are also available which prevent formation of chitin so that the larvae cannot turn into an adult beetle.
- ✓ If any ant trails are seen moving from mounds outside the house to inside the house, insecticides can be sprayed around the house perimeter. Any ant mounds can also be treated with chemical pesticides.

Mechanical control

- ✓ There are many types of traps available that include pheromone, sticky tape, and electrical based traps (bug zappers).
- ✓ Flies will not move against the wind so fans can be used around doorways to prevent flies from entering.



Mechanical traps can be used inside and outside the houses and can be an effective way of controlling flies.

1.6 Parasite Control

Ectoparasites

Ectoparasites feed on the outside of the body and can cause considerable issues in poultry breeder operations. Ectoparasites can increase floor egg numbers as hens are reluctant to enter nests that contain parasites. Furthermore, ectoparasites can cause skin lesions which can lead to skin infections and may carry and spread diseases. A good sanitation program and use of targeted pesticides can prevent and control ectoparasites.

Mites

There are several species of mites that infect poultry. The Northern Fowl mite is usually located around the vent. Therefore, they are often found on eggs and may be detected by staff handling eggs. Scaly leg and depluming mites infest the legs and feet and base of the feathers, respectively.

If environmental conditions are good (temperature and humidity) some mites can live apart from birds for several weeks. Therefore, even with downtime, mites can survive to infect a new flock. Infestations tend to be worse in cool weather and on young birds.

Wild birds are known carriers of mites. Prevent nesting of wild birds on or around poultry houses. Mites can be carried into the house by equipment and egg flats. They live in cracks, crevices, nest boxes and walls (nest boxes and slats offer ideal habitats) during the day and feed at night. Depending on the infesting species, infestations can cause pale combs and wattles, crusty skin on the legs, and birds pulling out their feathers.

Lice

Lice chew on the skin and do not suck blood. Lice live entirely on birds and only leave the bird to attack a different bird. Control and prevention strategies are the same as those for mites. Lice will not preferentially infest one part of the body, so the entire bird should be inspected. White egg masses at the base of the feathers are the easiest way to identify a lice infestation.

Bed bugs

Bed bug behavior is similar to mites. They live in cracks and crevices during the day and feed at night. Bed bugs can survive for months apart from the birds so downtime will not alleviate a bed bug issue. Inspect cracks, crevices, and eggs for bedbugs which will appear as black spots.

Fleas and ticks

These parasites are occasionally found in breeder operations. Most pesticides that are used to treat other ectoparasites are also effective against fleas and ticks.

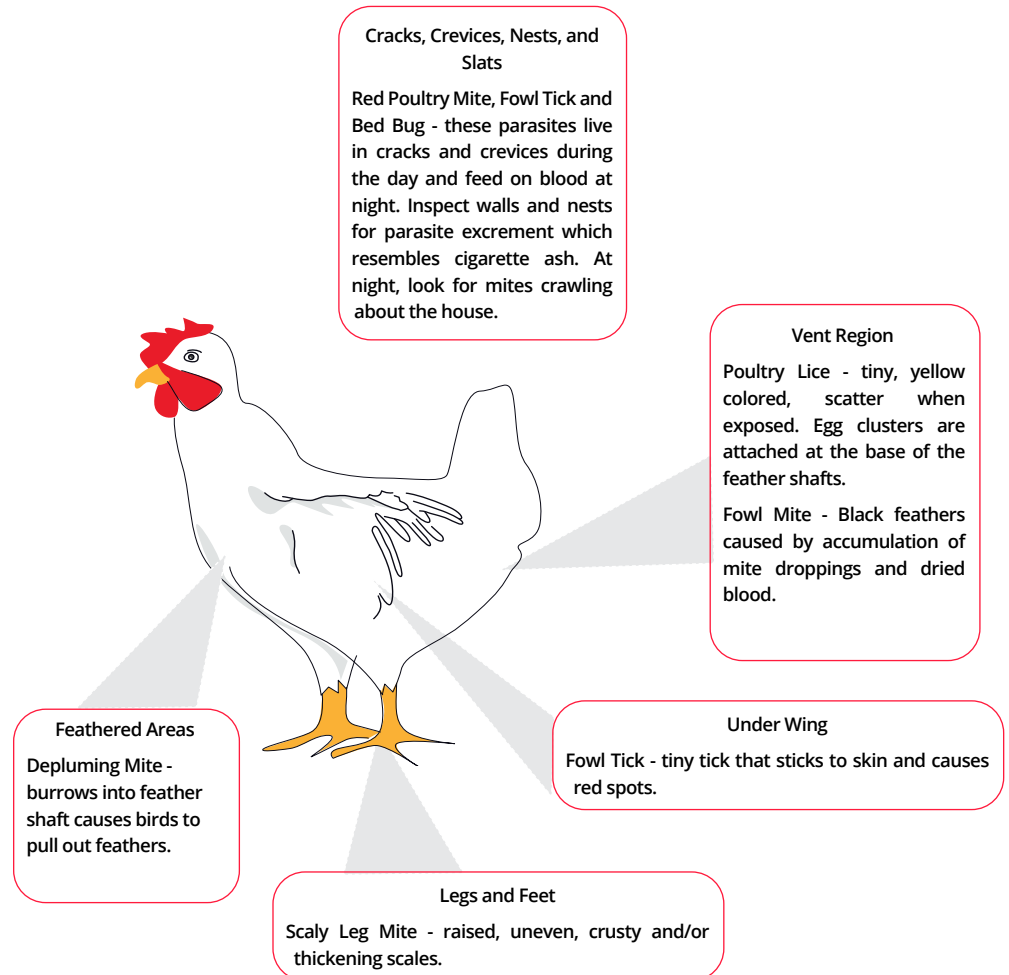

Treatment of Birds and Facilities for Ectoparasites

Bird Treatment		
Pest	Pesticide	Notes
Northern fowl mite, chicken mite, lice, depluming mite	Tetrachlorvinphos and Di-chlorvos	Do not treat more often than every 14 days.
	Tetrachlorvinphos	
	Permethrin	
	Carbaryl	
	Spinosad	
	Sulfur dust	Questions about use of sulfur may be directed to your Cobb Tech Services veterinarian.

Farm / House Treatment		
Northern fowl mite, chicken mite, lice, depluming mite	Permethrin	
	Tetrachlorvinphos	
	Tetrachlorvinphos and Di-chlorvos	
	Bifenthrin 7.9%	Do not apply as a general spray when birds are present. Do not contaminate food, feed, or water.
	Carbaryl	
Bed Bugs	Cyfluthrin	Do not apply with birds in the building. Allow spray to dry before placing birds.
	Lambda-cyhalothrin	No interior treatment with birds present. Do not contaminate poultry food, feed, or water.
	Bifenthrin 7.9%	Do not apply as a general spray when birds are present. Do not contaminate food, feed, or water.
	Cyhalothrin	
	Carbaryl	

Table adapted from "Control External Parasites of Poultry", by Jerome Goddard, Ph.D. and Gail Moraru, Ph.D. available at: http://extension.msstate.edu/sites/default/files/publications/information-sheets/is0331_web.pdf

Internal parasites

The main groups of internal parasites infecting pullets and breeders are worms (nematodes; cestodes) and protozoa (coccidia species). The most common worms afflicting poultry are members of 2 taxonomic classes, nematodes and cestodes. Nematodes are the most important roundworms and include *Ascaridia galli* (large roundworm), *Heterakis gallinarum* (cecal roundworm) and *Capillaria spp.* (hair worms). Cestodes are the most important tapeworms and include *Raillietina spp.* (large tapeworms) and *Davainea spp.* (small tapeworms).

- ✓ Worm eggs may be ingested directly, or infected earthworms may transport eggs or host partially developed larvae.
- ✓ The cecal worm eggs may remain viable for months in the environment and can carry the parasite causing blackhead (*Histomonas meleagridis*) which causes flock mortality rates of up to 15 %.
- ✓ Cestodes (tapeworms) can infect older birds. Beetles and snails can act as an intermediate host making pest control important parts of controlling parasites.
- ✓ Tapeworms are difficult to treat and control may be more easily achieved in intensive systems by controlling the intermediate hosts.

Strategic de-worming program

- ✓ The preventative deworming program should be performed during rearing.
- ✓ The strategy should be based on the degree of field challenge.
- ✓ Flocks placed on concrete floors will be less challenged compared to flocks placed on dirt floors.
- ✓ Seek local veterinary advise for the best strategy under your conditions.

Deworming via feed

- ✓ A 7-day treatment with Fenbendazole (60 ppm), Flubendazole (30 ppm), and Mebendazole (60 ppm) two times during growout (10 and 19 weeks of age) is effective.

Deworming via drinking water

- ✓ Each deworming treatment should consist of two different applications of the product with an interval of 10 to 14 days between the two. Each application should last between 3 to 4 hours.
- ✓ Under low challenge conditions, the first treatment at 8 and 10 weeks of age and second treatment at 19 to 21 weeks of age is recommended.
- ✓ Under high challenge conditions, the strategy could consist of up to 4 different treatments. Example: 3 and 5 weeks of age, then 8 and 10 weeks of age, a third treatment at 14 to 16 weeks of age and the last one at 19 and 21 weeks of age.
- ✓ The selection of the deworming product is key to a successful program. Use a broad-spectrum product that will treat as many worms possible and at different stages.
- ✓ There are many types of dewormers available but only few can treat different species of worms and at different stages. The active ingredient Levamisole hydrochloride at 40 mg/kg dosage is effective against most worms infecting poultry and at different stages. However, it can only be administered during growing.
- ✓ Piperazine is only effective against roundworms.

Coccidiosis prevention

The goal of the coccidiosis program is to help the flock develop immunity. ***Cocci drugs such as amprolium should only be given as needed as they have the potential to inactivate accrued immunity and result in subsequent coccidiosis or necrotic enteritis outbreaks.***

The prevention program consists of two very important steps:

1. **Vaccination.** Birds can be vaccinated during the first 5 days of their lives. However, spray vaccination at the hatchery provides a more controlled and effective process.
2. **Litter management at the farm.** When birds are given more space within the house, transfer litter from the brooding area and mix it with the litter in the new space. This step is critical during the first 3 to 4 weeks so chicks keep ingesting the vaccine (oocysts) from the litter to complete the vaccine oocyst cycling needed for immunity.

Important points for coccidiosis vaccination by spray cabinet:

- ✓ Coccidiosis vaccines must be stirred or agitated gently and continuously to ensure that the oocysts stay in suspension. If oocysts are allowed to settle to the bottom of the bottle, significant variation will occur in the actual oocyst dose delivered.
- ✓ Coccidiosis vaccines are generally delivered with a fan pattern while respiratory vaccines are usually sprayed with a cone-shaped pattern.
- ✓ Coccidiosis vaccines utilize a larger droplet size and the volume of vaccine delivered is approximately 21 ml (0.71 oz) per box.



At placement, chicks that have been vaccinated for coccidiosis will usually be stained (here the dye was red). The stain is an indicator of vaccine coverage and stimulates preening after vaccination and vaccine consumption. On the farm, when the brooding space is enlarged, mix some litter from the brooding area with the new space to continue the coccidial vaccine cycling.

- ✓ The reconstituted vaccine is dyed in order to stimulate preening post-vaccination and vaccine consumption.
- ✓ After vaccination, the chick boxes should be placed in an area with sufficient light to continue stimulating vaccine consumption by preening.

2

Pre-placement Checklist

The key to successful rearing lies in an effective management program starting with chick placement. Prior to chick placement, the equipment and facilities must be prepared to receive the chicks. All houses should be cleaned and sanitized. All microbiological monitoring and validation checks should be done pre-placement with enough time allowed so that the laboratory can process the samples and deliver results. For more information on house cleaning, sanitizing and microbiological monitoring, see Chapter 13.

Receiving imported breeding stock:

- ✓ Importation of day-old breeding stock requires team members to be familiar with the import procedures, documentation and any other national or local customs requirements to ensure expedited clearance of the chicks from customs.
- ✓ Transportation from the customs facility/airport must be in clean, sanitized, and climate-controlled vehicles.
- ✓ Coordinate transportation schedules, track flight arrival, and chick truck at arrival at the airport, to ensure efficient customs clearance and loading of day-old chicks for timely transportation and placement at the rearing farm.

Receiving breeding stock on the farm:

- ✓ Alert farm crew and ensure the number of personnel required are present and waiting when the truck arrives so that chicks can be placed as quickly as possible.
- ✓ If the biosecurity gate does not have a full-time security guard, arrange for personnel to be present to allow the truck entrance through the gate. If the gate does have a security guard, ensure that the guard is aware that the truck will be coming.
- ✓ The technical service team member should be present to receive the shipment.



Animal Welfare Tips

A primary objective for the rearing farm should be to prevent delays in the customs clearance and transport of chicks to the farm (for imported stock) and optimize chick receiving for all flocks. Although the yolk sac provides nutrition and hydration for the chick, efficient placement on the farm is critical to a good start for the breeder flock.

2.1 Equipment Checks

Minimum ventilation checks

- ✓ Minimum ventilation should be activated as soon as the preheating begins, to remove waste gases and any excess moisture.
- ✓ Seal air leaks to eliminate drafts on chicks.
- ✓ Check carbon dioxide level before placing chicks. CO₂ levels should always be <3000 ppm.
- ✓ If chemicals are used during the cleaning and disinfection phase prior to chick placement, adequate ventilation must be used to clear the house of the residue and to provide clean air for the chicks.

Ambient air temperature checks

Temperature sensation is affected by temperature transfer and relative humidity of the air. If air is dry with low RH % transfer is low and higher dry bulb temperatures should be used as illustrated in the table to the right.

Ambient temperature profile based on relative humidity guidelines										
Age (days)	Relative humidity									
	30 %		40 %		50 %		60 %		70 %	
	°C	°F	°C	°F	°C	°F	°C	°F	°C	°F
0	34	93	33	91	32	89	31	88	30	86
7	32	89	31	88	30	84	29	84	28	82
14	29	84	28	82	27	80	26	79	25	77

Heater checks

The key to maximizing bird performance and welfare outcomes is providing a consistent housing environment optimized for the needs of the birds. This is especially critical for young birds where a consistent ambient and floor temperature are necessary to promote good activity and normal behavior. The heating capacity requirement depends on ambient temperature, roof insulation and house sealing. Verify that all heaters are installed at the recommended height and are operating at maximum output. Heaters must be checked and serviced BEFORE preheating begins.

Generally radiant brooders used in conjunction with forced air heaters are the most efficient. Radiant brooders are used as a primary heat source during brooding while forced air heaters provide supplemental heat in cold weather.

As the flock matures, birds develop the ability to regulate their internal body temperature. At approximately 14 days of age, forced air heaters can become the primary heat source, but should only be used in well insulated solid wall houses. Radiant type heaters should be used as the primary heat source in poorly insulated houses.

Radiant / Spot brooders

Either traditional pancake brooders or radiant brooder systems are used to create floor and litter heating patterns within the house. These systems allow the chicks to move around the brood chamber and find their comfort zone. There should be some available water and feed close to this heat source.

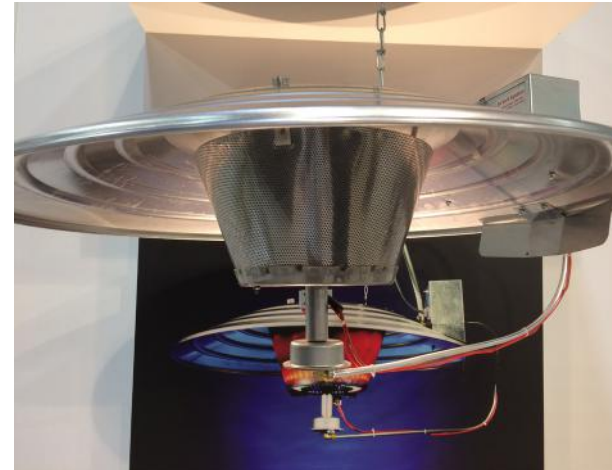

Under floor heating

This system operates with hot water circulating through pipes in a concrete floor. The heat exchange within the floor warms the litter and the brooding area.

Forced air heaters

These heaters need to be placed where the air movement is slow enough to allow optimum heating of the air, normally in the middle of the house. These heaters should be placed at a height of 1.4 to 1.5 m (4 1/2 to 5 ft) from the floor - a height that will not cause drafts on the chicks. Forced air heaters should never be placed near the air inlet because it is impossible for them to heat air that is moving very fast. Heaters placed at the inlets will lead to an increase in energy usage and cost.

Forced air heating system requirement kW/m ³ of house volume	
Tropical Climates	0.05
Temperate Climates	0.075
Cold Climates	0.10



Animal Welfare Tips

The chick is highly dependent upon the manager to provide the correct litter temperature. Chicks do not have the ability to regulate body temperature for the first 5 days and thermoregulation is not fully developed until 14 days of age. If the litter and air temperatures are too cold, internal body temperature will decrease, leading to huddling, decreased activity, reduced feed and water intake, stunted growth, susceptibility to disease, and loss of flock uniformity.

Floor temperature checks

Often concrete/litter temperature is measured quickly at chick placement in a few random areas, which is not representative of the true uniformity of concrete/litter temperatures. The best approach is to measure (both concrete/litter) every 6 meters (20 ft) along the length of the poultry house and in three rows across the width of the house. This will help identify hot or cold zones in the house prior to chick placement. The litter temperature should be recorded before each placement. This will help to evaluate the preheating effectiveness and make any necessary adjustments for future placements.

- ✓ Houses should be preheated so that both the floor and ambient temperatures and humidity are stabilized at least 24 hours before placement.
- ✓ To achieve the above targets, preheating needs to commence at least 48 hours before chick placement.
- ✓ Preheating time is dependent on climate conditions, house insulation and heating capacity and will vary from farm to farm.
- ✓ Concrete temperature (below litter) should be 28 to 30 °C (82.4 to 86.0 °F). Concrete temperature should never exceed 32 °C (90 °F).
- ✓ At placement, litter temperatures should be 30 to 32 °C (86 to 90 °F) with forced air heating.
- ✓ If radiant heaters / brooder stoves are used, floor temperatures should be 40.5 °C (105 °F) under the heat source.
- ✓ Floor temperatures should be 30 to a maximum of 32 °C (86 to 90 °F) when checked at least 1 m (3 ft) away from the center of the radiant heater or brooder stove. Above 32 °C (90 °F) feed intake decreases, and at 35 °C (95 °F) stops altogether.
- ✓ The difference between the temperature (at chick level) in the front and back of the reception area should not exceed 0.20 °C (0.36 °F). Uniform temperatures can be achieved using recirculation fans to mix the air constantly.



Thermostats or temperature probe checks

- ✓ Placed at bird height and evenly distributed around the house. Do not place directly under the heating source.
- ✓ Thermostats and temperature probes should be calibrated at least annually, or sooner if doubt exists about accuracy.
- ✓ Minimum/maximum thermometers should be placed adjacent to thermostat.
- ✓ Temperature ranges should be recorded daily and not deviate by more than 2 °C (4 °F) over a 24-hour period.

Drinker checks

- ✓ For partial house brooding, allow 40 chicks per nipple. When the house is fully opened, allow 8 to 10 birds per nipple.
- ✓ For bell drinkers, allow 75 birds per drinker. For some bell drinker designs, the lip of the drinker may be too high and the chicks will not be able to reach the water. In this case, supplementary drinkers will be necessary.
- ✓ Flush all drinkers to remove any residual sanitizer. Water must be clean and fresh.
- ✓ Adjust pressure to produce a droplet of water visible on each nipple, without dripping. Check for any specific recommendations from the manufacturer for pressure settings.
- ✓ Check for water leaks and air locks.
- ✓ Ensure that nipple drinkers are at the chicks' eye level at reception. Adjust lines after 2 days so the chicks' necks are slightly stretched to drink.
- ✓ If needed, supply 1 supplementary drinker (3.8 L, 1 gal) per 100 chicks. Supplemental drinkers should be placed slightly higher than the litter to maintain water quality but not so high that access is impeded. For example, on top of a box lid or egg flat. They should also be placed close to the primary source.
- ✓ Conduct water bacteriological analysis before chick placement to assess the quality of the cleaning and disinfection process. Check the sanitizer concentration at the end of the loops daily.



Prior to placement, check that all water lines and individual drinker nipples are operating correctly.

Feeder checks

- ✓ Run the feeding system prior to chick placement to detect any minor problems and correct any issues.
- ✓ Check feed distribution lines to ensure they are level and secured.
- ✓ For chain feeder systems, lubricate the system per manufacturer's instructions. Check the chain tension and scan the line for foreign objects that can become lodged and damage the system.
- ✓ Ensure feed hoppers are clean, dry and ready to be filled.
- ✓ Feeders should be adjusted for chick height. Initially, feeders (pan and chain) should be at ground level so the chicks can easily access them.
- ✓ Calibrate the scales used to weigh the feed prior to the flock placement. Accurate weighing of feed is critical to prevent over or under feeding the flock.



Run the feeding system and check that feed lines are level and secure.



Animal Welfare Tips

Bird comfort, water access and feed provision are critical to ensure optimal welfare outcomes for new chicks. In addition to adjusting the height of the feeder and drinker for bird height, it is important to have the on-farm feed scale or weigh bin calibrated before (or within 2 weeks) flock placement. The goal of this calibration is to prevent overfeeding or underfeeding the flock.

Maintenance

Equipment failures can be devastating and result in massive losses. A comprehensive farm plan should include regular, scheduled and preventative maintenance to prevent equipment failures. Replacement and spare parts should be available at each farm to prevent delays in repairs. An on-site, written logbook should be used to record regular checks (ex: generator testing), routine on-site repairs, and major maintenance concerns that need to be scheduled.

Major maintenance and mechanical repairs should be done between flocks and in conjunction with cleaning to minimize biosecurity risk on the farm. Pre-placement maintenance checks are very important and can help ensure the chicken house is ready to safely and comfortably house new birds. Create a written plan and checklist of areas and items that must be verified for maintenance before housing a new flock. Examples of items to include:

- ✓ **Feed** - check feed scales and calibrate weighing equipment to prevent over/under-feeding. Monthly calibration of feed scales is a good practice. Verify the clean-out process for feed bins to ensure that equipment is clean and dry prior to receiving new feed.
- ✓ **Feed delivery systems** - check augers, chains and feeder setup to ensure that the system will work to deliver feed to the birds and to ensure it is secure and will not result in bird injury.
- ✓ **Water** - check water lines and individual drinker nipples for water. Flush the water system to ensure all cleaning and disinfecting solutions have been cleared from the lines.
- ✓ **Ventilation** - check fan belts, fan motors, louvers, gas lines for heaters, etc. to ensure they will work correctly to maintain the appropriate temperature for bird comfort. Ventilate the house prior to receiving birds to remove chemical odors from the cleaning and disinfection process. Calibrate sensors and thermometers to ensure controller settings will be accurate.
- ✓ **House structure** - cycle (check) all curtains and vent doors to ensure cables are not tangled or broken which could impact the effectiveness of the ventilation equipment.
- ✓ **House equipment** - replace any broken or flickering light bulbs in the house, verify safety and security of any dividers or other bird equipment (ex: slats, nests, catch frames, scales, etc.) so that any repairs can be made prior to flock arrival.
- ✓ **Emergency equipment** - test the generator to ensure that it is working correctly to provide immediate backup power for the farm during an emergency. Generators should cycle under load once per month to ensure they are operational. Have an electrician or generator specialist conduct an annual review of the generator. Test the alarms, alarm system, etc. to verify that audible alarms are functional and radio/automated alarms contact the correct person(s) for an emergency.
- ✓ **External environment** - visually verify the conditions of the house (ex: cool cell pads, security of doors and drainage equipment, security of perimeter fence, vegetation and vermin control boxes, etc.) to ensure that biosecurity and premise security are functional.

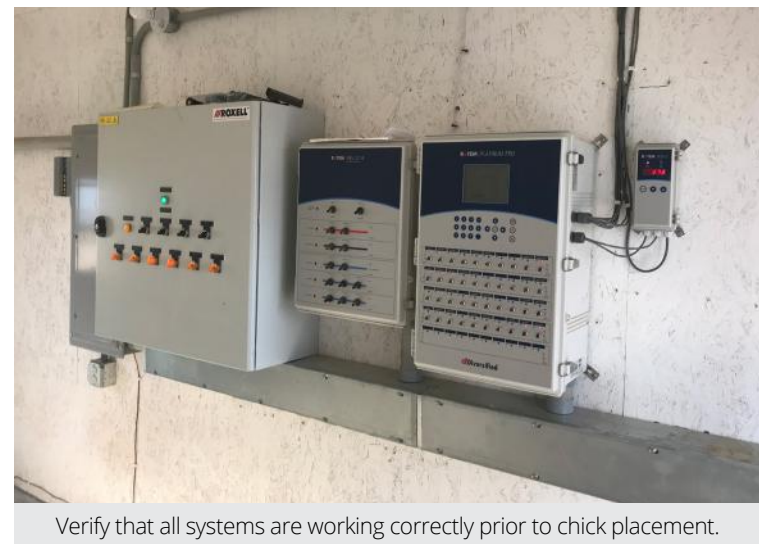

Verify that all systems are working correctly prior to chick placement.

Alarms and emergency planning

Issues may arise that require emergency responses. Minor events (power or equipment failures) and major events (severe weather, flooding, wind damage) can occur that can cause damage to housing and limit or prevent access to necessary resources including feed and water. As a minimum, breeder operations should have a written plan for emergency responses that includes standard operating procedures (SOPs) to assess and repair structural damage, loss of power, loss of water, notifiable disease presence (on the farm or in the regional area), catastrophic issues causing the inability to deliver feed, and emergency depopulation.

Alarm systems should be used to constantly monitor the chicken house environment and housing systems (temperature, water availability, electricity, etc.) that are critical to supply the daily needs of the flock. Ideally, backup systems such as generators for electricity and a secondary water supply should be present on-site and should be regularly monitored. Contact information for emergency response services and staff responsible for addressing emergencies should be posted in a place where the information is easily accessible.



2.2 Brooding Design and Management

The goal of the brooding chamber design and management is to increase the size of the brooding area as quickly as possible, while maintaining the correct house temperature. Heat and ventilate the unused area to the correct temperature at least 24 hours prior to expanding the brooding area. Generally, the rearing house partitions should be completely open after 14 to 16 days, varying according to the final density capacity and the house structure conditions.

The placement density in the brooding chamber will depend on the size of the brooding area and the equipment. Initial stocking should not exceed more than 55 to 60 birds per m² (0.18 to 0.20 ft² per bird). Ensure adequate drinking space, especially during summer placements - calculate 40 birds per nipple if nipples are easily activated.

Brooding chamber stocking density		
Age (days)	Density (birds per m ²)	Density (ft ² per bird)
0 to 3	55 to 60	0.18 to 0.20
4 to 6	40 to 45	0.24 to 0.27
7 to 9	30 to 35	0.31 to 0.36
10 to 12	20 to 25	0.43 to 0.54
13 to 15	10 to 15	0.72 to 1.08



Animal Welfare Tips

If the house setup does not allow brood chamber curtains to be used, the entire house should be heated and ventilated to optimize chick comfort and temperature needs. To maintain the chicks in a smaller brood area during the first week, lighting and/or brood dividers can be used. For lighting, keep lights on in the brood area to encourage chick activity and to eat and drink. Keep the lights off in the rest of the house. Chicks will rarely stray into the dark (unlit) areas of the house and will therefore remain in the brood area. If brooder guard (paper, metal or wire partitions) are used, they should be carefully positioned to prevent chick entrapment and injury. Ideally, litter should be used to "seal" or fully cover the bottom of the brooder guard and stable partitions should be used to ensure the divider remains vertical.

Stocking density

Chicks from donor sources of a similar age should be placed together in the same pen (or house) upon arrival at the farm. Rearing these groups together will improve subsequent flock uniformity.

Correct stocking density is essential to ensure great performance during rearing. In addition to performance and uniformity, correct stocking density also has important welfare implications. To accurately assess stocking density, factors including climate, housing types, ventilation systems, processing and welfare regulations must be considered.

It is most important to remember that stocking density throughout rearing and production are guided by both feeder and drinker space requirements. Feeder space is the most important space requirement regardless of age. If feeder space requirements are not met, flock uniformity will suffer as birds compete for available feed. Drinker space is similarly important as birds must drink water to digest feed. After finishing the feed there will be some competition for water access.



Floor space recommendations		
Time frame	birds per m ²	ft ² per bird
Pullets in rearing		
open sided rearing	6	1.79
dark out rearing*	7 to 10	1.54 to 1.08
Production		
floor-open sided	5 to 5.5	2.15 to 1.96
floor-tunneled	5.5	1.96
floor-tunneled with pad cooling	6.0	1.79
slatted - EU style	6.0 to 7.0	1.79 to 1.54
slatted - US style	5.5	1.96
Males in rearing		
open sided rearing	2.5	4.3
dark out rearing	3.0	3.6

*Modern dark out rearing can support up to 10 birds per m² (1.08 ft² per pullet) with enough feeder and drinker space and correct ambient temperatures and air quality.

Cobb recommends that males be reared separately from females from placement to transfer or mixing (approximately 20 to 23 weeks). This practice will allow farmers to optimize frame size, uniformity and bodyweight targets of both males and females. Males should be given extra floor space during rearing to ensure they achieve their target bodyweights. Males will be significantly heavier than the females at the same age. Therefore, bodyweight control is essential for uniform frame size development and sexual synchronization with the females.

Supplementary drinkers

Many modern poultry houses are well-equipped with drinker systems that can be used by chicks at placement. When possible, use only the primary drinker systems so chicks will learn to use the system as quickly as possible.

If supplemental drinkers are necessary, open trays are not recommended since chicks may immerse themselves in these and / or contaminate the water with litter and feed which results in poor water quality. Supplemental drinkers should never be placed directly beneath the brooders as this will heat the water and it will become too warm to drink as well as increase water evaporation.



Supplementary feeders

Supplemental feeding equipment should not be placed directly under or too close to the brooders and feed should be distributed just prior to the chicks' arrival. Provide one feeder tray for every 75 chicks at day old and ensure that supplementary feed remains fresh. Remove supplementary feeder trays after day 7.

Another option is to place a total of 30 g of feed per bird on paper covering 50 % of the placement area. This feed allocation should be consumed within the first 3 days. The paper used must be durable and resistant to puncture. We do not recommend used newsprint or other kinds of re-used paper because of biosecurity related risks and material quality. Remove any remaining paper after the feed is consumed.



Animal Welfare Tips

Carefully observe chick distribution and behavior as the brooding area is expanded and chicks are given more space. Chicks are naturally curious and will want to explore, but will still need to have the correct temperature, lighting and ventilation to ensure they are comfortable, remain active, and easily can find feed and water within the expanded area. If supplemental drinker and / or feeder trays are used during brooding, they should be gradually removed from the brooding area over the period of several days before the house is completely opened. Pre-fill drip plates under nipples with water to stimulate water consumption soon after chicks arrive.

Litter management

Cover the whole floor with new, fresh litter. It is important that the litter material provide a soft, dry surface that conducts radiant heat. Level the bedding by raking and compressing firmly. Uneven litter creates uneven floor temperatures, causing groups of chicks to huddle in pockets or under equipment. Uneven litter can also result in unintended restricted access to feed and water at this critical time of development.

Litter height depends on the floor insulation, the use of plastic below the concrete floor to prevent capillary action of water, summer and winter conditions, ventilation and bird densities. Try to use the least amount of litter possible so that it is easier to work in the litter and maintain the litter height level. The litter will accumulate bird droppings from rearing through production. A good reference is to use 3 to 5 cm (1 3/16 to 2 in) in summer conditions and 5 to 7 cm (2 to 2 3/4) in winter.

Enrichments

Enrichments are considered to be beneficial as they may reduce “negative behaviors” and may increase “positive behaviors” for poultry. Enrichments typically consist of sensory stimuli that provide choice(s) for the animal within the environment. The object or device may result in a change in behavior/activity related to social interaction (ex: increases or decreases direct/indirect contact with other animals), occupational outcome (ex: encourages exercise or a challenge in the environment), physical outcome, sensory stimulation (ex: visual, auditory) or nutritional stimulation.

For poultry, welfare-related goals for incorporating enrichments into the rearing and laying environment include: increase behavioral diversity; reduce the frequencies of abnormal/negative behavior; increase the range of normal behavior(s); increase positive utilization of the environment; and increase the ability of the animal to cope with challenges or changes. Additionally, for poultry, flock performance-related goals of incorporating enrichments can include: improved flock mixing in scratch areas; reduction in floor eggs; improved foot and leg health; reduced breeder flock mortality; and improved total egg production for the breeder flock.



Enrichments should not adversely affect the health and welfare of the flock (i.e. enrichments that pose an injury or entrapment threat should not be used), should not increase biosecurity risk, and should not be economically deleterious.

Typical enrichments that can be used in broiler breeder farms include physical enrichments (ex: ramps, perches and platforms (slats) or items that provide additional shelter (small huts/tents)), nutritional and social stimuli to increase foraging or dust-bathing activity (ex: bales, pecking blocks, feed scattering), and sensory stimuli (ex: lighting or noise stimuli to train poultry). It is important to note that not all enrichments can be used in both rearing and production and should therefore be carefully planned and implemented for the age and type of chicken. Other enrichments, such as slats and perches, may be used in both rearing and laying farms to encourage birds to experience raised equipment and different flooring types so that they will acclimate more quickly to production house configurations where slatted floors and elevated perches are commonly used. Chain feeders in rearing should be managed for height so that all birds have easy access to feed but at the same time require the birds to only jump on and over the tracks to enhance mobility and activity. Having a feeder track with legs can permit the birds to perch.

Lighting

The intensity and distribution of light alters bird activity. Correct stimulation of activity with lighting during the first 5 to 7 days of age is necessary for optimal feed consumption, digestive and immune system development and good welfare. Light intensity should be 60 to 100 lux (6 to 10 fc) directly below the light and measured at chick height to enhance chick activity and encourage good early feed and water intake. Concentrating light around the nipple line will attract the chicks and improve early water and feed intake as they learn from each other.

Chicks should be given 23 hours of light at placement. At 4 days of age, start reducing the light period. Always turn the lights on at the same time every day. When adjusting the lighting period, always change the lights out time. By reducing light intensity every day by 1 or 2 hours, the recommended 8-hour day length will be achieved by 14 days of age. We recommend continuing 8 hours of light with 2 to 4 lux light intensity until photo stimulation depending on the light source (See Chapter 6).

Light intensity should not vary more than 20 % from the brightest to darkest place at floor level. Different light sources can have wide variations in light intensity at bird level. Uniform light distribution (>80 %) in rearing will help to maintain even litter levels across the house, maintaining a consistent height from the litter to the chain or pan feeders. This is important for all females to easily access feed at the same time. With uneven light intensity distribution in the house at bird level, the birds tend to scratch litter in the brighter areas causing uneven heights along the feeder track. Uneven access to feeders then will contribute to poor flock uniformity.

Do not increase light intensity during vaccination, bird weighing and grading. All maintenance work to the house should be done during the 8-hour lights on period. Increasing or decreasing light intensity will make birds less sensitive to photo stimulation after 21 weeks of age. A long day length (>10 hours) in rearing will delay sexual development of both females and males and should be prevented.

Lighting schedule for chicks during brooding												
Age (days)	placement	4	5	6	7	8	9	10	11	12	13	14
Hours of light	23	21	19	17	15	13	12	11	10	9	8	8
Light intensity (lux)	60 to 100	20	20	20	20	10	10	10	10	10	10	2 to 4
Light intensity (fc)	5.6 to 9.3	1.9	1.9	1.9	1.9	0.93	0.93	0.93	0.93	0.93	0.93	0.19 to 0.37



Chick Placement

Before unloading chicks at the farm, the floor and ambient temperature should be verified. If the house is too cool, chicks should remain within the climate-controlled chick truck to prevent thermal stress. During the receiving process, verify the box identification to ensure that the male and female chicks are placed in the correct pen or house. Careful and strategic placement of chicks in the brood area is important for animal welfare.

Pay attention to these items when placing chicks to optimize chick comfort, security, and quality:

Handling (action)

All staff should take care when handling chick boxes during unloading from the truck, when transporting them within the house, and during the placement process. The goal should be to prevent rough movement (ex: tilting chick boxes, dropping chick boxes, etc.) as this can potentially injure chicks. Ideally, boxes should always remain level until each individual box is tipped for chick placement.

Handling (method)

Farm staff must gently place the chicks in accordance with company drop height limits. The drop height should be no greater than 2 times the bird height (about 15 cm (6 in) for chicks). This means that the person must hold the box securely with both hands and tipping (below knee level) should minimize the drop distance from the bottom of the box to the litter.

Handling (location)

The location where chicks are placed is critically important. Chicks should be gently placed directly on litter, starter feed lids, or the paper that has starter feed. Do not place chicks on top of solid equipment (ex: feeders or drinkers) or on top of other chicks. When placing chicks on the litter, chicks should have easy access to water and feed, and should be near but not directly underneath a brooder.

Handling (strategy)

Ideally, chick unloading should be quick and efficient to minimize exposure to external climates that may result in thermal stress for the chicks. Ideally, all boxes should be placed in the house or brood area so that chicks will be evenly distributed from the first moment of placement. Once boxes are distributed, begin at the back of the house or brood area and place chicks in a careful and calm manner as you move towards the front of the house. This will help prevent chick injury and chicks being around the feet of the staff during the reception process. Try to talk as little as possible. Chicks are looking for the mother hen and they should not associate voices as being the mother hen. Remove all paper liners, chick boxes, lids, etc. during the process to prevent areas of potential entrapment for the chicks, and dispose of these items in a biosecure manner. After placement all staff should leave the house for 2 hours to let the chicks become acclimated to the reception area.



3

Post-Placement Chick Management

The importance of the brooding period cannot be over emphasized. The first 14 days of a chick's life sets the precedent for good performance. Extra effort during the brooding phase will be rewarded in the final flock performance.

3.1 Chick Comfort

Check chicks 2 hours after placement which will give them time to settle and identify the reception area. Ensure they are comfortable. Chick distribution and behavior should be closely monitored after placement and within the first 24 to 48 hours of brooding. It is normal to see some chicks sleeping, some chicks eating or drinking, and some chicks actively exploring their new environment. If you observe chicks panting, huddling, chirping loudly or irregularly distributed within the brood area, investigate the cause(s) immediately. If not corrected, they can have a negative impact on flock welfare and performance outcomes.

While placing chicks and checking during the brooding phase, staff should talk at a low level and move calmly through the house to minimize stress. After ensuring that all chicks are placed and comfortable, staff should leave chicks alone for a minimum of 2 hours to allow them to acclimate to their new surroundings and to rest.

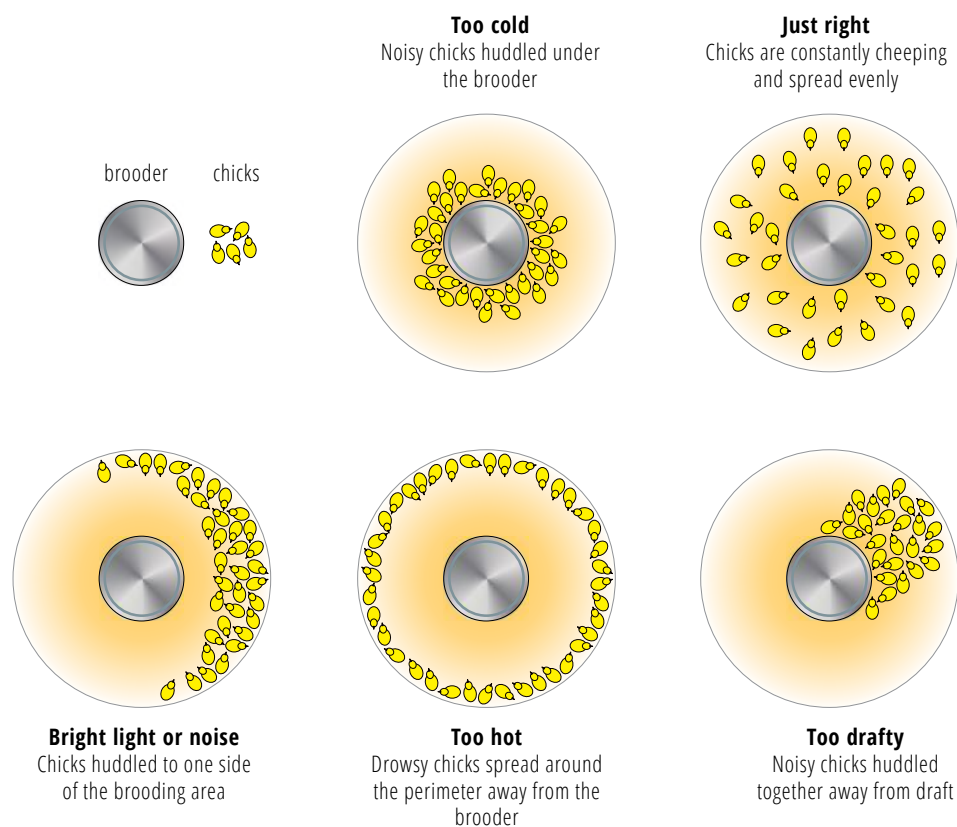

Animal Welfare Tips

Every time you enter a poultry house, you should see some birds eating, playing, drinking, chirping, and resting. Birds should never be huddling. Careful observation of chick distribution within the brooding area and observation of chick activity can assess the comfort level of the chicks. If distribution is irregular, if activity level is extremely low, or if chicks are extremely noisy, these can be signs of possible stress and the reason(s) should be immediately investigated. Remember the letters F.L.A.W.S. (feed, lighting, air quality, water and space/staff actions) as these can all impact chick welfare, distribution and behavior.

3.2 Brooding Temperatures

Cold chicks will huddle with reduced activity, resulting in reduced feed and water intake and therefore reduced growth rate. If they are comfortably warm, the chicks should be evenly and actively moving around the brooding area.

An excellent indicator of floor temperature is the temperature of the chick's feet. By placing the chick's feet against your neck or cheek you can learn how warm or cold the chick is. If the chick's feet are cold, the internal body temperature of the chick is also reduced. If the feet are cold, re-evaluate preheating temperature and current ambient/floor temperatures within the brooding area.

Chick internal temperature can be measured using a small rectal probe thermometer with a soft tip. Quick-reading, digital thermometers are recommended for these chick checks.

Hatched chick internal temperature should be 40 to 40.6 °C (104 to 105 °F). Chick internal temperature above 41° C (106 °F) in first 4 days can lead to panting. Chick internal temperature below 40 °C (104 °F) indicates that the chick is too cold.



At hatch, the chick cannot adequately control its body temperature and is dependent on the environment for heat to thermoregulate. When temperatures are too high or low, the chick must compensate through panting or metabolizing energy to produce heat. Either scenario has a negative impact on weight gain, growth and welfare outcomes. Since chilling or overheating during brooding can result in poor growth, poor feed conversion and increase the susceptibility to disease, providing the correct temperature in brooding can ultimately have an impact on production performance.

At 12 to 14 days of age, the chick will have the full ability to regulate its own body temperature. To compensate for the changes in chicks' internal body temperatures, the size and heat production of the birds, and the development of thermoregulatory abilities, the brooding temperature must be adjusted every few days (see table).

Temperature conditions in the brooding area must ensure adequate comfort for the chicks. Optimal temperatures allow the birds to be distributed across the brooding area with proper access to water and feed. Monitor bird behavior often as this is a good indicator of chick comfort.

Temperature guidelines at relative humidity of 60 %		
Age (days)	Floor Temperature	
	°C	°F
1 to 3	31	87.8
4 to 7	30	86.0
8 to 15	29	84.2
16 to 18	28	82.4
19 to 21	26	78.8
22 to 24	24	75.2
25 to 27	22	71.6

*These figures should only be used as guidelines.



Animal Welfare Tips

When sampling chicks to verify body temperature, it is important to prevent stress and injury for the chick. If using a quick-reading, digital thermometer for cloacal temperatures (as shown here), carefully insert the metal tip of the thermometer into the cloaca. Securely hold the chick while supporting the entire body of the chick during the verification process.

3.3 Chick Hydration

The yolk contains 1 to 2 g of moisture so the chick will lose weight but not become dehydrated. If chicks start panting, they can lose 5 to 10 g of moisture in the first 24 hours and then dehydration will occur. Higher relative humidity will reduce moisture loss but also impair heat loss, so correct brood temperature is vital. Chicks from smaller eggs (younger breeder flocks) require higher brooding temperatures because they produce less heat.

The yolk contains 2/3 fat and 1/3 protein with the fat for energy and protein for growth. If early feed consumption doesn't take place the chick will use both fat and protein in the yolk for energy, resulting in inadequate protein levels for growth. Early feed intake is crucial for chicks to sustain metabolic processes such as internal body temperature.

3.4 Crop Fill Evaluation

The main objective of management during the first hours after placement on the farm is to achieve as much intake of water and feed in as many chicks as possible. Failure to achieve this objective will lead to irreversible problems with flock performance including poor growth, poor feed conversion and poor flock uniformity.

Sample 100 chicks per brooding area. If the crops of the chicks are checked 8 hours after placement a minimum of 85 % of examined chicks should have both feed and water present. A minimum of 95 % of the bird's crops should be filled upon examination the morning after placement.

If too many crops are hard (> 15 %), immediately evaluate water availability, water temperature, flow rate, etc. to determine why chicks may not be accessing water in the brood area.

If too many crops are soft (> 15 %), immediately evaluate feed availability, feed location, feed presentation (uniformity and smell), and verify that the correct feed was delivered to the farm. Check ambient temperature and floor temperature as well to determine why chicks may not be accessing feed in the brood area.



Animal Welfare Tips

If lighting and temperature in the brooding area are optimal, chicks should naturally and quickly explore the brooding area to find feed and water. Evaluating chick behavior regularly within the first 24 hours of placement and objectively measuring crop fill is an easy way to verify correct setup and optimal conditions for chick comfort. If too many crops are hard, immediately evaluate water availability, water temperature, flow rate, etc. to determine why chicks may not be accessing water in the brood area. If too many crops are soft, immediately evaluate feed availability, feed location, presentation (uniformity and smell) of the feed ration, and verify that the correct feed was delivered to the farm to determine why chicks may not be accessing feed in the brood area.

3.5 Beak Conditioning

Beak conditioning can be done in the hatchery at day of age or between 4 and 5 days of age on the farm. In the hatchery, this procedure is performed by trained personnel and typically involves specially designed, automated equipment that provides an infrared treatment for the tip of the beak. Conditioning the beak at 4 to 5 days on the farm requires more labor and special attention to ensure that bird stress is minimized.

Beak conditioning can have a positive net welfare benefit since it results in an optimal beak shape for breeders for eating and drinking, and it also can prevent aggressive pecking, a behavior that can lead to bird injury, skin trauma, and mortality. Moreover, if the top beak is significantly longer than the lower beak (hawk's beak shape) the bird's ability to drink and eat may be impaired. A longer beak on top may also negatively impact the mating efficiency of the rooster since he may have difficulty holding the neck feathers of the hen.



Evaluate the shape of the beak at 16 to 19 weeks of age. The beak should be rounded at the tip and the bottom and top should be even as shown in the picture.

- ✓ The beak continues to grow as the bird ages and must be kept in good condition for eating and drinking. At various stages during the bird's life, technical managers should evaluate the shape of the beak.
- ✓ Beak conditioning is especially beneficial for birds raised in open-sided houses or without controlled light intensity during rearing. Birds raised in houses without controlled lighting will normally have more beak growth and mature earlier than birds reared for 20 weeks in light-controlled (dark out) houses.
- ✓ Gentle pecking at feathers and objects in the environment is considered normal behavior.
- ✓ During individual bird vaccination (16 to 19 weeks of age), the shape of each bird's beak should be carefully evaluated. The correct beak shape is necessary for eating and drinking, which, in turn, will promote maximum fertility and uniformity of the flock.
- ✓ The beak reconditioning equipment should only be operated by trained personnel to ensure minimal stress for the bird.
- ✓ Only the keratinized tip of the beak (clear portion) should be removed when reconditioning the beak tip.
- ✓ If the beak deformity is severe or a beak reconditioning is not possible, the bird should be removed from the flock and humanely euthanized.

3.6 Water Management

Ensure that both feeders and drinkers are in adequate supply, relative to the stocking density, and near each other. It's important that these areas have the correct ambient, floor and litter temperature, protecting the chicks' thermal comfort zone.



Animal Welfare Tips

Water is important to promote good health and optimal welfare outcomes for chickens at all stages to:

- * achieve freedom from thirst by providing clean, cool water to birds
- * prevent stress by having water easily available (height of drinker and flow rate) to all birds
- * prevent thermal discomfort by having water available to birds so that they can cool down by drinking
- * achieve ideal welfare outcomes by maintaining drinkers to limit drips and leaks
- * promote health by providing water to birds for optimal digestion and hydration

Supplemental drinker check

The supplemental drinkers should never be allowed to become completely empty (dry). Drinkers must be cleaned and refilled as necessary. Maintain maximum water levels in the supplemental drinkers until chicks are large enough to create spillage. Supplemental drinkers should be removed approximately 48 hours after placement. Water spillage and waste should be kept to a minimum especially during cold seasons because of lower air exchange to eliminate moisture during these months.

Nipple drinker check

Nipple drinker height should be at chick's eye level for the first 2 days and then maintained slightly above chick's head at a height that the birds have to stretch slightly to reach. The birds' feet should always be flat on the litter. A bird should never have to stand on its toes to drink. Pressure should be such that there is a droplet of water suspended from the nipple. As a general guide, a nipple flow rate of 25 to 30 ml per minute is recommended in the first week. However, always refer to the manufacturer's instructions.

Ideal water temperature is between 10 and 14 °C (50 and 57 °F), however birds can tolerate a wide range of water temperature; even so water temperature should never be greater than 25 °C (77 °F). If this occurs the drinking system must be flushed at least 3 times per day.

Bell drinker check

Frequent assessment and adjustment are essential. The bell drinker water level should be 0.5 cm (1/4 in) from the lip of the drinker at day of age and reduced gradually after seven days to a depth of 1.25 cm (1/2 in) or thumbnail depth. Bell drinkers must be cleaned daily to prevent buildup of contaminants. If necessary, in hot climates, flush the water system at least two to three times daily to maintain a correct water temperature. All bell drinkers should be ballasted to reduce spillage.

Flushing water systems

All poultry watering systems should be flushed daily, but at a minimum of three times per week to remove biofilm and control water temperature. If water systems are not flushed regularly, biofilms can form on the inside of the pipe decreasing water flow and quality. High pressure flushing requires having adequate volume and pressure. One to two bars (14 to 28 psi) of water pressure will create the velocity and turbulence in the pipe work to remove biofilm. In warm or hot climates, it might be necessary to flush more than once a day to cool the water temperature. There are automatic flushing systems that make the flushing job easier, saving the producer time and ensuring the water flushing happens. For systems with flush modes, set to flush at 2 seconds per meter (3.3 ft) of drinker line.



The birds' feet should always be flat on the litter. A bird should never have to stand on its toes to drink.

Nipple drinker flow rate*

Age (days)	Flow rate (ml per minute)
0 to 7	25 to 30
8 to 14	35 to 40
15 to 21	45 to 50
22 to 28	50 to 55
29 to 35+	55 to 60

*These rates are only guidelines. Check for manufacturer's specific settings.

4

Breeder Management

The main objective of any broiler breeder operation is to produce fertile settable eggs that, when hatched, will supply the necessary quantity of good quality chicks to meet the broiler production demands. Management in the first week post hatch is a major contributor to any successful breeder management program. Key indicators of flock performance are the average bodyweight, and flock uniformity as well as mortality at day 7. Achieving good flock uniformity during the production phase can be attributed to the technical work done during the rearing phase. However, it is not enough to rely on knowledge and technical skills. Plan, organize, perform and monitor key performance indicators including rearing and production bodyweight curves and feed consumption. It is important to monitor these key indicators and respond early to issues.

The standard bodyweight curve during rearing is a prime example of one of these indicators. Failure to maintain a rearing flock on the standard bodyweight curve can have considerably negative consequences on flock productivity. Managing and monitoring feed consumption requires attention to feed formulation, ingredient choice and feed form to ensure predictability with regards to intake and bodyweight response compared to the standard grams/bird/week. Breeder bodyweight management is also dependent upon the quality of weighing and feeding equipment.

Males should be raised separately from the females up to 20 to 21 weeks of age for best results. Rearing can be broken down into 5-time frames each consisting of 4 weeks and each time frame having important factors involved in the bodyweight curve.

Rearing Phase	Time Frame (weeks)	Important factors relating to bodyweight within the time frame
1	0 to 4	Brooding and rearing factors have a critical impact on frame size and uniformity for the life of the flock.
2	4 to 8	Important for the establishment and correction of flock uniformity.
3	8 to 12	During this stage the birds should have a carefully controlled feeding program and be closely monitored to prevent them from becoming over weight and over fleshed.
4	12 to 16	Puberty begins and the birds will slowly start to increase their fleshing and overall conditioning.
5	16 to 20	Considerable increase in growth rate "turn up" to prepare for sexual development and achieve the desired uniformity and fleshing. By 20 weeks of age, abdominal fat reserves should be developing. These reserves are independent of bodyweight but closely linked to the female fleshing score.

Feed intake

Feed intake time, or feed cleanup time, is a key consideration in both the rearing and production periods. Cleanup times will vary over the rearing period and depend on several important factors including feed amounts, genetic line, the type of feeding program, the feed form presented and light intensity being used in the house.

In the rearing period, pullets will start rapidly cleaning up the feed during the controlled growth phase. Allow a feed cleanup time of about 40 to 60 minutes from 10 weeks of age until photo stimulation. This provides enough time for equal access to feed. If cleanup time is less than 30 minutes, increase feed volume and prolong cleanup time by applying an alternative feeding program such as 5/2 or 4/3 (see page 39). In the production period, hen cleanup time is one of the indicators used to determine the first feed decrease after peak production.

Key dictators of cleanup time are feed texture and size. In rearing and production, we recommend a crumble to prolong feed consumption time. Some producers may use mash coarse feed, which increases consumption time compared to a crumble. We discourage using pelleted feed in rearing or production since it can be consumed quickly and there may not be enough volume to guarantee equal distribution.

Factors affecting feed cleanup time:

1. Feeding program used in rearing
2. Physical form (pellets/crumble/mash)
3. Raw materials
4. Climate and daily temperature fluctuations
5. Drinking system (shortage of water)
6. Feeding system and speed of feed delivery
7. Flock health (sick birds will eat less or not at all)

Consistent timing of feed delivery is important for the flock and welfare and is as important as 'when the birds eat' (i.e. time of the day) and 'how often birds eat' (i.e. feeding program). Birds will learn when to expect food and will adjust accordingly. Irregular feeding schedules or a disruption in the normal feed routine can be very stressful for the flock. Consistent feeding times are necessary for bird health and good welfare outcomes. When transitioning from one feeding program to another, observe flock behavior, cleanup time, and activity level and strive to keep the time point of feeding the same.

Feed consumption times at two different ages with three feed form presentations



Age	General notes	Coarse Feed	Crumble	Pellet
0 to 3 weeks	Reduces to < 4 hours between 2 and 3 weeks	3 hours	2.5 hours	2 hours
8 weeks	Goal is > 45 minutes	75 minutes (5/2 program)	60 minutes (5/2 program)	<i>Pellets are not recommended in rearing</i>
16 weeks	Goal is > 30 minutes	50 minutes (5/2 program)	40 minutes (5/2 program)	
21 to 25 weeks	Daily feeding	30 minutes	15 to 30 minutes	<15 minutes <i>(Pellets are not recommended)</i>
30 weeks	Daily feeding	3 hours	2 hours	1 to 1 1/2 hours

The importance of nutrition

The correct feed formulation and nutritional content is required so that breeders express their genetic potential and produce fertile hatching eggs. Furthermore, high quality ingredients must be used to ensure the hatching eggs are free of contaminants and contain all the nutrients needed for hatching healthy broiler chicks.

The correct feed specifications are a very important factor in rearing and production for high performing flocks. Nutrition plays a key role in preparing pullets for production. Good rearing management with high uniformity and bodyweights on standard will not guarantee good production if the pullets are not conditioned properly due to inferior feed specifications. Consistent results will always be a challenge if the feed is not up to specifications. The feed specifications need to be integrated into the management methods to understand why and how the pullets grow, develop, feather and prepare for photo stimulation. Always purchase good quality feed ingredients and formulate diets based on the Cobb specifications available in our supplements (<http://Cobb-Vantress.com/resources>).

A standard feeding profile should be followed during rearing to keep bodyweights on the standard curve. Any small deviations from standard in bodyweight can be adjusted with small 1 to 2 g feed increments. Once established, use the feeding program as a general guide during rearing. Bodyweight can fluctuate within +/-2 % of the standard.

For consistent performance, prevent changes in feed formulation and monitor each feed delivery. Report any problems immediately. Feed samples should be stored on the farm for testing if necessary.

Key points for feed formulation and nutrition

- ✓ Collect samples of feed and write detailed notes (date mixed, date received, feed type (starter, breeder 1, etc.)) on the sampling container.
- ✓ Conduct regular audits that include sampling and testing of ingredient suppliers and the feed mill.

Feed Issues, Causes, and Possible Solutions

Common Issues	Common Causes	Possible Solutions
Incorrect formulation based on kcal (Mj) values	Feed formulation kcal (Mj) values include energy from feed additives (enzymes).	Do not include energy liberated from feed additives. This can result in kcal (Mj) values that are too low.
	Nutrient matrix for raw materials not accurate.	Evaluate and update nutrient values for each raw material in the diet on a regular basis.
Vitamin / mineral deficiency	Incorrect feed mixing or formulation	Test feed as formulations and actual percentages in feed may be different from what the feed mill reports.
		Possible mixing issues.
Decreased feed intake	Palatability	Check sodium source addition in feed and quality of fat sources. Test feed as formulations and actual percentages in feed may be different from what the feed mill reports. Possible mixing issues.
	Mycotoxins	Test feed for mycotoxins and contaminants.

- ✓ Carefully choose feed enzymes and match them with local raw materials as enzymes impact substrates available for microbial fermentation in the bird.
- ✓ Use the Cobb feed specifications and be sure to change feeds at the correct flock age (see next page for descriptions of each feed formulation).

Feed types by formulation based on age and their functions

Feed	Age	Function
Starter	0 to 4 weeks	This feed is designed to achieve the bodyweight standards and skeletal structure of the bird. With the low feed intake capacity the first week, higher density feeds (2850 energy kcal/kg (11.88 Mj/kg), 19 % crude protein and 0.93 % dig. Lysine) are recommended to achieve desired nutrient intake. It is recommended to present this feed as a crumble.
Grower	5 to 15 weeks	This feed can be very flexible based on the feeding program and is intended to help maintain and achieve small weight gains. Flocks with the current nutrient feeds are normally fed using an alternative feeding program. If an everyday program is required, adjust feed to provide more volume with good fiber ingredients for lower levels of energy and amino acids. Energy 2700 kcal/kg, (11.25 Mj/kg), 14.5 % protein and 0.60 dig. Lysine is formulated based on research and best flock performance.
Developer	16 weeks to 1st egg	The energy of this feed is intended to help deposit fat and protein giving the bird reserved energy to reduce the stress of photo stimulation, improve onset of lay, and, most importantly, for persistency of lay after 40 weeks. It is important to transition to this feed at 16 weeks and recommended to use this feed until 1st egg or 5 % production. Energy 2800 kcal/kg, (11.67 Mj/kg), protein 15 % and dig. Lysine 0.63 % are recommended. Calcium is increased from 0.95 to 1.20% to support storage of calcium. Some growers skip this feed (Cobb does not recommend this) for practical issues and keep feeding the lower density feed when the purpose of this stage is to prepare the pullet for photo stimulation.
Breeder 1	1st egg to 38 weeks	This feed is intended to help bird maintenance, bodyweight increase, and energy for egg production while feed amount is increased toward peak production. Transition from Developer to Breeder 1 feed by 1st egg in the flock and no later than the 3 to 5% daily egg production. Any further delay in Breeder 1 consumption will deplete bone calcium reserves in "early maturing" hens. This in turn could lead to increased hen mortality and is a commonly seen issue in flocks. Energy 2800 kcal/kg, (11.67 Mj/kg), protein 15 %, dig. Lysine 0.63 %, and Ca increases from 1.2 to 3 % to support egg production.
Breeder 2	38 weeks +	Breeder 2 has lower amino acid levels than Breeder 1 but the same amount of energy, as an extreme withdrawal of energy can affect production. This may occur during the normal practice of post peak feed reduction which is done to control excess bodyweight gain. Experience and research with lower energy in this phase has shown loss of feathers and drop in production. Calcium also increases to 3.2 % to prevent calcium depletion associated with a reduction of feed intake and maintain eggshell quality. Introducing Breeder 2 feed when egg weight is at 60 g for fast feather and 62 g for slow feather females can be an efficient way to control bodyweight and egg weight.
Male Feed	24 weeks +	The male feed has less energy and amino acids than other feeds, 2700 kcal/kg, (11.25 Mj/kg), protein 13 %, and dig. Lysine 0.50 %, providing more volume to males to maintain uniformity of weight and condition during mating. The males are more efficient at converting feed than females, so a bulky feed is needed. Any deficiency of vitamins and minerals can cause issues due to the low feed intake.

4.1 Phase 1 - Brooding (0 to 4 weeks)

Early feed management

The purpose of the brooding phase is to condition the chicks to manage growth. The parent stock broiler breeder originates from populations selected for desirable broiler traits that include average daily gain (ADG) and feed conversion (FCR) both of which are negatively associated with reproductive efficiency. In order to address this propensity to grow, birds must be managed to a defined growth curve established by Cobb. This growth curve varies based on breed and sex.

Average bodyweight is an important metric and deviation from the standard can be caused by low water and / or feed consumption (see right). Flock uniformity is another important metric critical for developing a flock that will consistently respond to feed changes at later ages.

Controlled feeding

Controlled feeding is necessary to prevent birds from exceeding the bodyweight standard. This is especially important for females from 4 weeks of age to the end of the rearing period. Following the recommended bodyweight standards during the first 4 weeks is important for frame size and uniformity development for males and females.

During the first month of growth the chick experiences rapid development of organs that support the healthy maturation of the breeder hen. Organs include those associated with neurological, immune, gastrointestinal, cardiovascular, pulmonary and skeletal systems. Prevent extended time periods below bodyweight standard which will compromise the normal development of the organs and lead to issues later in the life of the flock.

Over or under bodyweight standards are detrimental to mature breeder performance. Controlled feeding is therefore recommended immediately after placement. Ad-libitum feeding is not recommended during the first week because it is difficult to determine feed amounts that the flock consumed and can waste feed.

Preventing feed wastage in the litter is important so that birds will not eat this feed at a later age and gain weight unexpectedly. Instead, use specific amounts of feed with small incremental changes each day during the first week as shown in the table (right). By feeding a designated amount of feed each day, the bodyweight of the females and males should be on target by 4 weeks of age.

- ✓ Female feed can be set at 29 g from day 8 to 14.
- ✓ Male feed can be set at 32 g from day 8 to 14.

Troubleshooting early weight gain and uniformity issues

Primary reason for low early weight gain issue is low water consumption:

- ✓ Water temperature too hot
- ✓ Water line too high
- ✓ Wrong nipples for starting chicks (must be 360 degree)
- ✓ Water pressure too high
- ✓ Nipple pins stuck or clogged with debris
- ✓ Dirty water (insufficient flushing of water lines)

Secondary reason for low early weight gain issue is low feed consumption:

- ✓ Conduct crop checks
- ✓ Evaluate feed condition, quality and form (crumble or micro pellet)
- ✓ Check feed availability - feeder space and access

Example of feed intake per bird in the 1st week (males and females)

day	1	2	3	4	5	6	7	average
grams per day	12	15	19	24	26	28	29	22

- ✓ Daily feed allocation should be based on experience and managing weights to achieve Cobb standard bodyweight at 14 days.

Feeder space recommendations

Beginning at placement, a progressive feed space plan can be used to configure the system for the correct number of birds per pan or chain length at different ages, and to obtain good feed and bird distribution. Feeder space increases should be gradual and based on bird age and the amount of feed needed to cover the entire feed track. See tables on the preceding page for feed space requirements based on flock age and sex.

It is typical for houses to have up to 4 chain feeder loops, however, because of the volume of feed being delivered in relation to bird age use the following recommendations. Distribute the daily feed allocation across 2 loops from 0 to 5 weeks of age. Extend the feeding track to 3 loops from 5 to 11 weeks and all 4 loops from 12 to 20 weeks.

Feeder space calculations are based upon the average length and width of a full grown female, 30 and 15 cm, respectively. Using a chain feeder as an example, 1.5 meters will accommodate 10 birds on one side of the feeder. With a pan or oval feeder, the widest part of the bird is actually 10 cm away from the feeder ($(30 \text{ cm} + (10 \text{ cm} \times 2)) = 50 \text{ cm}$; see diagram below). Therefore, to determine the feeding space, calculate the circumference of the actual feeding circle using the formula $2\pi r = (2 \times \pi \times 25) = 157 \text{ cm}$.

For feeder space between lines, a minimum of 60 cm is required, which is the length of 2 birds tail to tail. However, there is no room for birds to pass between the feeders. Therefore, by placing feeders 75 cm apart, one bird can pass and by placing feeders 90 cm apart, two birds going in opposite directions can pass between the feed lines.

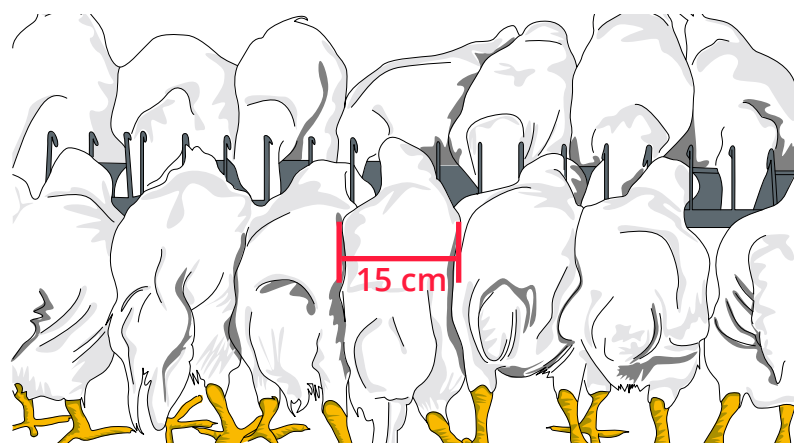

90 cm of feeder space (per side) shown

Chain feeder space is calculated based on the widest part of the full grown hen (15 cm). Divide the linear length of the chain feeder in cm by 15 to determine the number of birds each side of the chain feeder can accommodate.

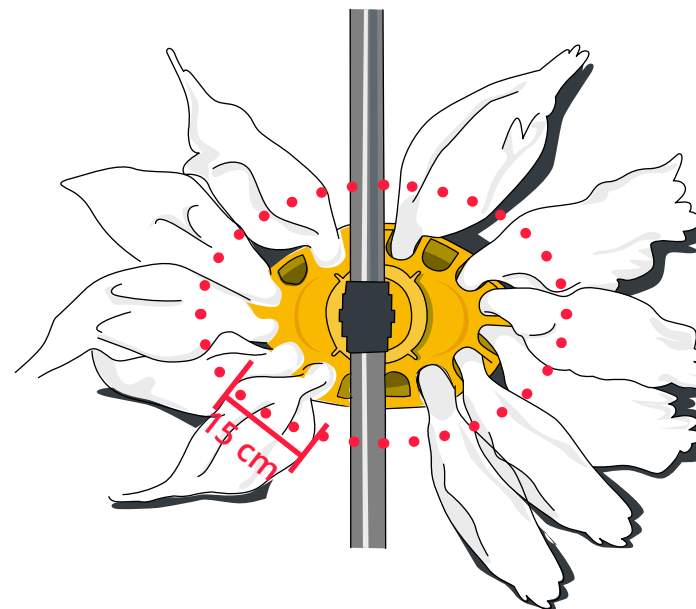

Oval and pan feeder space is calculated based on the widest part of the full grown hen (15 cm). Use the actual feeding circle (red dotted line) to calculate the linear space available for the birds.

Recommended progressive feeder space for Cobb females in rearing

Age (weeks)	Chain Feeder Space per Bird		Round Pan (30 cm (11.8 in) diameter)* Birds per Pan	Oval Pan Birds per Pan	Manual Tubular (30 cm (11.8 in) diameter)* Birds per Pan
	cm	in			
0 to 4	5	1.90	20 to 25	23 to 28	20 to 25
5 to 8	9	3.54	16 to 18	18 to 20	16 to 18
9 to 12	13	5.12	14 to 16	16 to 18	14 to 16
13 to 21	15	5.90	10 to 12	13 to 14	10 to 12

Recommended progressive feeder space for Cobb males in rearing

Age (weeks)	Chain Feeder Space per bird		Round pan (30 cm (11.8 in) diameter)* birds per Pan	Oval pan birds per pan	Manual Tubular (30 cm (11.8 in) diameter)* birds per pan
	cm	in			
0 to 4	6	2.36	20 to 23	23 to 25	20 to 23
5 to 8	10	3.94	14 to 16	16 to 18	14 to 16
9 to 12	14	5.51	12 to 14	14 to 16	12 to 14
13 to 21	18	7.08	8 to 10	10 to 12	8 to 10

Recommended minimum feeder space for Cobb males and females in production

Sex	Age (weeks)	Chain Feeder Space per Bird		Round Pan (30 cm (11.8 in) diameter)* Birds per Pan	Oval Pan Birds per Pan	Manual Tubular (30 cm (11.8 in) diameter)* Birds per Pan
		cm	in			
Female	22 to 65	15	5.90	10 to 12	13 to 15	10 to 12
Male	22 to 65	20	7.87	8 to 10	10 to 12	8 to 10

* Calculation based on diameter and circumference of pan. If your feeder pan has a different diameter, please check with Cobb technical representative for feeder space calculation. Make sure you are using feeders specifically designed for males.

Inexpensive methods for improving feed distribution

- ✓ Supplemental hoppers can be added to the system to increase points of feed distribution.
- ✓ Additional lines of feeders or loops in the chain system can be added.
- ✓ Condition the birds to associate feed a specific signal such as signal lighting or the sound of the feeder. This process will allow birds to spread out with enough access to the feeder. For example, turning off the lights prior to and during feed distribution will train the birds to expect feeding after this signal. Entering the house after distribution in the dark will not trigger a lot of movement of the birds and reduce stress.



Supplemental hoppers can be added to the system to increase points of feed distribution.

Monitoring bodyweights and uniformity

Establishing flock uniformity requires the collection of accurate weight data using consistent sampling methods. The goal is to weigh enough birds to accurately represent average bodyweight of the flock. Birds should be individually weighed at placement and 7 and 14 days. To expedite chick placement, chicks can be bulk weighed. If bulk weighing, use a platform electronic scale with enough surface space to weigh a group of 5 to 10 chicks. Keep group size consistent to prevent miscounting the chicks. It is important that no less than 2 % of the flock be weighed in order to correctly estimate average bodyweight and calculate flock uniformity.

Once the flock reaches 3 weeks of age, it is recommended to increase the sample size to 3 to 5 % of the population. Weigh birds from three different locations (front, middle, back) of each house to make the sample more representative of the flock.

To increase accuracy of the sampling, use a catching pen, do not randomly pick up and weigh birds, and do not force birds into the pen. Forcing birds into the pen or selectively catching birds and placing them in a pen can result in a non-representative flock sample for weighing. Instead, the catch frame should be placed to allow the birds to freely enter the pen for a more representative sample of the flock. Weigh every bird individually inside the catch pen, including small birds, and do not reject any weights, except for sexing errors. After each bird is weighed, release the bird into the house. Continue weighing until the pen is empty. Record each weight and calculate the average weight as well as the flock weight distribution. (See Chapters 8 and 9 for more information on weighing, uniformity and grading).



Key Point

Even feed distribution and management of the feeding equipment along with uniform intake of feed are considered the most important objectives in rearing and production. Regardless of the type of feeding system used, feed should be distributed to all birds throughout the house in less than 3 minutes to eliminate stress and piling of birds during feeding. A quick distribution will also result in improved flock uniformity. Feed must be available for all birds at the same time. Feeder space per bird is calculated based on the assumption that all parts of the feed line have equivalent amounts of feed after the feed has been distributed.

4.2 Phase 2 - Rearing (4 to 8 weeks)

The brooding phase is focused on getting the chicks started and adapting them to controlled feeding. In the maintenance phase, the primary objectives are weight and fleshing control. It is important throughout this phase to regularly handle the birds to evaluate their fleshing scores. By handling the birds regularly and at different ages, their development and body condition will be better understood. Bird condition at photo stimulation is critical. The only way to achieve the desired bird condition is with correct weight control and regular evaluation of body condition or fleshing. The support systems continue to develop and it is important to not fall below bodyweight standard for extended periods of time.

If the males do not achieve target bodyweight during the first 4 weeks, a slight increase in feed amount is recommended. Alternatively, light hours can be increased to allow the males to consume any remaining feed in the feeding system.

Feeding methods for optimal rearing management

Feed allocation programs are used during the rearing phase to help control the growth, weight gain, and maturation of breeding flocks. **Be aware of any national legislation that must be considered when designing and implementing a feeding program for the rearing period.** Feed allocation may consist of daily feeding (with restricted amounts per bird per day) or alternate day feeding (with larger amounts per bird on days when feed is provided). The following are examples of feeding programs:

Breeder Feeding Programs

Week	Feed Day	Every Day	6/1	5/2	4/3	Skip-a-day
6	Sunday	on	on	on	on	on
	Monday	on	on	on	off	off
	Tuesday	on	off	off	on	on
	Wednesday	on	on	on	off	off
	Thursday	on	on	on	on	on
	Friday	on	on	on	off	off
	Saturday	on	on	off	on	on
7	Sunday	on	on	on	on	off
	Monday	on	on	on	off	on
	Tuesday	on	off	off	on	off
	Wednesday	on	on	on	off	on
	Thursday	on	on	on	on	off
	Friday	on	on	on	off	on
	Saturday	on	on	off	on	off

Every Day - Birds are fed every day.

5/2 - Birds are fed 3 consecutive days followed by 1 day off; then 2 days of feeding followed by 1 day off to complete the 7-day cycle. Note: This is the most common feeding program globally.

4/3 - Birds are fed 4 non-consecutive days per week and off-feed for 3 non-consecutive days (see chart to left).

Skip-a-day - Birds are fed every other day.

6/1 - 6 days with feed and 1 day off.

To the left, is an example of a feeding schedule for each feeding program over weeks 6 and 7. On and off days for each breeder feeding program are set by the producer with consideration of the on-farm activities. Never use a feeding program with 2 consecutive off days. Birds on "off" days either receive scratch or no feed.



Animal Welfare Tips

For a good net welfare benefit (controlled growth and maturity, optimal uniformity, and long-term flock livability), feed allocation programs are commonly used in breeding programs around the world. Innovative research has recently shown that rearing flocks can benefit by having a scratch-diet or 'filler-diet' (low-density, low-calorie food substrate like soyhulls) on the traditional off-fed days. The benefits of this filler-diet are that birds are calmer, have better uniformity, and have better gastrointestinal integrity since there is no extended lapse in food.

Breeder Feeding Programs

Every day feeding

In some countries the local welfare conditions require the birds to be fed daily. This feeding method provides a daily allocation designed to manage growth, sexual maturity and into production.

Benefits

- ✓ Normalized feeding pattern and better FCR (better feed absorption in the intestinal tract).
- ✓ Calm flock with normal behavior and few enteric challenges.
- ✓ Diluted feed allows increased daily feed allocation and therefore improved feed distribution. With dilution, the feed increases are around +3 g /female/week between 5 to 13 weeks of age, and this keeps the flock growing more controlled and prevents “frog feeding” (changing of weekly feed amounts up and down based on bodyweight fluctuations).
- ✓ More easily done when mash feeds are being used that take more time to be consumed.
- ✓ Caretakers interact with the flocks daily as part of the normal feeding schedule.

Challenges

- ✓ Feed distribution needs to be ideal and feed needs to go around completely to guarantee enough feeder space per bird.
- ✓ Dilution of the feed is necessary for feed distribution, which increases the total feed used in rearing and feed cost (more milling, transport and storage).
- ✓ Uniformity is often more difficult to maintain, especially after 12 weeks of age due to very fast feed cleanup times.
- ✓ Birds have smaller crops and gizzards because of reduced feed amounts as compared to other feeding programs.
- ✓ Personnel must be present at specific times to check feed and water availability.
- ✓ On days of individual bird vaccinations feed is delivered later than the scheduled time. Vaccination crews need to finish by noon or early afternoon to give enough time afterwards for feeding and water intake. The light program may need to be extended on vaccination days.

6/1 program

This feeding program is typically used as a bridge or intermediate step to progress to a 5/2 or skip-a-day program. Similarly, it can be used to return to daily feeding at the end of the rearing period. This program is usually introduced in the 3rd week for 1 week prior to the 5/2 or skip-a-day program. Likewise, the 6/1 program is also used at the end of rearing (18 to 20 weeks) for a 1 to 2 week period depending on how fast birds consume the feed and if there are feed distribution issues.

Breeder Feeding Programs (Cont.)

5/2 program

This is the most commonly used program in rearing worldwide and serves as a compromise between daily feeding and skip-a-day feeding. It is used primarily to maintain or enhance good feed distribution and uniformity. Typically, this program is used during the late part of the growing period, particularly if “feed impaction” (choking) is an issue on feed days when the 4/3 or skip-a-day feeding program is used.

Benefits

- ✓ Birds are fed on the same days each week throughout the rearing period.
- ✓ This program increases the feed amounts presented to the birds on feeding day compared to a 6/1 or everyday feeding program.
- ✓ Good feed distribution over the whole house area with pans and chains.
- ✓ May be implemented at 3 to 4 weeks of age and continued until 16 weeks of age.
- ✓ Can be extended to 1st egg when feed amounts are small (for example 100 g per pullet at start of production).
- ✓ Used with medium to high energy feeds that are fed at lower feed amounts.
- ✓ Can use the non-feeding days to apply vaccinations and “off” feed days can fall on Sunday to create a day with reduced labor.

Challenges

- ✓ Visits should be minimized on non-feeding days and only essential staff should conduct checks. Visiting the flock on non-feeding days can make the flock agitated.
- ✓ Visits should be done on non-feeding days only if vaccinations are done.
- ✓ Feeding program is not consistent during the week since there will be a period of 3 ‘on-feed’ days followed by an off-feed day and then 2 ‘on-feed’ days followed by an off-feed day.
- ✓ Flocks display more stress related behaviors on the non-feeding days.

4/3 program and Skip-a-day

These programs are preferred when feeding low volumes of a high-density feed (>2900 kcal/kg; (12.08 MJ/kg)), or when feeding space is limited. It ensures a longer feed period and allows timid birds to receive enough feed. From 21 or 28 days to 140 days, the equivalent of 2 days feed is given on a single day, with only a scratch feed provided the next day. If low feed amounts can be given then it is basically an on and off day feeding. This means that with skip-a-day the feed amount will double (100 % more) on feeding day. With the 4/3 program the feed amount is increased by 75 % on a feeding day. This program is used when feed presentation is a pellet or crumble.

Benefits

- ✓ Improves uniformity as a larger feed amount is being distributed over the entire house.
- ✓ More common where there is a shortage of feeder space.
- ✓ Feed mill can produce less feed and less feed is being transported to the farms reducing transport costs.
- ✓ Feed mill has more capacity to cover all the farms (If the feed mill is at full capacity it becomes the bottleneck in the integration).
- ✓ Crops and gizzards are larger for birds trained to consume larger amounts of feed. This means that feed cleanup time in production is also faster. This can be an advantage with hot weather conditions.

Challenges

- ✓ Flocks display more stress related behaviors on the non-feeding days.
- ✓ Cannot feed more on a feeding day than is being fed in peak production (for example 165 g in peak production means with skip-a-day a feed amount of 82.5 g per day). That amount is being fed at around 19 to 20 weeks of age. At that time frame a change must be done to 4/3 or 5/2 program for a few weeks and then change to daily feeding.
- ✓ Over consumption is a risk for the flock if the feed amount on a feeding day is too high leading to overeating, pendulous crops and even death. If feed shock occurs, change the feeding program to 5/2 program.

Calculating Feed Allocations for Feeding Programs

Example calculations for each feeding program using the female daily feed allowance for week 6 is 47 g/bird/day and for week 7 is 49 g/bird/day.

Example calculations for each feeding program using the female daily feed allowance for week 6 is 10.4 lb/100 pullets/day and for week 7 is 10.8 lb/100 pullets/day

Every Day Feeding

Week 6 = 47 g/pullet/day
Week 7 = 49 g/pullet/day

Week 6 = 10.4 lb/100 pullets/day
Week 7 = 10.8 lb/100 pullets/day

6/1 Feeding

Week 6 = (47 g X 7 day) /6 feed days = 54.8 g/pullet/feed day
Week 7 = (49 g X 7 day) /6 feed days = 57.2 g/pullet/feed day

Week 6 = (10.4 lb/100 pullets/day X 7 day) /6 feed days = 12.1 lb/100 pullets/feed day
Week 7 = (10.8 lb/100 pullets/day X 7 day) /6 feed days = 12.6 lb/100 pullets/feed day

5/2 Feeding

Week 6 = (47 g X 7 day) /5 feed days = 65.8 g/pullet/feed day
Week 7 = (49 g X 7 day) /5 feed days = 68.6 g/pullet/feed day

Week 6 = (10.4 lb/100 pullets/day X 7 day) /5 feed days = 14.6 lb/100 pullets/feed day
Week 7 = (10.8 lb/100 pullets/day X 7 day) /5 feed days = 15.1 lb/100 pullets/feed day

4/3 Feeding

Week 6 = (47 g X 7 day) /4 feed days = 82.3 g/pullet/feed day
Week 7 = (49 g X 7 day) /4 feed days = 85.8 g/pullet/feed day

Week 6 = (10.4 lb/100 pullets/day X 7 day) /4 feed days = 18.2 lb/100 pullets/feed day
Week 7 = (10.8 lb/100 pullets/day X 7 day) /4 feed days = 18.9 lb/100 pullets/feed day

Skip-a-day

Week 6 = (47 g X 7 day) /4 feed days = 82.3 g/pullet/feed day
Week 7 = (49 g X 7 day) /3 feed days = 114.3 g/pullet/feed day

Week 6 = (10.4 lb/100 pullets/day X 7 day) /4 feed days = 18.2 lb/100 pullets/feed day
Week 7 = (10.8 lb/100 pullets/day X 7 day) /3 feed days = 25.2 lb/100 pullets/feed day

Note: When using a skip-a-day feed program never exceed the anticipated "peak feed amount" at any time. For example, if the skip-a-day amount approaches 154 g/bird (34 lb/100 birds) or equivalent of a daily feed amount of 77 g/bird (17 lb/100 birds), the flock should be carefully monitored for signs of feed impaction (feed shock). If this situation is encountered, consider switching to a 4/3 or 5/2 feed program which will provide extra feed days to reduce the calculated per feed day consumption. These calculations can be applied to male feeding programs.

Breeder feeding programs case study

Issue:

There is a significant drop in feed cleanup time when using an everyday feeding program. Rapid feed cleanup times will hurt uniformity and make the birds more nervous since the more timid birds may not be able to eat or may not have much to eat. A crop check immediately after feed cleanup will indicate if there is a feed intake uniformity issue. A maximum of 2 % of the birds should have a small amount of feed in the crop.

Solution:

Introduce a 6/1 program for 1 week and at 4 weeks (28 days), introduce a 5/2 program until 18 to 19 weeks. After 19 weeks, return to daily feeding. It is possible to continue with a 5/2 or 6/1 feeding program until the week of photo stimulation when feed amounts are very low or the birds are fed pelleted rations with feed cleanup times of less than 30 minutes.

Transitioning from daily feeding to an alternative feeding program normally starts when the feed cleanup time is less than 4 hours, typically between 14 to 18 days of age or into the third week. When shifting between alternative feeding programs, for example, shifting from 4/3 to 5/2, it is important to observe bird behavior and health. A shift from a lower feed amount to a higher feed amount on feed day can lead to impaction. Providing the flock with an opportunity to drink 30 to 40 minutes before feeding can add moisture to consumed feed. If impacted crops are noticed, crop checks after feeding can help the farm team members understand the bird's condition after eating.

4.3 Phase 3 - Maintenance (8 to 12 weeks)

In the rearing phase (4 to 8 weeks), management focused on achieving the Cobb recommended bodyweight standards and uniformity targets. Management from 8 to 12 weeks continues to focus on meeting bodyweight and uniformity standards, but also maintaining frame size. This period has the lowest weekly feed increases of the rearing period varying from an increase of 1 to 3 g per week for females. Please refer to Chapter 8 to manage bodyweight back to standard if flock is above or below curve.



Animal Welfare Tips

To optimize feed digestion, bird health and to reduce risk of feed shock, lights can be turned on and birds can be encouraged to drink during the first 15 to 30 minutes of the "on-feed" days. This short period will also enable the farmer to walk the flock to check for mortality, to evaluate any birds that may need to be culled, and to verify that the house environment and equipment are in acceptable condition. Then, lights can be turned off to allow the feed to be quickly and efficiently distributed in the dark. This plan will help optimize bird behavior and distribution for feeding when the lights are turned on again, and will enable the farmer to fix any equipment problems before feed distribution occurs. Regardless of the feeding program used, an evaluation of gradual weight gain, body composition, and uniformity should be used throughout the rearing period to optimize welfare outcomes of the breeder flock.

4.4 Phase 4 - Controlled Growth (12 to 16 weeks)

Emphasis transitions from bodyweight to fleshing scores during this phase. The skeletal frame is essentially 90 % complete by 12 weeks so nutritional resources will be allocated towards fleshing. At this point, the flock should increase from fleshing scores of 2 to scores of 3. In addition, as the birds continue to grow, pressure on feed and water delivery systems will increase. It is critical that correct feed and drinker space is provided at all phases of growout.

The table (right) shows the fleshing objectives for females at different ages from 12 through 22 weeks of age. At 12 weeks of age, puberty starts, and females need to be on fleshing target to achieve the fleshing objectives at subsequent ages. The table is only a guide but indicates the importance of regular fleshing and the importance of beginning the fleshing evaluation at 12 weeks of age to ensure progress and ideal development of the breast muscle.

The fleshing evaluations can be combined with pullet weights at these specific ages. As shown in the table, most of the females at 12 weeks of age have a fleshing score of 2. The percentage of pullets with a score of 2 is constantly reduced over the life of flock and, ideally, should be zero at photo stimulation.

Achieving the early fleshing targets between 12 and 16 weeks will promote pelvic or abdominal fat deposition that the females require at photo stimulation. If these targets are not achieved, it will be very difficult to correct the fleshing condition, female body composition, or the flock uniformity at later ages.

- ✓ At 12 weeks of age, the feed management decisions should move away from bodyweight and towards interpretation of flock fleshing scores.
- ✓ Having all team members concur on the fleshing scores and flock development will help the production team make critical decisions for future management including feeding, lighting, transfer age, etc.
- ✓ Condition or uniformity cannot be corrected past 20 weeks of age.
- ✓ At photo stimulation the female's body composition is as important as the bird's bodyweight - the pullet must have adequate fat reserve and fleshing at this point. Birds easily accumulate fleshing between 16 and 20 weeks of age. However, this is not the case with building fat reserve; at 17 weeks of age, pullets start depositing abdominal fat.

Goals for flock percentage (females only) with fleshing score and pelvic fat based on flock age

Age (weeks)	Fleshing Score			Total #3 + #4 (%)	Pelvic fat (%)
	Score 2 (%)	Score 3 (%)	Score 4 (%)		
12	70	30	0	30	0
16	40	60	0	60	0
19	<10	60	30	90	>65
20	<5	60	35	95	>75
21	0	60	40	100	>85
22	0	60	40	100	>90

Explanation of female fleshing scores

FLESHING 1

Substantially under the desired level of fleshing - very thin birds. Birds with this degree of fleshing need to be evaluated for culling.



FLESHING 2

Ideal breast shape at 12 weeks of age and the lowest fleshing condition over the life of the bird.



FLESHING 3

Breast fleshing shape at 16 to 25 weeks during early preparation for lay



FLESHING 4

Breast fleshing shape at 19 to 25 weeks during preparation for lay.



FLESHING 5

Oversized breast muscle.



4.5 Phase 5 - Accelerated Growth (16 to 20 weeks)

In this phase, consistent weight gains are needed. This weight gain will allow the females to develop the desired fleshing and sexual uniformity to maximize peak egg production and maintain post peak persistency. Although consistent weight gain is important during this phase, pullet fleshing scores are more important. The objective of the accelerated growth phase is to provide enough fleshing and fat reserves to last the hen through peak production.

Body fat must be attained before photo stimulation to have:

- ✓ good sexual synchronization of the females
- ✓ high peak production and persistency
- ✓ high hatchability of eggs produced early in the production cycle
- ✓ good chick quality and vitality
- ✓ low mortality in females in the period leading up to peak production

Tips to achieve desired body condition

- ✓ A minimum female bodyweight increase of 36 % is needed from 16 weeks (112 days) to 20 weeks (140 days) when using the Cobb recommended feed specifications. To achieve this gain of 36 % in bodyweight, the feed must be increased a minimum of 42 % (or 6 % higher than the bodyweight increase) under normal conditions. Do not feed in this period based on bodyweight. Use a fixed feeding profile.
- ✓ Post 16 weeks, all females should move gradually towards fleshing #3, and at 21 weeks should be between #3 and #4 (see table on previous page).
- ✓ In some situations where females are delayed in conditioning, (fleshing and pelvic fat deposition) an increase of bodyweight of between 38 and 40 % is needed.
- ✓ Uniformity of frame, fleshing, pelvic fat and bodyweight determines to a great extent, the sexual uniformity of the flock, and hence the peak production performance and persistency.

Extremes in fleshing and fat deposition

A pullet with a fleshing score of 2 at 20 weeks of age will not normally have pelvic fat or presence of a fat vein deposition. Tissue maintenance and growth are a higher priority than initiation of puberty. Therefore, pullets with a fleshing score of 2 at 20 weeks will experience delayed sexual maturity. Although these pullets may sexually mature, they tend to have issues with production.



Animal Welfare Tips

To prepare the pullet for optimal health, welfare and performance results, we recommend achieving the desired body composition (fleshing and fat coverage) before photo stimulation occurs.

4.6 House Preparation for Transfer and Production

Housing and equipment requirements for community nesting systems

Slats

Well-designed slats are an integral part of preventing floor eggs. A ratio of 60 % floor area to 40 % slat area is normally used. With a 12 m (40 ft) wide houses, slats need to extend 2 m (6.5 ft) from the front of the nest on each side. With a 14 m (46 ft) wide houses, slats need to extend 2.7 m (8.8 ft) from the front of the nest on each side. Apply a slat slope of 7° with hardwood or plastic slats. Hardwood slats are preferred when starting with community nests because there tends to be very few slat eggs, females have improved grip to access the nests and are cleaner than plastic slats. Hardwood slats are also easier for the caretakers to cross when checking the nests for mortality, cleanness and whether eggs are rolling correctly onto the belts. Do not use mini-slats of 1.2 m (4 ft) wide that have only enough space for a single drinker line. This system can cause floor eggs and have very inconsistent results.

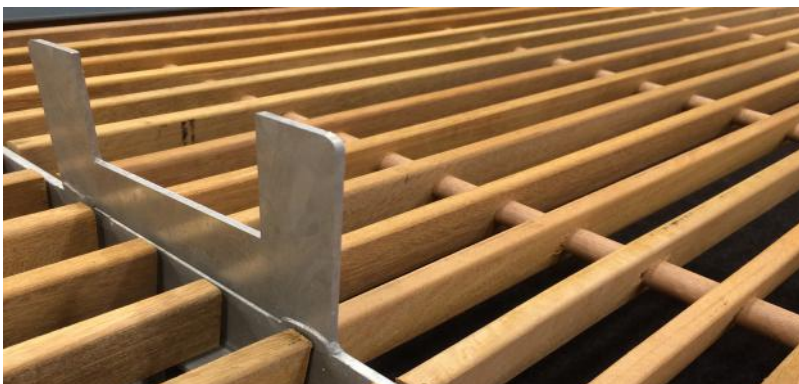

Wooden slats can help reduce the number of floor eggs when production begins.

Feeders

A minimum of a single line or loop of the female feeder lines should be on or suspended above the slats. For a 12 m (40 ft) wide house, place 1 feeder line on the slats. In a 14 m (46 ft) wide house, place 2 feeder lines on the slats. The distance from the slat stepup to the first feeder should be a minimum of 50 cm (20 in).

Drinkers

The nipple drinker line in front of the nest must be 60 to 70 cm (23 1/2 to 27 1/2 in) from the nest entrance. The distance between the water line and first feeder loop should be around 60 cm (23 1/2 in). Do not put water lines in the scratch area for females. Drinkers should be installed at a rate of 8 to 10 females per nipple or 1 bell drinker per 75 birds.

Lights

Lights should be placed just outside the slat area and just above the start of the litter (scratch) area, so that the slats do not cast a shadow over the scratch area. The scratch area should have uniform light distribution with high light intensity (minimum 50 to maximum 100 lux). The lights should be located to allow 2 to 4 lux to reach the back of the nest entrance. No extra lights inside or directly above the nest are needed.

Ventilation

With respect to ventilation, no air should go through the nest and cause draft which can be important when using cross-ventilation. In tropical or hot climates, a good cooling system is needed to prevent excessively high temperatures in the house and thus nests. Overheating in the house and nests will cause females to lay the eggs on the slats or scratch area. Always use roof insulation with minimum R12 for tropical climates and R20 for cold climates.



Animal Welfare Tips

Housing and equipment requirements for production systems



Slats should be 45 cm (18 in) high, measured from the top of the slats to the concrete floor.



Baskets or steps can be used to help birds access the slats.

Slat height is very important for welfare of the flock and for optimal performance outcomes. The recommended slat height (measured from the top of the slats to the concrete floor) is 45 cm (18 in). The 45 cm height is recommended because droppings that fall through the slats will accumulate over time. If the slats are too low, the droppings may start to touch the bottom of the slats or come through the slats. If this happens, the slats, nests, hen's feet, and eggs can become dirty and contaminated. For slats taller than 45 cm (not recommended) consider using steps, ramps or baskets placed along the slat edge to facilitate bird movement to and from the scratch area. Some slat designs have 2 height positions, one of 35 cm (14 in) used in the first part of the production period and then a second higher position of 45 cm used after 40 weeks of age. This concept is recommended for the Cobb females in community house setups (not US style house configuration that do not offer this feature).

A process audit for welfare is a good tool to use during the transfer process to verify that management, handling, bird care and biosecurity protocols are achieved. Examples of items to audit include: house preparation and setup (lighting, drinker and feeder equipment, slat condition, ventilation, etc.), bird condition and welfare quality, handling during the unloading process, calibration of feeding equipment, maintenance of transfer equipment, and bird behavior and distribution after transfer.

During house preparation and before receiving birds in the house, conduct a detailed audit to ensure that slats are set up correctly to optimize welfare outcomes. For example:

- ✓ Are slats in good condition (no cracked, broken or missing slats), secure (attached to the braces underneath), and positioned correctly (spacing is appropriate to prevent leg or foot entrapment)?
- ✓ Are the front and back boards securely attached to the slats to prevent bird entrapment and entry underneath the slats?
- ✓ Are slats aligned correctly to prevent gaps and unevenness?

Nesting systems

Manual nest systems

Manual nesting systems are still popular in regions of the world with lower labor costs. These systems should provide 1 nest for 4 hens. The nest boxes must have solid bottoms and be well-maintained so it is the most attractive place in the house for the birds to lay eggs. The nest should be bird friendly, have clean and dry bedding and provide environmental comfort for the hen. The ideal nest size is 25 cm (9 7/8 in) long, 30 cm (11 7/8 in) high and 25 cm (9 7/8 in) deep, so females feel protected. In addition, the instep should be at least a 15 cm (6 in) high. Fill the nests with material that is a minimum 1/2 to a maximum 2/3 of the instep height for the hen to make a concave nest. Overfilling the nests will make them less attractive and hens will kick out the expensive nest material. The maximum height to jump to the perches to get into the nest should be around 45 cm (18 in). Egg collection should be done frequently to prevent having more than 3 eggs per nest because this can induce pre-incubation and broken eggs.



Mechanical nest or automated egg collection

There is a strong movement to mechanize egg gathering worldwide. The egg collection in the house can be automated with individual or community nests.

Individual mechanical nest systems

- ✓ Very popular in the USA house setup with 2/3 slats and 1/3 scratch area in the center of the house.
- ✓ 1 line of mechanical nests on each of the slats or 2 lines of nests per house.
- ✓ The advantage of this design is a low percentage of floor or slat eggs.
- ✓ All the equipment is over the slats (feeders, drinkers and nest system).
- ✓ Female density is limited to a maximum of 5.5 females per m² (1.96 ft² per bird). At this maximum density, a shortage of feeder space can affect peak production and production persistency.

Community nest systems

- ✓ The industry worldwide is adopting the European community nest system.
- ✓ 1 line of automatic nests placed in the central part of the house with slats extending out from either side of the nests.
- ✓ Female stocking densities: 6 to 7 females per m² (1.54 to 1.80 ft² per bird).
- ✓ Higher female stocking densities significantly reduce hatching egg costs and pay for the higher investment costs due to higher financial return per square meter.
- ✓ If the house design and equipment configuration is correct the community nest system is highly efficient with a low percentage of floor and slat eggs.
- ✓ For a system to be successful, the nests must be very attractive to the females to prevent slat and floor eggs.



Key Point

There are very important house setup rules that need to be addressed to prevent problems with floor eggs which are the primary disadvantage of community nesting systems. See Chapter 12 on egg handling for troubleshooting floor eggs.

Community Nest Design

With community nest systems, there are generally 2 nest sizes (40 or 45 cm deep, by 240 cm long) with each nest unit having 4 entrance holes, (2 on each side). Use the recommendations on birds per nest hole from the manufacturer or use the guidelines to the right. Install a nest system that gives the lowest percentage of floor or slat eggs. Always use the larger nest dimensions when houses are 14 m or wider.

Most nest types in the market do not exceed 200 females per nest unit (nest unit of 2.4 m length with 83 hens per linear meter of house). This calculation is conservative and can be used when beginning an operation with community nests. There is always the possibility to increase the female density when the operation runs well and enough of experience has been obtained.

Example guidelines of hens per nest hole for Jansen and Van Gent nests*

40 cm deep nest - calculate maximum 230 females per nest unit (4 holes)

- * or 58 females per hole
- * or 96 females per linear meter of house length (48 females on each side of the nest per linear meter of house length)

45 cm deep nest - calculate maximum 260 females per nest unit (4 holes)

- * or 65 females per hole
- * or 108 females per linear meter of house length (54 females on each side of the nest per linear meter of house length)

*Manufacturers named here are for guideline purposes and should not be considered as an endorsement.



Female density in production

In a 12 m wide house install 3 chain feeder loops. This provides:

1200 cm of feeder space per meter house length ÷ 15 cm feeder space/hen = 80 hens per linear meter house length
80 hens per linear meter house length ÷ 12 m wide house = 6.7 hens/m².

For nest systems going from the front to the back of the house with only a cross over at both ends and one half-way in the house, the nesting space is adequate for 80 hens per linear meter.

In a 14 m wide house install 4 chain feeder loops, 2 on the slats and 2 in the litter area. This provides:

1600 cm of feeder space per linear meter house ÷ 15 cm feeder space per hen = 107 hens per linear meter house
107 hens per linear meter house ÷ 14 m wide house = 7.6 hens /m².

Normally density is limited to 7 hens / m² with good environmental conditions. When using only 3 feeder loops the density will become:

1200 cm of feeder space per linear m house ÷ 15 cm feeder space per hen = 80 hens per linear meter house
80 hens per linear meter house ÷ 14 m wide house = 5.7 hens /m².

Because density is low, it is better to install the 4th chain loop to have some flexibility with feeder space. Another option is to start out with 3 loops and 5.7 hens / m² and, later, expand to 7 hens /m². In this case, always install the first 2 feeder lines on the slats as it is easier to install an additional feeder loop in the scratch area when increasing from 3 to 4 feeder loops.

Increasing hen density can be very beneficial in terms of cost (see table to right). This is the most cost-effective way to increase the financial income per m² of house area and the cost of producing a hatching egg and chick.

When increasing the female density, equipment will also need to increase (feeder, drinker and nesting space). As mentioned earlier, a good tunnel ventilation system with pad cooling is very important to have the correct ambient temperatures and humidity to keep the birds comfortable and the litter or shavings in good conditions.

Cost reduction in hatching eggs based on increase in hen density

Females / m ²	Increase in density (%)	Cost reduction in hatching eggs (%)
5.5	100	100
6.0	109	-2.0
6.6	120	-4.5
7.0	127	-5.3



Animal Welfare Tips

Some countries have codes of practice that limit stocking density. When considering the density for rearing and production houses, verify the density expectations set by government and industry guidelines.

Community nesting systems designs

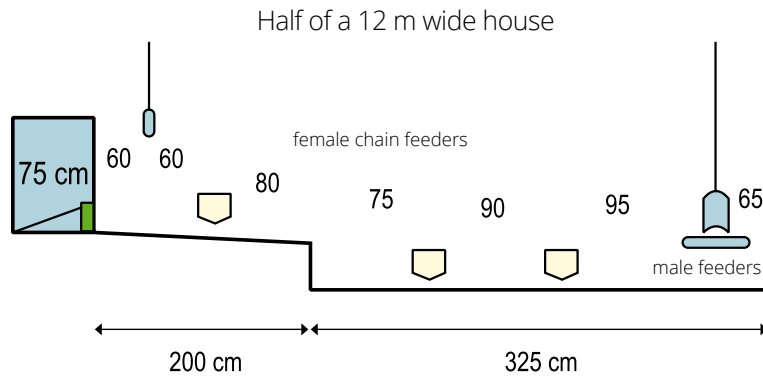

Slats should be 45 cm high (adjustable between 35 and 45 cm). For a 12 m wide house, the configuration has only 1 feeder line on the slats. There are 3 loops of chain feeders or 6 lines giving the potential density of 6.7 females per m^2 with 15 cm of feeder space per bird. Nipples are spaced 20 cm apart.

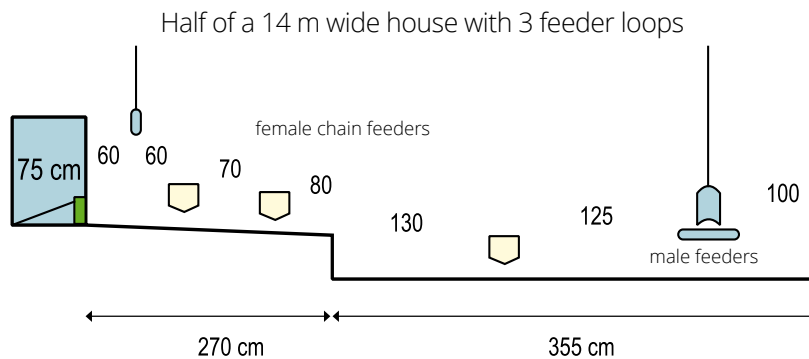

Slats should be 45 cm high (adjustable between 35 and 45 cm). Slat slope of 7 to 8 degrees. This configuration with 3 chain loops gives space for 5.7 females per m^2 with 15 cm of feeder space. With 2 chain loops on the slats, there is a lot of space in the litter area where there is only 1 chain loop. This keeps the litter in better condition than setups with 2 loops in the litter and provides more space for mating.

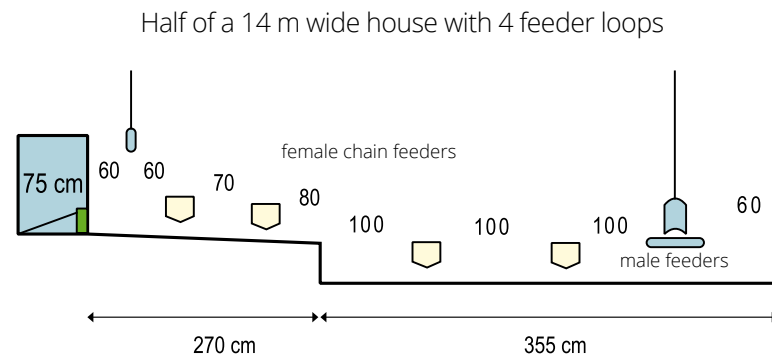

Slats should be 45 cm high (adjustable between 35 and 45 cm). With 4 feeder loops, there is feeder space for 7.6 females/ m^2 with 15 cm of feeder space per female. However, in most climates, the maximum of 7 females per m^2 is used. Higher densities are only recommended in cooler (temperate) climates and/or with good environmental controlled conditions (pad cooling and tunnel ventilation). With 4 chain loops, there is 16.3 cm of feeder space per female.



View the Cobb Basic Transfer Rules poster at <https://www.cobb-vantress.com/resource/posters>

4.7 Breeder Flock Transfer

Age for transferring stock to the production farms is determined mainly by the facilities available, bodyweight and the lighting program. The transfer can be a very stressful time for the birds. Plan the transfer in detail and handle the birds carefully. Prior to transfer, the rearing and laying managers should meet to discuss the flock. A copy of the rearing records should be transferred with the flock to the production farm and include:

- ✓ details of disease challenges, medication, and vaccination programs
- ✓ transfer bird numbers
- ✓ bodyweights as they relate to standard
- ✓ water consumption
- ✓ fleshing and pelvic fat scorings
- ✓ rearing lighting program and intensity
- ✓ feed amounts and times of feeding
- ✓ other relevant information to assist the production farm manager during the transition period

In some cases, it may be necessary to give additional feed several days before and/or after the birds have been transferred. The amount of extra feed and the time when it is given will depend on the season and the distance travelled. On the day of moving, birds should not be fed at the rearing farm to ensure that birds are empty (no feed in crops) to limit potential mortality, increased stress, and dirty crates.

When planning the transfer:

- ✓ The laying house must be ready to receive the flock, with the feeders, drinkers, and nest boxes fully operational, one week before the planned transfer date.
- ✓ Ensure that there are enough clean crates, coops or containers to move the whole flock.
- ✓ The final selection and transfer of the males should be done 2 to 3 days before females are transferred if sexual synchronization is optimal between the sexes.
- ✓ The females should be carefully observed and any birds that do not meet quality standards should be removed during transfer.
- ✓ Move the birds at night or in the early morning, especially in summer during hot weather.
- ✓ If using containers or coops with wheels, clear a path along the scratch area before removing the birds.
- ✓ Birds should have empty crops and digestive tracts prior to moving to reduce stress and keep the equipment cleaner.

Immediately post transfer:

- ✓ When taking birds out of crates or coops by hand, place them directly on the slats. If using modules with a loader or a pullet trailer to transfer birds to the laying house, birds should be placed on the litter since this process involves mechanical equipment. To prevent injury, never place birds directly on solid equipment (ex: feeder or nests).
- ✓ After arrival, provide feed in the tracks. Feed will provide a distraction, reduce stress, and help the birds become familiar with the new house. Depending on transportation and weather, feed amounts can be increased by 20 % for 2 to 3 days after the move.
- ✓ Observe the birds closely and perform crop checks to make sure that they have had access to feed and water.
- ✓ Walk through the house frequently to encourage birds to use the slatted area.
- ✓ Ideally, use the same drinker and feeder equipment styles in rearing and in production. However, if equipment is different carefully observe feeding the first 3 days after transfer to correct any issues.
- ✓ The flock will redistribute the shavings or straw the next day over the whole scratch area.



Key Point



Birds should not lose weight, condition or uniformity as a result of transfer. They must find feed and water quickly when they reach the production house.

4.8 Sexing Errors (Sex Slips)

Sexing parent stock chicks is done in the hatchery to separate the females and males. The females are used as parent stock and the males are usually used in broiler production. Sexing chicks can be challenging and some sex errors (sex slips) occur during the sexing process. However, these errors are not visible in the flock until 12 to 16 weeks of age as males will develop a comb earlier than females.

The sexing error percentage in the fast feathering parent stock, which are sexable by wing feathers, is normally between 0.3 % to 0.5 %. However, the slow feather cross must be sexed by the cloaca. This is more complicated and usually results in more sexing errors (between 1 to 1.5 %).

Leaving sexing errors in the flock will compromise the genetic potential of the offspring. It can also distort feather coloring and cause lower bodyweight as well as poor feed conversion, processing yield and uniformity in broiler flocks. For these reasons, it is important to eliminate all the sexing errors before 20 weeks of age.

Producers with good dark out rearing conditions and low light intensity (2 to 4 lux; 0.2 to 0.4 fc) may not recognize sexing errors easily. In this case, sexing errors can be detected and removed at 18 weeks of age during the individual vaccinations when the light intensity is high enough on the vaccination table to distinguish the sex errors. Any sex errors not detected during the vaccinations are usually clearly visible when moving females to the production house and can be removed at that time.

After transfer, it is important for a minimum of 2 people to walk through the flock before hatching eggs are collected to remove any remaining sexing errors from the flock (this is done when the flock is between 22 and 24 weeks of age). At this point, sexing errors can be recognized by examining the 4th and 5th toes (also called dewclaws) which are treated to condition the nails in males.



One way to identify sexing errors in males after transfer is to inspect the toes. Males that were sexed correctly should have their toes (dewclaws) conditioned to remove the nail (as shown in the photo). Any males without conditioned toes are most likely sexing errors and should be removed from the flock.



Animal Welfare Tips

Treatment of toes on day-old chicks has a net welfare benefit for the rooster and the breeder flock. The back toes of the male chick are treated to reduce the risk of scratching injuries that can occur in a breeder flock and to help prevent feather loss on the back of the hens during mating. Toe treatment will promote positive long-term health, welfare, and breeder performance outcomes for the flock.

4.9 Preparation for Photo Stimulation (20 to 24 weeks)

Ideally, at the start of photostimulation, the ratio of pullets with a fleshing score of 3 and 4 should be 60 and 40 % of the females respectively. The first photo stimulation should be between 147 and maximum 154 days of age. After first photo stimulation, use small feed increases of 2 to 4 g per female per week until the onset of production (around 5 % of production).

Physiological readiness for photo stimulation

The flock is prepared for photo stimulation when dry (before feeding) bodyweight is 2450 to 2600 g (5.40 to 5.73 lb) for fast feathering pullets and 2500 to 2600 g (5.51 to 5.73 lb) for slow feathering. In addition, 95 % of the pullets have a fleshing score of 3 or more and 85 % have pelvic fat.

A pullet in the correct condition will have a prominent fat deposition under the wing. Parallel to this fat deposit is a large blood vessel. This combination is often referred to as the fat vein. The fat vein can be used to determine subcutaneous fat deposition. However, pelvic fat is normally deposited earlier than the subcutaneous fat vein.



Elevated fat vein is in indication of good body fat reserves at 25 weeks.

The fat vein begins to appear in pullets around 21 weeks of age. Evaluation of the fat vein is most informative after 25 weeks of age, when production has started. At this point, the pelvic bones are no longer a good indicator of how much fat is being deposited in the abdominal cavity because they have widened considerably to allow for the passage of the eggs. Once the pelvic bones begin to separate, the pelvic space will widen after photo stimulation. This change should transition from a width of less than 1 finger for a pullet at 21 weeks old to a width of more than 2.5 to 3 fingers in fully producing hens. This is the primary reason why it is better to use the fat vein as an indicator of fat reserves after the females start production. It is always best to delay photo stimulation if the birds are not in the correct condition (body composition), as this will improve their performance, health and welfare during the laying phase.

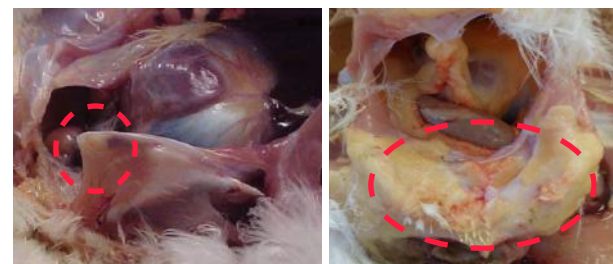

Pelvic bones at 18 weeks of age without fat deposits on the outside (left). Pelvic bones at 21 weeks with fat and tissue deposits on the outside depression of the pelvic bone (right).



Key Point

Never delay photo stimulation beyond 161 days of age or if the hens are too heavy (2700 g; 5.95 lb). If hens are too heavy, the laying cycle will be negatively impacted.

Female Feed Management: from Photo Stimulation to Peak Production

5

For any breeder flock, the period from the moment of photo stimulation to peak production is critical in terms of nutrition. After photo stimulation, the female will partition the available nutrients between maintenance, growth and the development of the reproductive system. A well-designed management program can influence how this partitioning takes place.

5.1 Female Feed Management from Photo Stimulation to Onset of Lay

From photo stimulation to onset of production, feed is allocated based on bodyweight. Birds that are photo stimulated with the correct body condition, usually require feed increases between 2 to 4 g/bird/week (0.44 to 0.88 lb/100 birds/week). If higher feed amounts are used, for example 4 or 5 g/week (0.88 to 1.10 lb/100 birds/week), consider increasing the feed amounts in 2 steps such as every 4 days with 3 and 2 g (0.66 and 0.44 lb/100 birds/week) increments.

Using conservative feeding programs from photo stimulation to onset of production will help reduce:

- ✓ The percentage of double yolks
- ✓ Low peak production issues
- ✓ Floor eggs, especially with community nest systems
- ✓ Egg peritonitis during the onset of peak production as well as spiking mortality due to prolapse, SDS, heart attacks, and fatty liver
- ✓ Overweight pullets because weight gain will be easier to control
- ✓ Production persistency related issues



Immature pullet



Pullet at 23 weeks of age



Key Point



Observe and handle the birds, checking crop fill uniformity to ensure that they are eating and drinking well. Check fleshing, weigh a sample of females weekly (1 to 2 % or 60 to 100 birds), to calculate mean bodyweight and flock uniformity.

5.2 Feeding and Its Influence on Weekly Mortality Trends

Weekly mortality comparisons for aggressive versus conservative feeding programs indicate, that after photo stimulation, higher weekly hen mortalities occur with aggressive feeding programs, similar to those used in the table to the right.

When the flock reaches 5 % daily production, a feeding program should be designed to lead production through peak. This program can be developed by deducting actual feed at 5 % of production from expected peak feed. Calculate the incremental increases for each 10 % increase in egg production. Feed hens for bodyweight until 5 % production is reached. Thereafter feed, increases should be adjusted according to daily egg production. Normally 40 % of the difference in total feed increase is given from 5 % until 45 % daily production and 60 % of the feed allocation between 45 and 80 % production. **Peak feeds are given at varying daily production levels, from 70 % through > 80 %. It is important for each company to evaluate their daily production and bodyweight increases through peak to see if they are over feeding. Weekly mortality linked to egg peritonitis are a clear indicator of over stimulation.**

Weekly feed increases in normal and aggressive feeding programs			
Week of age	Weekly feed increase (g)		Timing
	Normal	Aggressive	
20	6	6	Preparation for photo stimulation
21	5	5	Photo stimulation
22	2	5	From light stimulation until 5% production, give small feed increases
23	3	5	
24	2	5	
25	2	5	

Ensure quality feed ingredients in terms of energy and protein levels are being used for flocks going into peak production. Apply the latest Cobb recommended feed specifications to ensure that the females maximize their egg production. Birds going into peak are more susceptible to stress. Good quality ingredients are essential to give support to the birds, and for producing good quality chicks.

The hens should be capable of sustaining peak production on the 24 to 25 g of protein per day, 1000 to 1050 mg of digestible lysine and 950 mg of digestible methionine + cysteine. Large variations in house temperature will influence the amount of feed hens require. House temperatures should ideally be held between 21 °C (70 °F) and 22 °C (72 °F). Feed allowances may need to be adjusted to accommodate environmental conditions outside of this range.

3 examples of maximum feed energy levels in kcal based on different housing, environmental conditions and feed forms

Example 1: Use 435 to 445 kcal (1.81 to 1.85 MJ/kg) with good pelleted or crumbled feed and environmentally controlled houses.

Example 2: Use 445 to 455 kcal (1.85 to 1.90 MJ/kg) with crumbled or mash feed and environmentally controlled houses.

Example 3: Use 460 to 470 kcal (1.92 to 1.96 MJ/kg) in open sided houses in temperate climates.

*Peak feed intake should be reached by 75 to 80 % hen day egg production. The maximum feed amount will depend on the feed form and energy value, typically between 435 and 470 kcal (1.81 to 1.96 MJ/kg).

The tables below exemplify feeding practices from 5 to 75 % daily production. The data are based on a worldwide average with hens on a crumble feed maintained within their thermal neutral zone (ambient temperatures between 20 and 22 °C; 68 to 71.6 °F).

Production Percentage	Feed in grams based on crumble feed and at 20 to 22 °C house temperature				Feed Increase in g/bird/day	kcal/day (MJ/day)
	2900 kcal/kg (12.1 MJ/kg)	2800 kcal/kg (11.7 MJ/kg)	2700 kcal/kg (11.25 MJ/kg)	2650 kcal/kg (11.0 MJ/kg)		
5	111	115	119	122	3	322 (1.34)
15	114	118	122	125	3	330 (1.38)
25	117	121	125	128	3	339 (1.41)
35	123	127	132	134	6	356 (1.48)
45	130	135	140	143	8	378 (1.58)
55	140	145	150	153	10	406 (1.70)
65	150	155	161	164	10	434 (1.81)
75	157	163	169	172	to max	454 (1.89)

From the table:

- ✓ The feed amount at 5 % daily production depends on the kcal (MJ) level.
- ✓ Worldwide the energy level in most production feeds is usually about 2800 kcal (11.7 MJ/kg). At this level the average feed amount at the start of production (5 %) is about 115 g (25.3 lb/100 birds).
- ✓ At 45 % daily production and an energy level of 2800 kcal (11.7 MJ/kg), the average feed amount needs to be in the 135 g (29.7 lb/100 birds) range and never in the 145 g (31.9 lb/100 birds) range. This higher feed amount will result in considerably over weight hens at peak production and in most cases higher mortality.
- ✓ To prevent over feeding the hens from onset of production to peak, feed increases are done every 3 days and never daily.
- ✓ Making daily increases usually result in over weight hens at peak production and beyond.
- ✓ In tropical regions and house temperatures significantly higher than the birds thermoneutral range, the kcal (MJ) intake at peak production will be lower: 435 to 445 kcal range (1.81 to 1.85 MJ/kg).
- ✓ In naturally ventilated open sided houses in cold weather, the kcal (MJ) intake at peak production will be higher (>470 kcal; >1.96 MJ/kg)

Production Percentage	Feed in pounds per 100 birds based on crumble feed at 68 to 71.6 °F house temperature				Feed Increase in lb/100 birds/day	kcal/day
	1315 kcal/lb/100 birds	1270 kcal/lb/100 birds	1225 kcal/lb/100 birds	1202 kcal/lb/100 birds		
5	24.47	25.35	26.23	26.90	0.66	322
15	25.13	26.01	26.90	27.56	0.66	330
25	25.79	26.68	27.56	28.22	0.66	339
35	27.12	28.00	29.10	29.54	1.32	356
45	28.66	29.76	30.86	31.53	1.76	378
55	30.86	31.97	33.07	33.73	2.20	406
65	33.07	34.17	35.49	36.16	2.20	434
75	34.61	35.93	37.26	37.92	to max	454

Prod. %	g of feed	Prod. %	g of feed	Prod. %	g of feed	Prod. %	g of feed	Prod. %	g of feed
5	115	21	118	37	127	53	135	69	155
6	115	22	118	38	127	54	135	70	155
7	115	23	118	39	127	55	145	71	155
8	115	24	118	40	127	56	145	72	155
9	115	25	121	41	127	57	145	73	155
10	115	26	121	42	127	58	145	74	155
11	115	27	121	43	127	59	145	75	163
12	115	28	121	44	127	60	145	76	163
13	115	29	121	45	135	61	145	77	163
14	115	30	121	46	135	62	145	78	163
15	118	31	121	47	135	63	145	79	163
16	118	32	121	48	135	64	145	80	163
17	118	33	121	49	135	65	155	81	163
18	118	34	121	50	135	66	155	82	163
19	118	35	127	51	135	67	155	83	163
20	118	36	127	52	135	68	155	84	163

Above is a copy of a spreadsheet used to calculate feed amounts from 5 % through peak, based upon daily production. The example below starts at 5 % daily production and 115 g (25.3 lb/100 birds) daily feed. This table in electronic form is available from your Cobb technical representative.

How to use this table:

1. Type in the amount of feed that the flock is consuming at 5 % daily production. The table automatically adjusts the feeding program based on daily production assumptions until a peak feed at 75 % daily production.
2. If the peak feed amount given is higher or lower for a particular operation, manually change the maximum feed amount at 75 %.
3. Feed increases should be made every 3 days - use current daily production percentage for the appropriate daily feed amount. This feed amount should be used for the following 3 days.
4. At 75 % daily production the maximum feed amount is given.
5. There are many different housing and environmental conditions making it impossible to give a definitive energy requirement. Always discuss maximum feed energy amounts with your local Cobb technical representative.

Key points of female feed management (photo stimulation to onset of lay)

- ✓ An accurate and regularly calibrated feed weighing system is essential.
- ✓ Daily feed amounts must be calculated based on the actual bird number, not the number of birds initially housed. (Actual bird number = Birds initially housed - cumulative mortality and culling).
- ✓ Mash feed cleanup should be 2.5 to 3 hours for hens in peak production. Pellet or coarse crumble feed cleanup time should be 1.5 to 2 hours. Any sudden changes in cleanup time should be investigated immediately.
- ✓ It is strongly recommended to use the Cobb nutritional specifications that have been specifically formulated for the Cobb females and males.
- ✓ Breeder 2 feed containing higher levels of calcium and calories may be beneficial at around 35 to 40 weeks of age.
- ✓ Scratch feed may be beneficial to maintain fertility. It should be fed late in the afternoon at the maximum rate of 0.5 kg (1.1 lb) per 1000 birds, with this amount being included in the daily feed amount.
- ✓ Prevent feed wastage. Check for worn feeder troughs and spillage at the return to the feed hoppers.
- ✓ Maximum feed levels in the troughs should be set at 1/3rd full. Check slide gates daily for correct opening.
- ✓ The hopper inlet and outlet opening for the feed needs to be increased when using higher corners.
- ✓ Continue to run the feeding system until the entire day's feed allowance has been distributed by the chain feeder.
- ✓ Feeding can be run automatically without people present, but the equipment needs to be well maintained. Old equipment requires staff to be present during feeding.

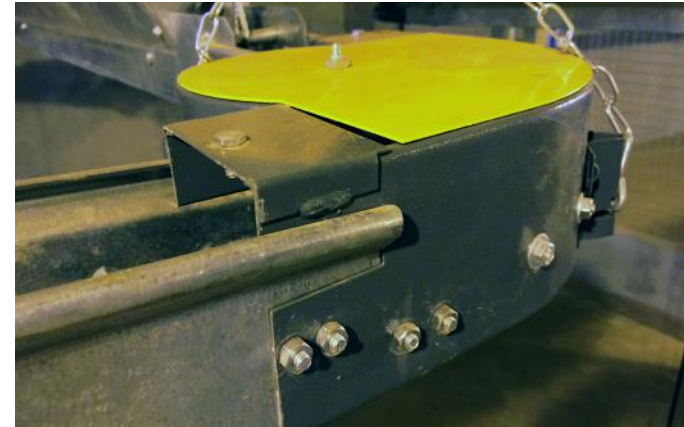

- ✓ Chain feeders with high corners prevent feed from spilling out of the trough and therefore, permit higher feed levels in the trough (see image above).
- ✓ The same procedures apply for pan feeders – generally pan feeder systems work better with pelleted and/or crumbled feeds. Fine mash feed will not normally work well with auger pan feeding systems.
- ✓ Silos should always be emptied between feed types and at least once a month during production to maintain good feed quality.
- ✓ ***Cobb does not recommend a pelleted feed during production phase due to very fast cleanup times, which may negatively affect feed distribution and performance, and increase nervous behavior causing scratches on thighs. Pelleted feed is only a good option under heat stress in peak production and/or with long feed cleanup times.***



Animal Welfare Tips

To prevent overfeeding or underfeeding the flock, the feeding system (scale or weigh bin) should be calibrated before birds are placed in the laying house. If a separate male and female feeding system are used, each should be calibrated. If feed increases do not seem to match the expected outcome (body weight, egg production levels, etc.), verify the calibration of the system to ensure that the feed allocation is accurate with the actual feeding system allocation.

5.3 Feeding Hens after Transfer and in Production: Early and Late Morning Feeding

There are 2 programs for feeding broiler breeders in production:

Program 1 (Early Feeding) :

This program is used by 80 to 90 % of producers worldwide. With this method, feed distribution is initiated in the dark a few minutes before the lights come on in the morning, or up to 1 hour after the lights turn on. This program is preferred with single hole mechanical nests or manual collections. These nest systems cannot accumulate large volumes of eggs and must be gathered 4 to 5 times per day. This program is used in good performing operations, with minimal mechanical issues in terms of feed distribution.

If the birds are being fed 1 hour after the lights are on, switch off the lights when feed distribution starts to keep the birds calm and to get the best feed and bird distribution over the length of the house. The chain feeding systems should make one complete round before lights are turned on.

Program 2 (Late Morning Feeding) :

This is the preferred program when there are management issues such as feed distribution, eggshell quality, labor or high numbers of floor and slat eggs. Although this program is not as widely used, it is quite effective under certain conditions. Good environmental control is very important to prevent any heat stress – do not use this program during the hottest part of the year without good environmental conditions.

Feeding late morning or 7 to 8 hours after the lights turn on in dark out housing, is done by switching off the lights during feed distribution. The lights are switched on when the first loop of chain feeders has been filled.

Some key points to consider when deciding on a feeding program

Program 1:

- ✓ Reduces heat stress and metabolic issues when using early feeding in tropical regions, especially during hot summer months or when houses do not have optimal environmental conditions.
- ✓ The hens have a stronger appetite with shorter consumption time when temperatures are cooler in the morning.
- ✓ This program allows afternoon mating activity with fewer interruptions.
- ✓ Equipment malfunctions can be detected early in the morning providing more time during the day for repairs.

Program 2:

- ✓ Begin late morning feeding during rearing, so that birds are accustomed to the feeding time. Typically, during rearing, feeding time is slowly moved from 8 AM at 10 weeks to 11 AM at 16 weeks of age.
- ✓ Delaying feed delivery allows producers to measure dry bodyweight (bodyweight before daily feed consumption).
- ✓ For young flocks, 8 hours after the lights are turned on, more than 90 % of the daily production has already been laid in the nests. Thus, in the early morning hens will not leave the nests for feeding.
- ✓ Late morning feeding allows a later start time for farm personnel. When arriving in the morning, personnel can go straight to egg collection.
- ✓ With late feeding, personnel are more likely to be present if equipment malfunctions during feeding.
- ✓ Late morning feeding is easier with community nest systems that allow 7 to 8 hours of egg production to accumulate on the central egg belt (50 cm wide).

5.4 Bodyweight Increase from Onset of Lay to Peak Production

Monitoring bodyweight increases from onset to peak of production is a good indicator of feeding program management, because it provides forecasting of peak production and post peak production persistency. Peak production is determined by uniformity, bodyweight and feeding program in the rearing period. A good benchmark is to measure the weight gain of females from the onset of lay to peak egg production. Onset of lay being defined between 0.5 and 3.0 % weekly production. A bodyweight increase of 13 to 15 % is used when the bodyweight of the females is on standard and up to 5 % over or under the standard bodyweight. ***If the production in the first week surpasses 3 %, feed amounts can be based on the average bodyweight from the week before to perform the calculation.***

Analysis of 3 flock scenarios:

	Flock 1	Flock 2	Flock 3
Age	Bodyweight (g) increase of 17 %	Bodyweight (g) increase is not sufficient	Bodyweight (g) increase is too great
24	3120	3120	3120
25	3240 (+120)	3170 (+50)	3320 (+200)
26	3340 (+100)	3240 (+60)	3520 (+200)
27	3440 (+100)	Feed must be increased faster to provide more kcal (MJ) support	Excess has been given 2 to 3 weeks earlier. Adjust in young flocks
28	3530 (+90)		
29	3600 (+70)		
30	3660 (+60)		
31	3700 (+40)		

In the table (left), the most important data to manage flock performance are age, bodyweight, feed amount and percentage of production along with the timing of the first light increase. The standards are only a guide and use the Cobb 500 Fast Feather in closed housing as an example. A poultry technician can forecast based on the onset of production what the bodyweight should be at peak production and with the addition of a further 500 to 600 g (1.1 to 1.3 lb) the forecast bodyweight of the females at 65 weeks. This data could be used by the poultry technician to forecast the standard bodyweight profile for each flock over the production period. Optimum weighing programs include weights of females and males through 35 weeks of age, and then every 2 weeks from 35 to 50 weeks of age, and then every 4 weeks through the end of the flock.



Key Point

There should be a 13 (fast feather) to 15 % (slow feather) increase in female bodyweight from onset of lay to peak production.

Production increase to peak production

Production increases over the first 3 weeks are a good indicator of peak production and persistency. The table (right) gives an example of 4 high performing flocks that are sexually synchronized and with peaks of 88 %. The table demonstrates production increases that are required for good peak production. Flocks with an average start at 1 to 3 % weekly production should increase production by 10 times the from the 1st to the 2nd week and double production from the 2nd to the 3rd week. This will indicate good sexual uniformity in flocks. In the table (right) Flock D resembles Flock A but Flock D starts production 1 week earlier. In general, by 28 weeks, all flocks should be above 80 % weekly production performance.

Week	Flock			
	A	B	C	D
24	0	0.2	0.3	0.9
25	1	2	3	9
26	10	20	30	45
27	45	50	60	70
28	70	75	80	85
29	82	85	87	88
30	86	87	88	88
31	88	88	88	88

5.5 Post Peak Feeding – Feed Reduction

Broiler breeder hens are predisposed to become over weight and over fleshed, which could affect persistency of lay and fertility. Being over weight could potentially result in an increase in floor eggs due to difficulty in accessing the nest boxes. Peak production is the point at which the average percentage of production for the past 5 days begins to decrease. Reduction in the daily feed amount is important to maintain hen performance.

The following are 2 scenarios often encountered in the field and examples of solutions:

Over feeding at peak:

Decrease feed by 5 g post peak over 2 weeks. Then, decrease 1 g per week through 40 weeks. Finally, decrease 1 g per week every 4 weeks until the cumulative drop in feed is 7 to 10 %. (5 g per week = 1.10 lbs per 100 hens per week; 1 g per week = 0.22 lbs per 100 hens per week)

Correct feeding in peak:

Maintain peak feed for 2 to 3 weeks and decrease slowly with maximum of 1 g per week until total drop in feed is 5 to 7 %. More feed decreases are possible based on your local conditions including flocks going from winter to summer periods and depending on the energy specifications of the Breeder 2 feeds. (1 g per week = 0.22 lbs per 100 hens per week)



Key Point

Flocks peaking at 87 to 91 % production are recommended to remain on peak feed for an extra 1 or 2 weeks. For each 2 % production above 87 %, add 1 g of feed to help sustain the high production performance. These flocks do not tend to become overweight because the females are converting feed into high egg mass output.

Periodic handling of the hens, along with weighing, is necessary to determine subtle changes in body composition, condition and fat reserves of the hens. Additional items to consider when determining the feed reduction schedule:

- ✓ Cleanup time: A feed cleanup time of 1.5 hours for crumble feed and up to 3 hours for mash feed is considered normal. A flock that consumes the daily ration in less time may not be receiving the nutrients needed and may be hungry. Early feed withdrawal post peak could adversely affect production. Cleanup times of 3.5 to 4.0 hours will result in over weight birds, poor uniformity and excess feed amounts in peak production. Extended cleanup time can also lead to selective eating - birds selecting coarse particles and leaving the fine particles. This will cause a loss of uniformity and performance (egg numbers and female fertility). Furthermore, selective eating can reduce vitamin and mineral intake as these may be part of the fine feed materials. A faster peak feed withdrawal may be considered.
- ✓ Egg Mass: Egg weight and bodyweight are directly correlated. A higher bodyweight will normally result in a higher egg weight. Introducing Breeder 2 feed when egg weight is at 60 g for fast feather and 62 g for slow feather females can be an efficient way to control bodyweight and egg weight.
- ✓ Breeder 2 feed should always have the same or somewhat higher energy level as Breeder 1. Energy intake allows the females to produce and maintain production of eggs.

5.6 Hen Feathering During Production

Feather quality and cover of the hens in production is a very important indicator of production persistence and high fertility. The following are some of the primary reasons for rapid feather loss in breeder hens:

- ✓ Feathering issues in rearing due to management or low essential amino acid profiles in the pullet grower feed.
- ✓ Insufficient feeder space between 20 and 27 weeks when feed cleanup time is very fast.
- ✓ Feed distribution with lights on, resulting in overcrowding in parts of the house such as around distribution hoppers. This could also result in thigh scratches from females.
- ✓ Feed distributing with lights on results in hens running along feed tracks, inducing stress and internal lay or egg peritonitis.
- ✓ Low conditioning and fat reserves at photo stimulation. These females can show more feather wear as early as during peak production.
- ✓ Tight feed restriction grill (<45 mm or 3/4 in) will affect the heavier females after 40 weeks. These females will have trouble consuming enough feed leading to a drop in production and even molting. Their heads may experience feather loss and swelling because of the tight grill. This swelling should not be confused with swollen head syndrome or pneumo-virus.
- ✓ Over mating by males.
- ✓ Any feed passage, flushing or diarrhea reducing the absorption of nutrients.
- ✓ Chronic enteritis in the duodenum.



Animal Welfare Tips

Welfare quality assessments can be conducted during routine visits to assess flock health: feathering (coverage and quality), skin condition (foot pad quality, presence of scratches, etc.), behavior & distribution of the flock within the house, social interaction of males and females, physical characteristics (eye, beak, comb, feet, etc.), and coloration (comb, legs of roosters).

6

Lighting Program Management

The response of chickens to light is a complex subject. Local conditions and housing types may require the use of modified lighting programs, which should be discussed with your Cobb Technical Service representative.

Photo stimulation (increasing lighting time and intensity) should start at 21 weeks or between 147 and 154 days of age. It typically takes 14 to 16 days until the first egg and another 7 days to reach 1 to 2 % daily production. Once photo stimulation occurs, birds should never experience a decrease in day length in the production cycle. Artificial light should be used to cover sunrise and sunset in clear curtain or open houses. Flocks that start production at 24 weeks, show cumulative increases in hatching eggs (HE) through week 30. These flocks are often the most productive flocks if they persist well with low mortality. **At photo stimulation, the increase in the amount of time birds are exposed to light is more important than the increase in light intensity.**

Light intensity in production is normally maintained to encourage bird activity and for caretakers to perform their routine house inspections and management of birds and litter. As an emergency procedure, reducing the light intensity from 70 to 35 lux (7 to 3.5 fc) will help reduce culling or mortality due to cannibalistic behavior. Light intensity reduction, after photo stimulation, should not reduce production performance but can affect the sexual maturity of the males. Males are more sensitive to light intensity for correct sexual maturity.

LED lighting

LED lighting has proven to work as well as the traditional light sources to bring parent stock into production with the advantage of a much lower energy cost. Compared to incandescent lights, high pressure sodium lights can reduce energy costs by 40 % over a 5 year period. However, compact fluorescent and LED lights can reduce costs by 63 % and 73 % over a 5 year period, respectively.

Currently, new light installations are primarily LED lamps/tubes or strings due to low energy consumption, long life span (>50,000 hrs), dimming ability, and adjustable color output. They are also easy to wash, clean and disinfect, and have a high Ingress Protection value (IP; related to the level of dust and humidity penetration).

LED lights have had a considerable impact on breeder management. The introduction of dimmer units (dusk to dawn) have made it possible to work in rearing with low light intensity outputs of 2 to 4 lux (0.2 to 0.4 fc) but still see well enough to manage the birds. Dimming ability is important in rearing to keep the birds calm and better primed for photo stimulation at 21 to 22 weeks of age. Furthermore, running lights at a lower intensity has a big impact on energy consumption (but be sure to have good light distribution over the entire house).

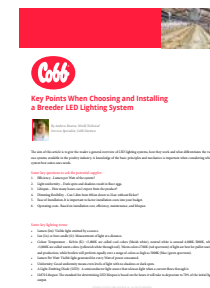

Learn more about LED lighting by downloading our white paper at <https://www.cobb-vantress.com/resource/white-papers>

Photo Stimulation

Broiler breeders are seasonal reproducers and, as such, are highly dependent on lighting cues for daily and reproductive activity. These birds require about 20 to 21 weeks consisting of short days (approximately 8 hours) before reproduction can begin. After this maturation time frame, exposing the birds to long periods of light (>12 hours) can stimulate the reproduction process given the birds are physically prepared. However, both the maturation period and physical condition are required to reach the full genetic potential of reproduction. Hastening maturation by overfeeding and exposing young birds to long photoperiods before they are prepared will delay the onset of lay, increase mortality and double yolks, and give slower increases of daily production to peak (after 31 weeks of age).

A graphical representation of photo stimulation:
Birds perceive light in blocks or fractions.

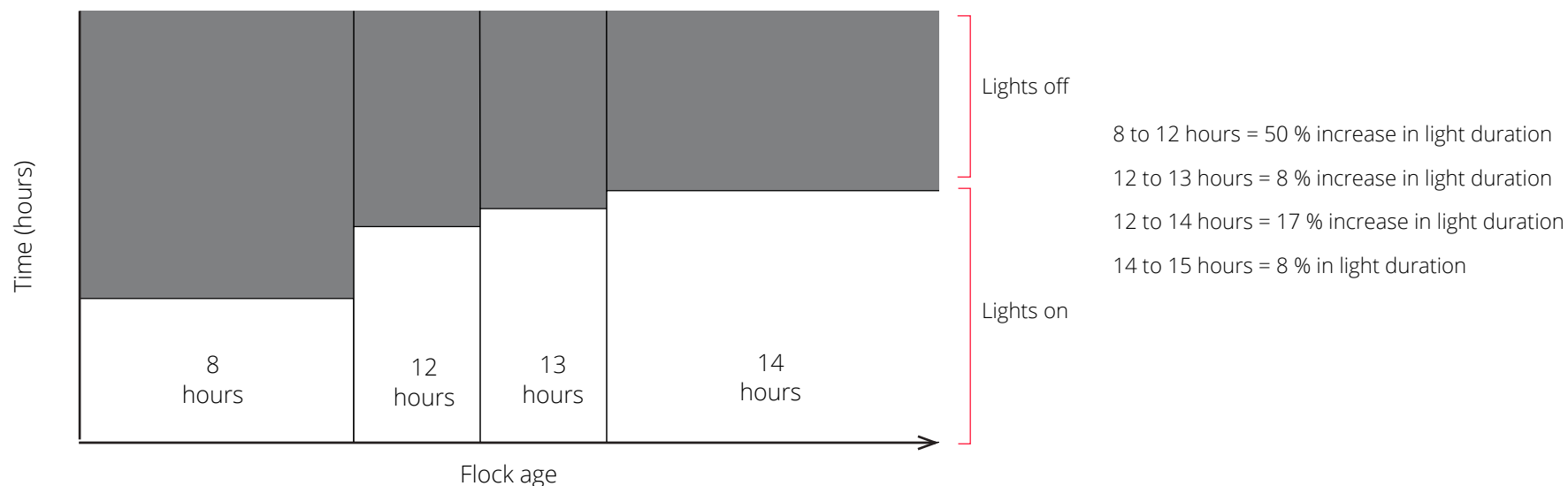

At photo stimulation, the flock should have*:

1. Uniform bodyweight, low Coefficient of Variation (CV 9 to <10) and high uniformity >70 %.
2. A majority of the females (>95%) with the correct bodyweight, pelvic fat and condition.

* See section 4.8 on more details regarding the preparation of a flock for photo stimulation.

6.1 Lighting Considerations when Transitioning from Rearing to Production

Ideally broiler breeders should be reared in lightproof housing to prevent the birds from perceiving seasonal photoperiods and ensure sexual uniformity at the start of production. Housing should be completely dark when the lights are off. Fans, perimeter inlets and the tunnel inlet must also be covered with adequate light traps. See Chapter 14 for more details on ventilation considerations when using light traps.

Dark out production houses

Females can receive a maximum of 12 to 14 hours of light in dark out production houses or in regions where the natural day length is less than 14 hours. This will provide good peak production and persistency and maintain the female's sensitivity to the light duration. Less than 11 hours of total light will have a negative effect on production. Light intensity should be a minimum of 70 lux (7 fc) for good sexual stimulation of the males.

Brown out rearing houses

Many operations worldwide do not have good dark out conditions in rearing and production and use brown out configurations. This means that the outside natural light penetrates to a high degree into the house and the flock establishes their daylight length in rearing based on the natural day light cycle. In regions close to the equator where natural day length is between 11 and 13 hours, supplementary lights are necessary.

In regions at high latitudes where natural light during the summer is 15 to 16 hours, the use of one day length will be required for the duration of the production cycle. If light traps are used directly on tunnel fans, it may be necessary to remove them under very hot conditions. In this case, natural light will enter the house and the artificial light program will need adjustments towards the maximum natural day light length. Any reduction in natural light can compromise production persistency.

Open sided rearing houses

Lighting programs in open sided houses are dictated by the natural light cycle and any artificial light program should be adjusted based on the maximum light hours required. Normally only flocks close to the equator - maximum 5° latitude, north or south - can be managed with only natural light.



6.2 Lighting Programs

There are 3 lighting programs based on housing configurations:

1. Dark out rearing to natural daylight production.
2. Dark out rearing to dark out production.
3. Natural daylight / brown out rearing to natural daylight production.

Dark out rearing to natural daylight production

Dark out houses should provide total light control. Start chicks on 23 hours of light reducing to eight hours by two weeks of age (see section 2.3 in brooding design). The 8-hour day length will begin when feed cleanup times and bodyweights are on standard. Generally, the 8-hour day length can start when the birds consume their everyday restricted feed in 4 hours or less - usually 14 to 15 days. The 8-hours of light day length will continue until 21 to 22 weeks (147 to 154 days) of age when photo stimulation begins.

In rearing, 9 hours of light are used when the birds are being transferred to open sided production houses during the summer months with a natural light duration of more than 13 hours. Another option is to photo stimulate the hens in the rearing house between 147 to 154 days of age by increasing artificial light from 8 to 12 hours. Hens then are transferred at 154 days of age and given 15 to 16 hours of natural day light, which will prevent over stimulation. It is not always possible to apply this program based on the down time between flocks. The artificial light system must provide a minimum of 50 and a maximum of 100 lux (5 to 10 fc) during the production period, with 70 lux (7 fc) being a good average light intensity for females and males.

Maximum natural light hours will always depend on the location's latitude for open sided houses. Flocks being transferred in autumn can receive only a maximum of 14 hours of natural light, but flocks transferred to open production houses in the summer will need to adjust the maximum light to the local hours of natural daylight.

Recommended lighting program for flocks going from dark out rearing to open sided or transparent curtain in production houses

Age (Weeks)	Age (Days)	Light (Hours)	Light intensity* (lux)	Light intensity (foot candles)
2 to 21	up to 146	8	2 to 4	0.2 to 0.4
21	147	12 (or natural light)	>50	>5
23	161	13 (or natural light)	>50	>5
25	175	14 (or natural light)	>50	>5
27	189	>14 (or natural light)	>50	>5

*If lighting system is not LED, light intensity (lux; fc) can be increased 20 to 30 %.

Dark out rearing to dark out production

Recommended lighting program for flocks going from dark out rearing to dark out production houses

Age (Weeks)	Age (Days)	Light (Hours)	Light intensity* (lux)	Light intensity (foot candles)
2 to 21	up to 146	8	2 to 4	0.2 to 0.4
21	147	12	>50 to 100	5 to 10
22	154	13	>50 to 100	5 to 10
23	161	14	>50 to 100	5 to 10
25	175	>14	>50 to 100	5 to 10

*If lighting system is not LED, light intensity (lux; fc) can be increased 20 to 30 %.

Fast feather females - photo stimulation starts between 147 and 154 days. Slow feather females - 150 to 154 days. In extreme cases, when females are under weight and under fleshed with insufficient pelvic fat reserves, photo stimulation can be delayed to 161 days.

Natural daylight or brown out rearing to natural daylight production

It is not recommended to rear breeders in natural daylight houses. However, this rearing system is successfully used in regions close to the equator where the variation in natural day length is minimal. During rearing the flocks can remain on natural light in all seasons until photo stimulation. The program used will depend on natural day length when the flock reaches 140 days of age. When the natural day length is insufficient, provide extra light at both the beginning and the end of the natural day light period to be certain that the intended day length is achieved. Additional light added during this period must be 80 to 100 lux (8 to 10 ft candles) to ensure that the birds are stimulated sufficiently.

Brown out rearing houses use a black shade cloth, plastic or combination of both placed along the sides of the house from the roof down. This system blocks up to 80 % of the natural light, hence the term brown out rearing. The challenge with this system is finding the balance between darkening the house and ventilation. (See Ventilation Chapter 14).

Brown out rearing can be successful in housing situated in regions where the natural light hours do not vary significantly. In regions outside 10° latitude north and south, day length variability will induce a delayed onset of production, causing dramatic drops in hatching eggs.

In open-sided and windowed houses, local day length conditions require that a specific program be adopted for each flock which can be optimized with the technical services representative.

Recommended lighting program for open sided housing according to natural day length at 140 days (20 weeks) of age

Natural day length hours at 140 days	Lighting program		
	147 days	154 days	161 days
14	16	17	17
13	15	16	17
12	14	15	16
11	14	14	16
10	13	14	15
9	12	13	14

6.3 Flock Sexual Uniformity

Flock uniformity greater than 70 % allows simultaneous increases in light duration (+4 hours) and intensity. Simultaneous increases will ensure most of the flock will be stimulated and a high sexual uniformity can be obtained. In this way, most of females will participate in peak production.

When uniformity is poor, the birds in the flock that are not yet ready for photo stimulation (under weight, under fleshed, too little pelvic fat) can be overstimulated. Photo stimulating birds that are not ready may lead to lower peak production and persistency with higher numbers of double yolks, floor eggs, egg peritonitis, mortality, and culls. Therefore, when flock uniformity is less than 70 %, the flock will require more and smaller incremental increases in light duration and intensity. For these flocks, it is recommended to first increase light intensity to 30 to 35 lux (3 to 3.5 fc) and increase light duration for 3 hours (from 8 to 11 hours per day). A week later, increase light duration for an additional 2 hours (from 11 to 13 hours per day) and intensity to a minimum of 50 lux (5 fc). The final increase should be a week later to an intensity of 70 lux (7 fc) as well as increasing duration for an additional hour (see table below for details).



Recommended lighting program for flocks with uniformity below 70%

Age (Weeks)	Age (Days)	Light (Hours)	Light intensity* (lux)	Light intensity (foot candles)
2 to 21	up to 146	8	2 to 4	0.2 to 0.4
21	147	11	30 to 35	3 to 3.5
22	154	13	50	5
23	161	13	70	7
25	175	14	70	7
27	189	14	70	7

*If lighting system is not LED, light intensity (lux; fc) can be increased 20 to 30 %.

Males and females can follow the same lighting and photo stimulation program prior to mixing. However, if males are reared separately, the light program for males can be different from the females depending on the male line used. See specific lighting recommendations for each male line in our supplements (<https://www.cobb-vantress.com/resource/product-supplements>).

7

Water Management

It is essential to provide easy access to fresh, clean water from day old so that feed intake and growth are maintained.

- ✓ The primary drinking system may be either bell or nipple drinkers.
 - ✓ Bell drinkers should be installed at the rate of one per 75 females in rearing and production.
 - ✓ Nipple drinkers should be installed at the rate of 8 to 10 females per nipple for rearing and production.
 - ✓ Nipples to be spaced at 20 cm (7 7/8 in) centers to ensure enough nipples when using only 2 nipple lines in a 12 to 14 m (39 to 46 ft) wide production house.
 - ✓ It is very important to install the correct nipple type. Day old chicks need 360° nipples with a pin that is long enough and easily activated - dynamic or sideways activation of 2 g of force.
 - ✓ In brood/grow/lay houses, the nipples should be a 360° dynamic nipple and never a static nipple. Static nipples can only be pushed up to access water and are difficult for chicks to activate in the first week.
- ✓ Nipple drinkers are the system of choice in most rearing and production houses due to their ease of operation, cleanliness and dryer litter condition.
 - ✓ If bell drinkers are used in rearing continue with bell drinkers in production. Never go from bell drinkers in rearing to nipples in production. The opposite is possible (going from nipples in rearing to bell drinkers in production). It is always better to have the same system in rearing and production to prevent stress and acclimation problems.
 - ✓ In a rearing house, 12 to 14 m (39.3 to 45.9 ft) wide, a maximum of 3 nipple lines should be installed with a 20 cm (7.9 in) nipple spacing. In rearing do not install too much drinker capacity. It is important to promote breeder activity. Too many drinker lines encourage lazy hens and can increase floor eggs in production.

There are currently 2 nipple configurations on the market, one with and one without drip cups. Drip cups offer the advantage of visual assessment of pressure. Too much water in the drip cups indicates pressure is too high or the nipple line is too low. A moist drip cup indicates the pressure is correct and a dry drip cup indicates that the nipple is not working.

Nipple types have 2 different manufacturing options:

Stamped nipples - less expensive and considerably lower in quality. More leaking issues and often more difficult to activate by day old chicks.

Turned nipples - higher quality than standard nipples due to more precise machining and an easier nipple pin to activate.



Turned nipple with precision machining.



Drip cup on left with lower profile most suitable for rearing.

Drinker height recommendations

Adjust drinker height as the birds grow so they stretch their neck slightly and should never have to lower their heads to drink. Birds should never have to jump to reach water. They should be able to drink with their feet flat on the floor.

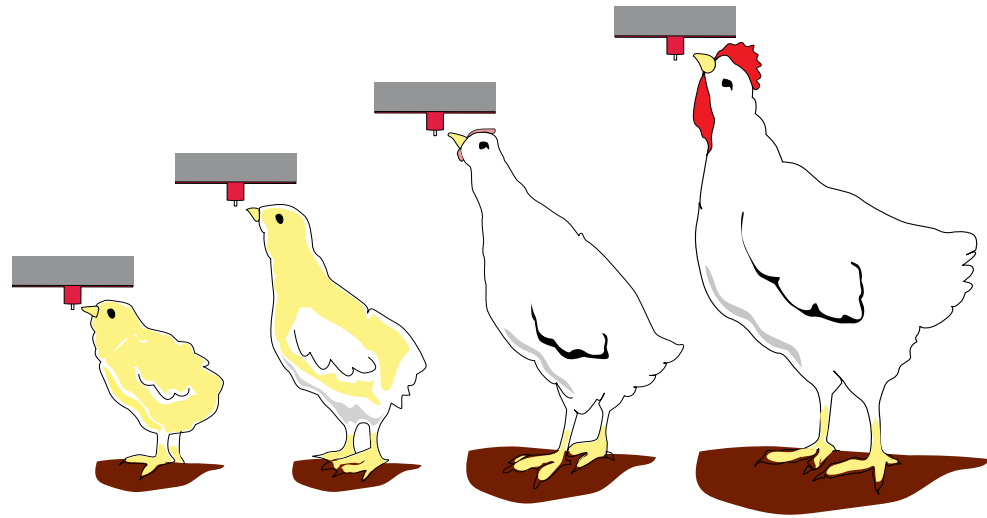

At placement, nipple pin should be at chick eye level.

At day 2 and beyond, adjust height so that the bird's head is at a 45-degree angle to the nipple.

7.1 Mineral Content

Although breeders are tolerant of higher levels of some minerals, (calcium and sodium, for example), they are very sensitive to the presence of others. Iron and manganese tend to give water a bitter taste that may decrease consumption. In addition, these minerals support the growth of bacteria. If iron is a concern, filtration systems and chlorination are effective controls. It is advisable to filter the water supply using a filter with a mesh of 40 to 50 microns. The filter should be checked and cleaned at least weekly.

Calcium and magnesium in the water are measured by hardness. These minerals in combination can form scale or deposits that will compromise

the effectiveness of a drinker system. This is especially true of closed drinker systems. Water softeners can be incorporated into a system to mitigate calcium and magnesium impacts. However, sodium levels should be assessed before a salt-based, water softener product is used.

Breeder performance can be impeded by as little as 10 ppm of nitrates. Unfortunately, there are currently no cost-effective options for nitrate removal from drinking water. Water should be tested for nitrates because elevated levels may indicate sewage or fertilizer contamination.



Animal Welfare Tips

Birds will consume most of their daily water requirements 2 to 3 hours after eating. A drop in consumption could indicate a restriction or supply issue. Adequate water storage and supply capacity are key to prevent shortages. Always perform crop check during weekly weighing after feeding, to evaluate whether > 90 % of the birds have soft crops. Evaluate daily total water consumption and bird behavior in each house. In rearing, birds will drink more on the "on-feed" days than the "off-feed" days. In rearing and laying houses, if there are any dramatic and unexpected changes in daily water consumption, evaluate the reason(s). Possible items to investigate include: feed (quality and amount consumed), temperature, drinker maintenance (pressure, flow rate, leaks, air blockages, stray voltage), water quality, and bird health status.

Oxidation-Reduction Potential (ORP) chlorination value

Another important factor is the ORP value of the water which refers to the property of chlorine sanitizers to be a strong oxidizer. A strong oxidizer kills and destroys viruses, bacteria and other organic material present, leaving water microbiologically safe. An ORP value in the range of 650 mV or greater indicates good quality water. The lower the value, such as 250 mV, indicates a heavy organic load that will most likely overwhelm the ability of chlorine to properly disinfect the water.



The ORP meter can be a useful tool for identifying and maintaining adequate chlorine supplies without overusing chlorine.

Chlorine

- ✓ Swimming pool chlorine test kits do not distinguish between free and bound chlorine. Although these test kits might indicate chlorine levels of 4 to 6 ppm, a heavy organic load could still be present with bound chlorine. In this case, there is no free chlorine available to act as a sanitizer.
- ✓ Chlorine is most effective when used in water with a pH of 5.0 to 6.5. This pH level results in a greater percentage of active hypochlorous ions which are a strong sanitizer.
- ✓ Inorganic acids such as sodium bisulfate reduce water pH without tainting the water.
- ✓ Free chlorine residual levels are not considered useful as sanitizers unless there is at least 85 % hypochlorous acid present.

The most common sources of chlorine include:

- ✓ Sodium hypochlorite (NaOCl, household bleach) increases water pH so it is a poor option as a water sanitizer.
- ✓ Trichlor (trichloro-s triazinetrione) which contains 90 % available chlorine and is in the form of tablets and slowly releases chlorine over time. These reduce water pH providing a good option as a water sanitizer.
- ✓ Chlorine gas is available as 100 % chlorine and is the purest form of chlorine, but it can be dangerous and is restricted in its use.

pH

- ✓ pH is the measure of how many hydrogen ions are in solution and is measured on a scale of 1.0 to 14.0 with 7.0 being neutral. A pH value below 7.0 indicates an acid while numbers above 7.0 indicates an alkaline.
- ✓ pH above 8.0 can impact taste by causing bitterness, thus reducing water consumption.
- ✓ High water pH can be reduced by using inorganic acids. Without proper water sanitation, organic acids can promote bacterial growth. Organic acids can also negatively affect water consumption and are discouraged.
- ✓ pH impacts water quality and the potential effectiveness of disinfectants such as chlorine.
- ✓ At a pH above 8.0, the chlorine is present mainly as chloric ions, which have very little sanitizing quality.

Impact of pH on the ratio of hypochlorous (HOCL) to chloric Ion (OCL)		
pH	% Hypochlorous Acid - HOCl	% Hypochlorite Ion - OCl
8.5	10	90
8.0	21	79
7.5	48	52
7.0	72	28
6.5	90	10
6.0	96	4
5.0	100	0

The ideal drinking water pH for a disinfection water program is between 5 to 6.5

7.2 Microbial Contamination

Chronically poor performance may indicate contaminated water and requires immediate testing. When testing water, evaluating the total coliform bacterial count is important, as high levels can cause disease. Assessing the total bacteria with a plate count will reflect the effectiveness of the water sanitation program. Microbial contamination can be introduced from the original water source and at any point in the water delivery system. If an effective water sanitation program is not in place, growth of bacteria will readily occur. Water storage tanks are common to ensure there is an adequate water supply during peak usage. Treat the water before pouring into the tank to prevent microbial contamination and growth.

Test the water if there is (are)

- ✓ a noticeable change in color, odor or taste
- ✓ flooding that has occurred near the well
- ✓ a person or animal that becomes sick from waterborne disease on the premises
- ✓ maintenance on the water supply system
- ✓ flocks that have persistently poor performance
- ✓ a major loss of flow or pressure in water system

7.3 Total Dissolved Solids

Measurement of total dissolved solids (TDS), or salinity, indicates levels of inorganic ions dissolved in water. Calcium, magnesium and sodium salts are the primary components that contribute to TDS. High levels of TDS are the most commonly found contaminants responsible for causing harmful effects in poultry production (as shown in the comments section in the table on the right.) The following table provides guidelines for the suitability for poultry water with different concentrations of total dissolved solids (TDS), which are the total concentration of all dissolved elements in the water.

Suitability of water with different concentrations of total dissolved solids (TDS)

TDS - ppm	Comments
Less than 1,000	Water suitable for any class of poultry.
1,000 to 2,999	Water suitable for any class of poultry. It may cause watery droppings (especially at higher levels) but with no effect on health or performance.
3,000 to 4,999	Water not suitable for any class of poultry. Can cause watery droppings, increased mortality, and decreased growth.
5,000 to 6,999	Water not suitable for any class of poultry. Will almost always cause some type of problem, especially at the upper limits, where decreased growth and production or increased mortality probably will occur.
7,000 to 10,000	Water unfit for poultry but may be suitable for other livestock.
More than 10,000	Water should not be used for any livestock or poultry.

7.4 Drinking System Cleanout Between Flocks

1. Determine the capacity of the drinking system.
2. Drain drinking system and vaccination (doser) tanks.
3. Where possible, remove vaccination (doser) tank and scrub it clean. If using a gravity fed header tank, drain and clean.
4. Prepare the cleaning solution to the manufacturer's recommendation. Make sure protective clothing and eyewear are worn when using chemicals.
5. Introduce the cleaning solution into the water system.
6. Turn on the tap at the end of the drinking line and let the water run through until the cleaning solution appears, then close the end tap.
7. Raise each drinker line.
8. Allow the solution to fill the drinking system.
9. Let the cleaning solution stand for at least 12 hours.
10. After draining the system, flush the system thoroughly to remove biofilm and cleaning chemical.

7.5 Water Sanitation and System Cleanout

A regular water sanitation and water line cleaning program can provide protection against microbial contamination and the buildup of slimy biofilms in water lines. While biofilms may not be an immediate source of problems to birds, once established in water lines, biofilms provide protection for bacteria and viruses from disinfectants. They can also trap organic material, a food source for microorganisms. The use of various poultry products in water lines (ex: vitamins, electrolytes, organic acid, vaccines, vaccine stabilizers, antibiotics and probiotics) can all contribute to the growth of a biofilm. As a result, special attention to internal drinker line cleanliness should be initiated after the use of any of these products.

Products containing hydrogen peroxide are proven effective at removing biofilms in water lines. Potassium peroxymonosulfate (also known as MPS, KMPS, potassium monopersulfate, and potassium caroate) are non-chlorine oxidizers that are also effective against biofilms.



Biofilms and organic material can build up in water lines over time leading to reduced water flow.

7.6 Water Testing

General water testing should be performed on a periodic basis but at least yearly. Samples should be collected at both the well house and at the end of a drinker line using a sterile container and analyzed at an accredited laboratory (see following page for specifications of mineral contents present in water samples). When taking the water sample, it is important not to contaminate the sample.

Water sampling technique

Sterilize the end of the tap or nipple by using an open flame for 10 seconds (always take extra precaution when using an open flame). Never use a chemical to sterilize a nipple as it may affect the sample. In lieu of an open flame, run the water for a few minutes before taking the sample.

Contaminant, mineral or ion	Level Considered Average	Maximum Acceptable Level	Comments and Treatments
Bacteria			Total Bacteria is an indicator of system cleanliness, high numbers do not indicate harmful bacteria are present but it increases the risk of pathogenic organisms. High bacteria levels can impact taste of water resulting in reduced consumption by birds.
Total bacteria	0 CFU/ml	100 CFU/ml	
Coliform bacteria	0 CFU/ml	0 CFU/ml	Presence of any fecal coliform means water is unfit for consumption by poultry or humans.
Acidity (pH)	6.8 to 7.5	7.6	pH below 5 can be harmful to drinker equipment by causing corrosion to metal components (long term exposure). pH above 8 impacts the effectiveness of water sanitizers and is also associated with high alkalinity which may cause reduced water consumption in poultry due to "bitter" taste.
Total hardness (Ca and Mg)	60 to 180 mg/L	See comments	Hardness causes scale which can reduce pipe volume and make drinkers hard to trigger or leak. Hardness of water is classified as follows: 0 to 60 mg/L - soft water; 61 to 120 mg/L - moderately hard water; 121 to 180 mg/L - hard; and >180 mg/L very hard.
Naturally occurring elements			
Calcium (Ca)	60 mg/L	N/A	No upper limit for calcium, birds are very tolerant of calcium. If values are above 110 mg/l may require water softener, polyphosphates or acidifier to prevent scaling.
Chloride (Cl)	14 mg/L	250 mg/L	When combined with high sodium levels, creates saline water that can act as a laxative causing flushing. Salty water can promote the growth of <i>Enterococci</i> which may cause enteric issues. Saline water can damage reproductive tract in breeder birds causing shell quality issues. Treatment- reverse osmosis, lower dietary salt levels, blending with non-saline water. Keep water clean and use daily sanitizers such as hydrogen peroxide or iodine to prevent microbial growth.
Copper (Cu)	0.002 mg/L	0.6 mg/L	
Iron (Fe)	0.2 mg/L	0.3 mg/L	Birds tolerant of iron metallic taste but high iron causes leaking drinkers and promotes the growth of <i>E. coli</i> and <i>Pseudomonas</i> . Treatment includes oxidation with chlorine, chlorine dioxide or ozone followed by filtration.
Lead (Pb)	0	0.02 mg/L	Long term exposure can cause weak bones and fertility problems in breeders.
Magnesium (Mg)	14 mg/L	125 mg/L	Higher levels of Mg may cause flushing due to laxative effect particularly if high sulfate levels are present.
Manganese (Mn)	0.01 mg/L	0.05 mg/L	Can cause black grainy residue on filters and drinkers. Manganese can promote bacterial growth. In the bird, manganese may interfere with copper uptake and utilization. Treatment includes oxidation with chlorine, chlorine dioxide or ozone at a pH of 8 followed by filtration. Green sand filtration is an option.
Nitrate	10 mg/L	25 mg/L	If nitrates convert to nitrites, poor growth and feed conversion can occur due to the nitrites binding blood hemoglobin. Presence of nitrates may indicate fecal contamination so also test for bacteria. Can be removed with reverse osmosis.
Sodium (Na)	32 mg/L	50 mg/L	When combined with high chloride levels, creates saline water that can act as a laxative causing flushing. Salty water can promote the growth of <i>Enterococci</i> which may cause enteric issues. Saline water can damage reproductive tract in breeder birds causing shell quality issues. Treatment- reverse osmosis, lower dietary salt levels, blending with non-saline water. Keep water clean and use daily sanitizers such as hydrogen peroxide or iodine to prevent microbial growth.
Sulfate	125 mg/L	250 mg/L	Sulfates can cause flushing in birds. If rotten egg odor present in water, then hydrogen sulfide producing bacteria are present and system will require shock chlorination as well as the establishment of good daily water sanitation program. Sulfates can be removed by aerating water into a holding tank, treatment with hydrogen peroxide, chlorine or chlorine dioxide then filtration. With elevated sulfate levels, hydrogen peroxide is preferred since it requires an almost 2 to 1 ratio of sanitizer to sulfate for oxidation.
Zinc	N/A	1.5 mg/L	No known issues.

8

Bodyweight Control, Weighing and Analysis

There are 2 recommended ways to feed a flock in rearing and ensure that the birds are in condition at 20 weeks of age.

1. Feed according to the Cobb bodyweight profile that is specific for the breed. Be aware that a feed change takes 2 to 3 weeks to be detected in bodyweight change. Therefore, frequent increases and decreases in feed change can be confusing and result in fluctuating bodyweights which can induce stress and affect flock uniformity.
2. Feed according to a pre-determined and proven feeding regime with specific feed specifications. The birds are fed based on a program and the birds' bodyweights are kept between 98 and 102 % of the standard. If the bodyweight deviates too much from the standard the feed amounts should be adjusted up or down in small increments ranging from 1 to 3 g (0.22 to 0.66 lb/100 birds). Again, be aware that feed change takes 2 to 3 weeks to be realized in feed restricted birds.

The two described feeding methods may be used together. Initially, follow the first concept in which the feed amount is determined by the bodyweight development in rearing. Once a good feeding profile is determined, the second concept can be used making it easier on management in general. Using both methods will give more consistent results and success in meeting production targets.

The objective of bodyweight control is to rear all the birds to the target weight for age with good uniformity. Bodyweight targets are achieved by controlling feed allowances. Feed amounts during rearing are based on bodyweight gain and maintenance, whereas in lay they are based on these two factors including egg production and egg weight. Accurate feed amounts can only be determined if the bodyweight is measured accurately every week.

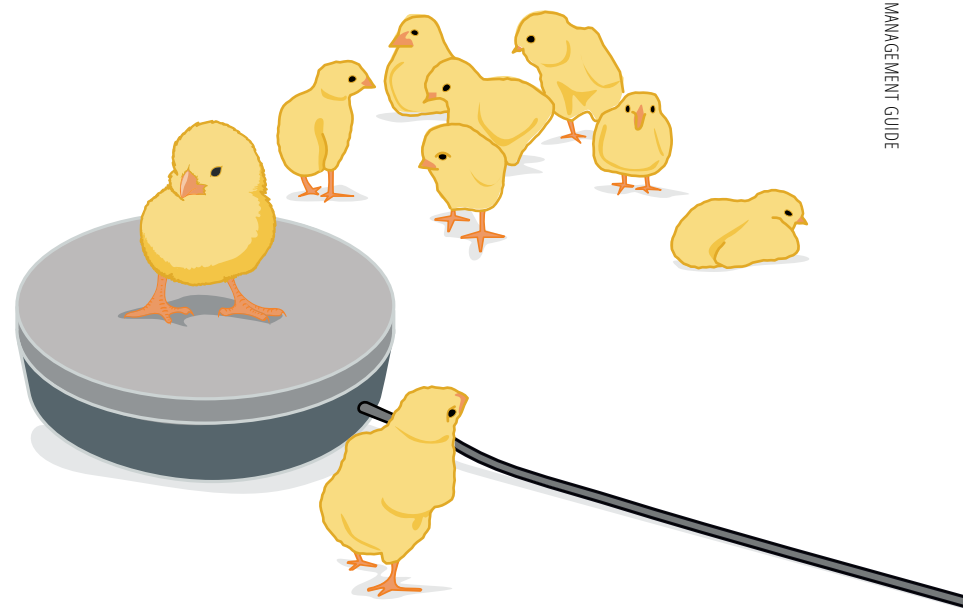

In rearing, chicks can be weighed in bulk by hand or by using automatic scales (as shown in illustrations).

8.1 Hand Weighing

The scales used to measure bodyweight must have a capacity of maximum 5 kg (11.02 lb) and be accurate to +/- 20 g (0.05 lb). Scales must be calibrated on a regular basis. It is advantageous to use electronic scales with a printout capability. This will reduce human error and assist the weighing team. At 3 weeks and older, weigh 3 % of the females and 10 % of the males or 50 birds as a minimum to guarantee a representative sample. To increase accuracy of the sampling, use a catching pen, do not randomly pick up and weigh birds. Place catching frames at set locations across the barn – front, middle and back. Weekly sample weights must be representative of the whole house. Do not place a catch frame near the main hopper area because birds in this area tend to weigh above average from eating feed from the hopper. Forcing birds into the pen or selectively catching birds and placing them in a pen can result in a non-representative flock sample for weighing. Instead, the catch frame should be placed to allow the birds to freely enter the pen for a more representative sample of the flock. Weigh every bird individually inside the catch pen, including small birds, and do not reject any weights, except for sexing errors. After each bird is weighed, release the bird into the house. Continue weighing until the pen is empty.

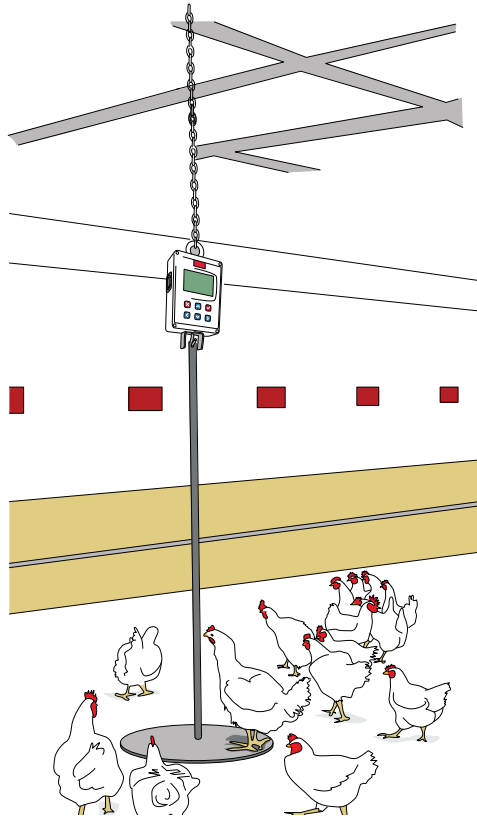

An illustration of a suspended platform style of automatic scales.

Record each weight and calculate the average weight as well as the flock weight distribution. Plot the average bodyweight on the appropriate chart and use this data to calculate the feed amount for the following days. It is also important to determine if the feeding program is working and keeping the birds close to the standard bodyweight.

8.2 Automatic Weighing

Automatic scales are becoming more popular with improved weighing equipment and software. They can be used daily and over a specific time period each day. Typically, measurements are taken for 1 to 2 hour(s) prior to feeding. As an example: if the lights turn on at 7 AM, then scales operate from 7 to 8 AM or 9 AM with feeding starting at either 8:01 or 9:01 AM.

On average, 100 females will step on the scale per hour. The automatic scales are either a suspended or fixed platform, but there is no clear advantage for either. The scale range is normally set between +/- 25 to 30 % of the population mean bodyweight.

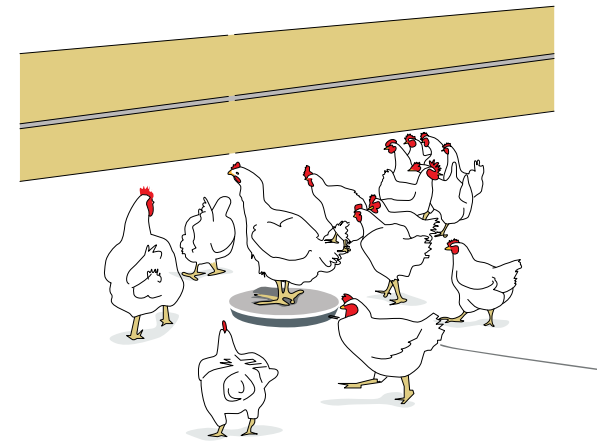

An illustration of a fixed style of automatic scales.



Animal Welfare Tips

If weighing birds by hand with a hanging scale, birds should be securely suspended by both legs (any age) or both wings (preferably only birds that are >11 to 12 weeks of age when the skeletal structure is fully developed). Birds should be kept calm (no flapping and minimal movement) so that weighing can be completed quickly and efficiently. Upon completion of weighing, the bird should be carefully placed on the litter and not dropped directly from the suspended scale.

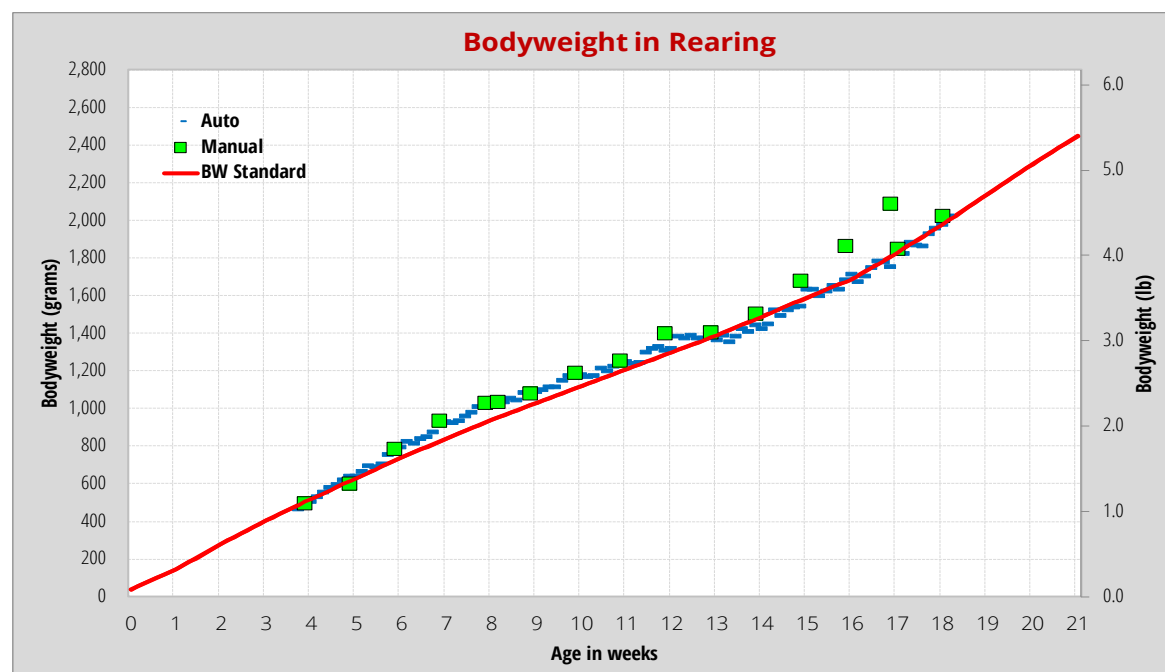

Example of automatic daily (blue) and weekly hand weighing (green) data.

In the graph above, the daily, automatic weighing data (blue dots) consistently follow the weekly bodyweight standard. At 16 and 17 weeks of age, hand weighing (green dots) was done near the main feed hopper and the bodyweight increased compared with the fixed position of the auto scale. The differences in bodyweight were corrected when the hand weighing was done near the auto scale. This is a clear example how location changes in hand weighing can cause misguided average bodyweights that result in changes in the feeding program, potentially affecting conditioning of the females. This is particularly important for flocks between 16 and 20 weeks of age when a fixed development schedule is required to get the females in the right condition at 20 weeks of age.

Advantages of automatic scales:

- ✓ Daily weights available and graphically represented. Most modern house controllers have software for collection and analysis of bodyweight data.
- ✓ Many suppliers offer stand-alone computer systems which can collect data from up to 8 scales located among several houses.
- ✓ Ideal for houses without pens.
- ✓ Quick response to any deviations from the standard – indication of possible feeding equipment or distribution problems.
- ✓ Data is more consistent compared with hand weighing.
- ✓ Less labor – an advantage in terms of biosecurity and labor cost.
- ✓ If using pens, calculate weighted average uniformity.

Disadvantages of automatic scales:

- ✓ Not suitable for weighing males.
- ✓ Scale placement in production is important to prevent weighing a mix of male and female breeders. Scale placement on the slats will give a better representation of female weights.
- ✓ Less bird handling with automated scale systems can increase nervousness in a flock.
- ✓ Auto scales can be used until 30 to 35 weeks of age with good accuracy. After peak production heavier females tend to avoid scales.
- ✓ Will require personnel familiar with data collection, analyzing and computing technology.

Uniformity

Uniformity is a measure of the variability of bird weight in a flock and is measured by weight +/- 10 % of the average bodyweight and/or by coefficient of variation.

To calculate flock uniformity

1. Count the number of birds that are in the 10 % range on either side of the average bodyweight of the 100-bird sample.
2. Subtract the total number of birds that are outside the 10 % range from the 100 birds sampled. This number is expressed as flock uniformity percentage.

Using the data from the previous page as an example:

6 birds (+ 10 %) + 4 birds (- 10 %) = 10 birds total outside the 10 % range

100 birds sampled - 10 birds total outside the 10 % range = 90 % uniformity

% Uniformity	Coefficient of variation CV (%)	Evaluation
95	5	Uniform
90	6	
85	7	
79	8	Average
73	9	
68	10	
64	11	Poor Uniformity
58	12	
56	13	
52	14	
50	15	
47	16	

8.4 Maintaining Good Uniformity

A uniform parent breeder flock will be easier to manage and will produce more chicks per hen housed than an uneven flock. Good uniformity results from careful attention to detail.

Common factors leading to bodyweight uniformity problems

- ✓ Mixing day old chicks sourced from parents with extreme age differences
- ✓ Incorrect nipples for bird age
- ✓ Insufficient water supply or availability
- ✓ Beak conditioning, if not performed at a high standard
- ✓ Incorrect feeding space, feed amounts or poor feed distribution (feed not making a complete loop)
- ✓ Too high or too low energy feeds and not balanced with protein and amino acid profile
- ✓ Incorrect or variable pellet size
- ✓ Incorrect feeder height
- ✓ Irregular feeding times (always feed at the same time)
- ✓ Fast feed cleanup time (less than 30 minutes)
- ✓ Poor ventilation and extreme temperatures
- ✓ Poor lighting (distribution or uniformity)
- ✓ Over stocking
- ✓ Uneven bird distribution over the length of the house
- ✓ Incorrect bird numbers or pen drift
- ✓ Disease or parasitic infections

8.5 Troubleshooting Bodyweight Control

There will be occasions when flocks are not on the bodyweight target. Any corrective actions should be done with long term rather than short term goals. Adjustments to the growth rate of the flock must ensure that the females will still achieve the necessary body condition and weight gains to allow them to not only sexually mature but also maximize peak production and persist for the life of the flock. Adjustments in feed allocations take several days to be realized as change in flock weight. Prevent frequent feed change that creates a jagged growth curve. The following examples illustrate the way in which corrective action should be taken in four different situations:

Flock weight off target at 5 weeks

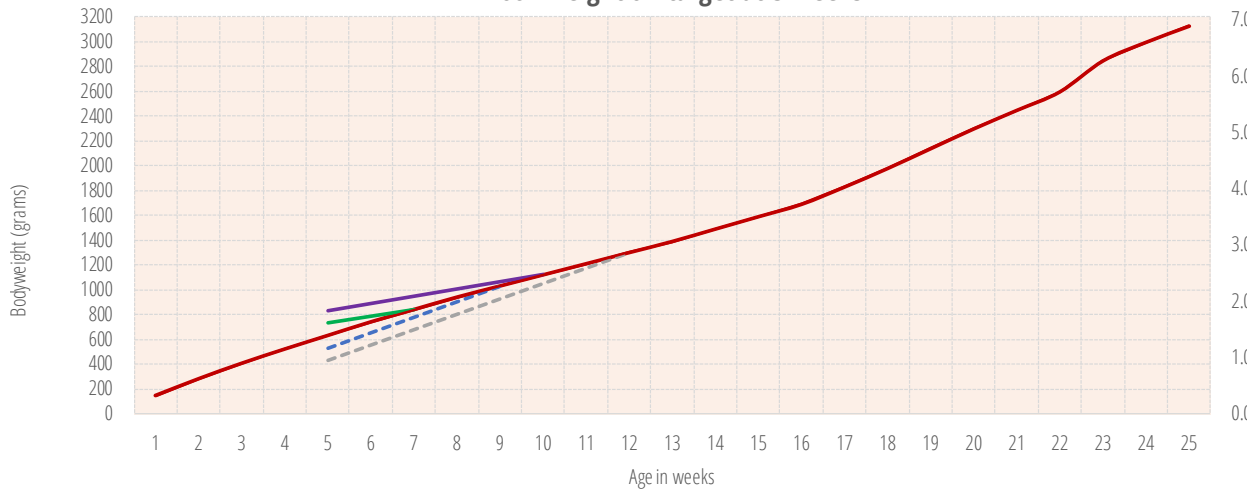

Flock weight off target at 5 weeks

- Problem** - Birds 100 g (0.22 lb) or less under weight.
- Action** - Redraw target bodyweight to gradually achieve standard target by 63 days (9 weeks) of age.
- Problem** - Birds are more than 100 g (0.22 lb) under weight.
- Action** - Redraw target bodyweight to gradually achieve standard target by 84 days (12 weeks) of age.
- Problem** - Birds are over weight by less than 100 g (0.25 lb).
- Action** - Redraw target bodyweight to gradually achieve standard target by 8 weeks of age.
- Problem** - Birds are over weight by more than 100 g (0.25 lb).
- Action** - Redraw target bodyweight to gradually achieve standard target by 70 days (10 weeks) of age.

Flock weight off target after 10 weeks

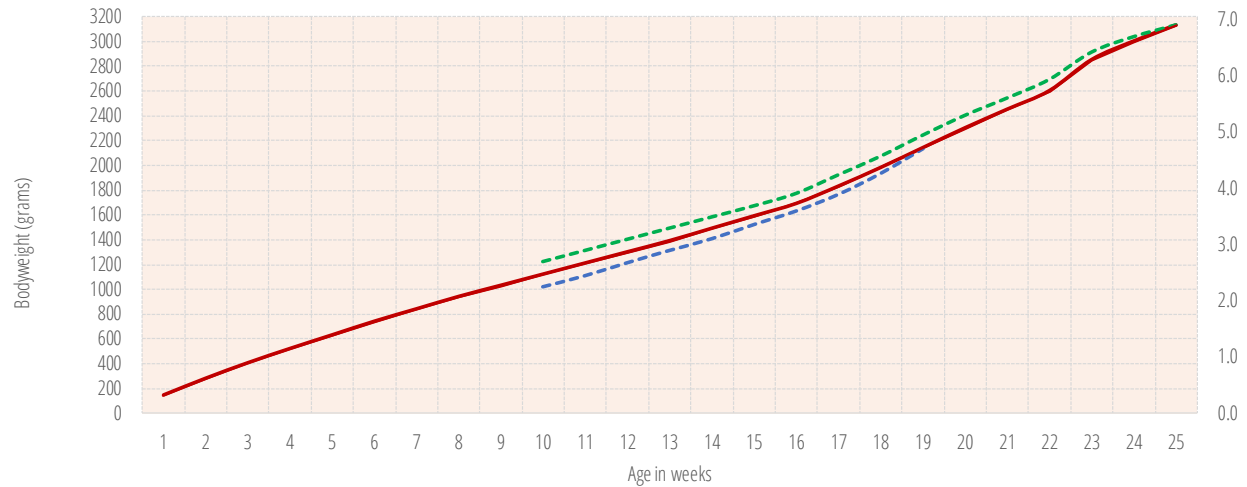

Flock weight off target at 10 weeks

- Problem** - Birds are 100 g (0.22 lb) under weight.
- Action** - Redraw target bodyweight to gradually achieve standard target by 16 weeks of age.
- Problem** - Birds are over weight 100 g (0.22 lb).
- Action** - Redraw target bodyweight parallel to standard target weights through 21 weeks. Bodyweight should return to standard by 25 weeks of age.

Flock weight off target at 15 weeks

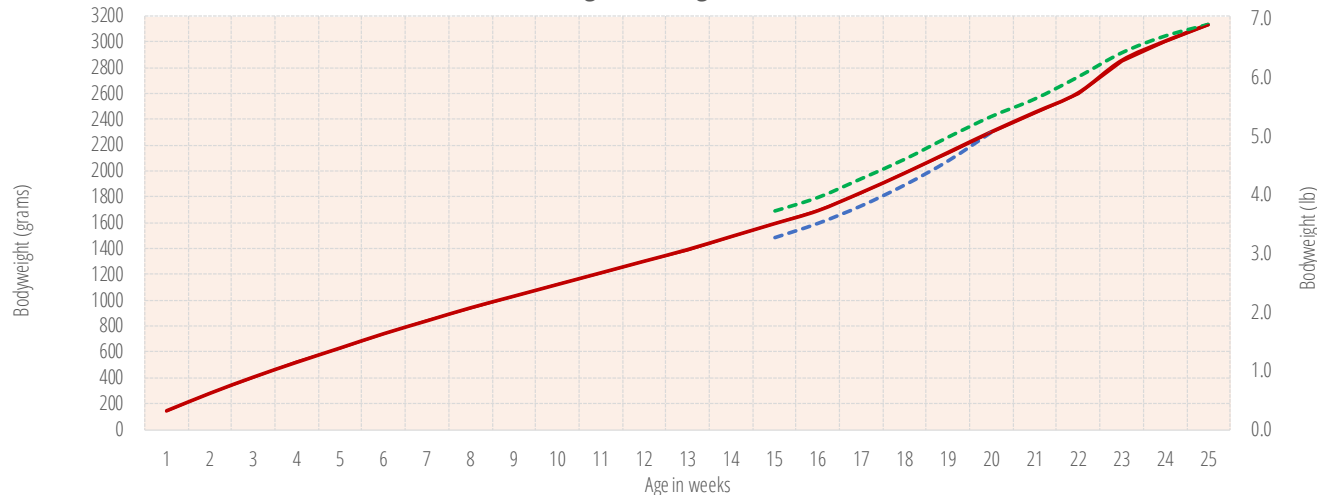

Flock weight off target at 15 weeks

Problem - Birds are 100 g (0.22 lb) under weight.

Action - Redraw target bodyweight to gradually achieve standard target by 133 to 140 days (19 to 20 weeks) of age.

Problem - Birds are over weight 100 g (0.25 lb).

Action - Redraw target bodyweight parallel to standard targets weights through 22 weeks.

Flock weight off target at 20 weeks

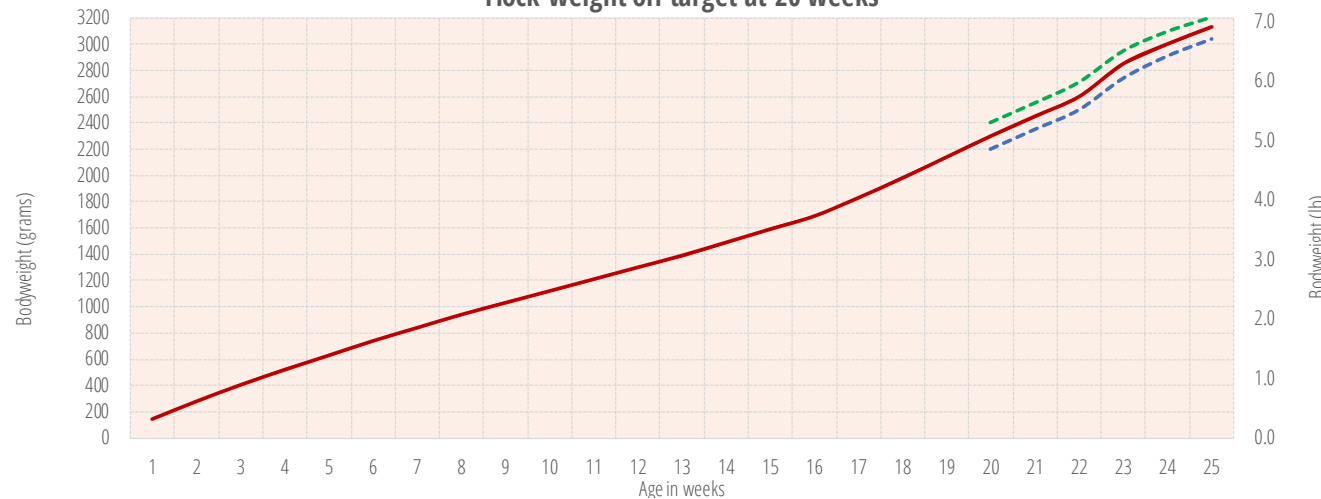

Flock weight off target at 20 weeks

Problem - Birds are 100 g (0.22 lb) under weight.

Action - Delay photo stimulation by 1 week. Redraw target bodyweight parallel to standard target until 5 % daily production, thereafter bodyweight will progress in response to feed increases for production.

Problem - Birds are over weight 100 g (0.25 lb).

Action - Redraw target bodyweight parallel to standard target weights throughout.

9

Methods for Grading Breeders

It is very important to have the flock at the correct weight and uniformity by 4 weeks with a maximum of 5 % above or below the standard. Correct weights and high uniformity at 4 weeks of age will prevent severe feed restrictions or increasing feed amounts during the maintenance period. An important tool to improve uniformity is grading. Grading is the process of sorting individual birds into categories based on bodyweight (super light, light, average, heavy) so that birds within respective categories can be managed back to standard. Sorting birds into categories can be done after taking individual weights and calculating uniformity, CV and standard deviations.

Perform a 100 % weighing and grading when the flock is 7 to 14 days old. This allows the birds to be grouped by weights and feed consumption, which controls competition for feed from a very early age. The subsequent 100 % flock gradings should take place at 4, 8 and 12 weeks of age or when uniformity is below 65 %. Birds should be classified in heavy, medium and lightweight compared to the average weight. Do not delay grading ages or the advantage obtained in the first grading will be diminished. It may be helpful to evaluate the results of grading performed at an earlier age, for example, at 3, 7 and 11 weeks of age. It is clear that if gradings are performed early, it is possible to obtain and maintain uniformity equal to or greater than 80 %. In some regions, the cost of labor prohibits multiple gradings. In these markets, if only 1 grading can be done, the best age is between 21 and 28 days of age. Performing a grading at this age will provide more time to correct any uniformity issues.

Regardless of the number of gradings done in rearing, it is very important to have the basic management criteria correct including: enough feeder space, fast feed distribution (in the dark), good bird distribution over the whole house, constant feed increases on a weekly basis and enough drinking water available with the correct water pressure. Males follow the same grading concept as females and, in general, should be 5 % higher in uniformity than the females. Males represent only 10 % of the flock but are responsible for 50 % of the offspring.

Field results of uniformity curves with and without grading

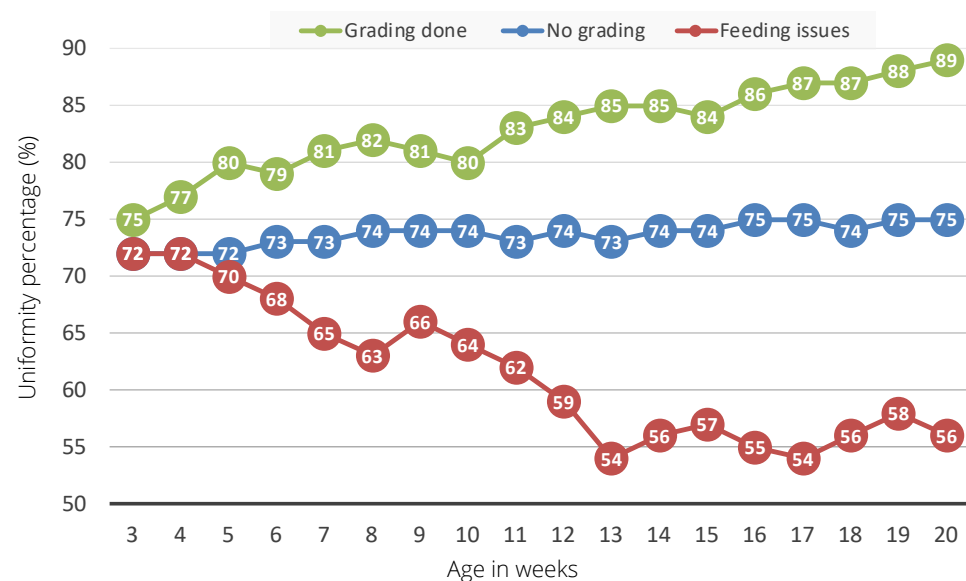

The average minimum uniformity in rearing should be above 70 % (± 10 % variation of the mean) from 3 to 20 weeks. This uniformity should be maintained fairly constant or should increase towards the end of the rearing period. Uniformity below 70 % indicates there are feed intake issues and the flock is not uniform. Being present at feeding is one of the most important times of the day. It is then that errors can be identified, and immediate adjustments can be made so that the flock continues to grow uniformly.

Automatic grading machines

There are a range of models on the market. A larger model is available and is suitable for companies with flocks of more than 300,000. This machine can vaccinate pullets but is not easy to move. In contrast, other smaller models are readily mobile and constructed of stainless steel for easy cleaning. These smaller models are limited to grading chicks and birds up to 20 weeks of age. In general, grading with machines is recommended for 2 gradings at 3 to 4 and 10 to 12 weeks of age, to maintain average uniformity in rearing well above 75%.

Advantages of automatic grading include:

- ✓ Can be faster than hand grading and typically requires less personnel
- ✓ Capacity based on models can grade from 1500 to 3000 birds per hour
- ✓ Sorts birds with exact weight ranges and no mistakes with counting birds that are sorted into groups (a main issue of hand grading)

If more information is needed, contact your Cobb representative to get information on the latest developments.

Weighing and grading by hand

Digital hanging scales are available for grading by hand. Many digital scales can record and store weights to the nearest gram, calculate an average weight, and display histograms of the weight distributions.

The cutoff values for sorting the flock into groups can be programmed to make weighing and sorting faster and easier. Finally, digital scales can also count the number of birds that were weighed and the final number of birds in each group can be displayed on the scale. It is important to note that, if the number of birds in each group is not accurate, then the feed allocations cannot be accurately calculated.

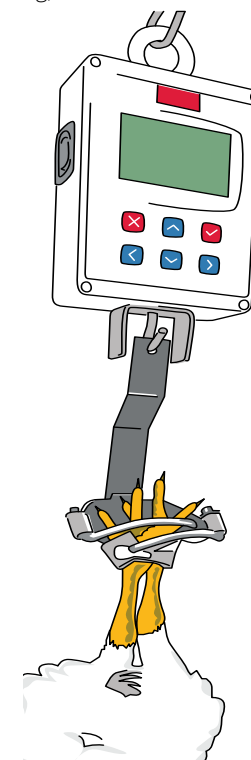

Grading procedure

Cobb recommends sorting birds into 3 groups: heavy, average, and light. Depending on uniformity and CV, a 4th group (super light) can be used.

Some houses have fixed pens or partitions, and in these houses, at least one pen should be left empty at placement for the sorting process. **It is important to remember that if birds are moved to an empty pen during sorting to transfer some of the litter from the used pen to the unused pen to facilitate the cycling of the coccidia vaccine.** If fixed pen or partitions are being used, the size of the pen should be used to calculate the maximum number of birds per pen based on floor, feeder and drinker space. Likewise, for adjustable pens and partitions, adjust the size of these areas based on floor, feeder, and drinker space required for each bird. If floor, drinker and feeder space is not adjusted to meet bird requirements within the pens, sorting birds can actually cause more problems!

Stocking density is important for welfare and uniformity reasons. If pen density levels are too high, uniformity can diminish. In some settings where labor is readily available, multiple small pens can be prepared. In this case, it is recommended that the number of birds per pen not exceed 1,000 birds with 600 to 800 birds per pen being ideal. In houses with 8,000 to 10,000 birds, small pens are not practical.

Each pen should have an independent feeding system. If this is not possible, supplementary feeders can be used to adjust the feed allocations to each pen.

Grading and sorting process

1. Prior to grading, a portion the flock (3 to 5 %) should be weighed. (It is recommended to collect a sample weight even if automatic scales are being used). Determine the average, standard deviation and CV or uniformity (see page 78). There are two ways to determine the sorting weights:

A. Use standard deviation as a cutoff. In this way, 68 % of the flock will be placed in the average category, and the light group (- 1 SD) will contain 16 % of the flock. The remaining 16 % of the flock will be + 1 SD and belong to the heavy group. For example, if there are 3,000 birds in a flock, 2000 would be average weight, while 500 would be light and 500 would be heavy. This approach works with all flocks but can be very effective for flocks with poor uniformity. Normally, under good management conditions and without gradings the uniformity will be around 70 to 72 %. Therefore, working with +/- 1 SD will be more natural for flock uniformity.

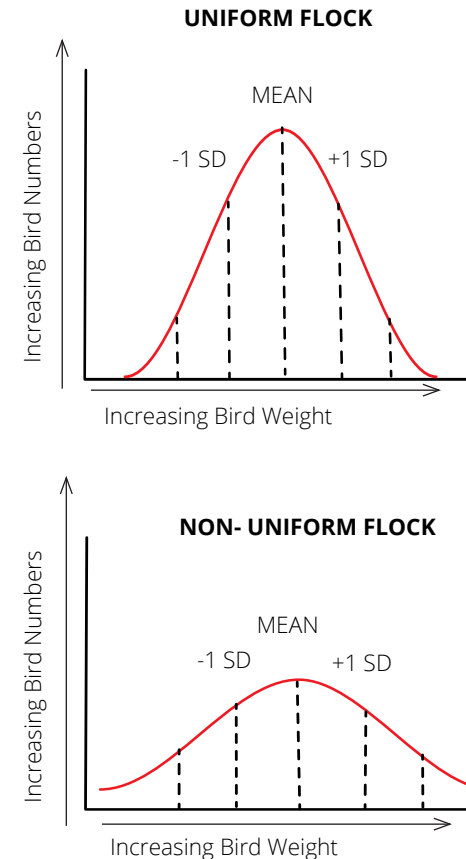

Examples of uniformity curves. In the top curve, the weights are very similar among the birds in the uniform flock. In the bottom curve, uniformity is poor, and the weights of the birds are widely variable among the population.

B. Using a plus or minus 10 % calculation can also be used to grade and sort birds into groups according to the table (right).

2. After the cutoff value has been calculated. Each bird should be weighed and sorted into the correct group (see diagram below). Digital scales can be used to program cutoff values for each group to make sorting faster and easier. The scales can also count the number of birds being sorted into each group.

3. If hand weighing, re-weigh a sample of birds from each pen after sorting. Calculate average bodyweight, the variation (CV), and uniformity. Use this data to determine adjustments to feed allocations to bring the bodyweight back to the target. It is also a good practice to recount the birds per pen to be sure the correct number of birds get the correct feed allocation after grading. Wrong bird numbers per pen are considered one of the major errors seen with hand weighing.

Weight category	Compared to average weight	Example (average weight of 200 g)
Heavy	More than 10 % of average weight	>220
Average	Between +/- 10 % of average weight	220 to 180
Light weight	Less than 10 % of average weight	<180
Super light weight	Less than 20 % of average weight	<160

Flock management after grading

Calculate feed allocations for each group based on number of birds and average bodyweight to bring bodyweight back on target (see bodyweight correction curves in chapter 8).

- ✓ Feed allocations should never be reduced!
- ✓ Any increases in feed amounts should be done conservatively. Keep in mind, that it may not be necessary to increase feed amounts as competition for feed will be reduced after sorting the flock.
- ✓ Continue monitoring bodyweights with weekly weighing.

Competition for feed is always present throughout the birds' lives. As noted, weight grading at an early age enhances management of feed consumption by separating the flock into specific weight categories and feeding back to standard bodyweight. Within sorted groups, it is common to see uniformity above 90 % after grading. However, soon after grading, expect uniformity to decline to a typical level of 70 % to 72 % as pecking (social) order and feed competition become re-established within sorted pens.

If after the first sorting, uniformity of the population across all pens drops to 65 % or below, an additional sorting and grading should be performed. In addition, determine why the uniformity continues to decrease. Normally feed management issues are involved. A crop check can also help determine poor uniformity causes. Some producers perform multiple grading and sortings during rearing as part of a standard protocol. For subsequent grading and sortings, follow the same protocol as described.

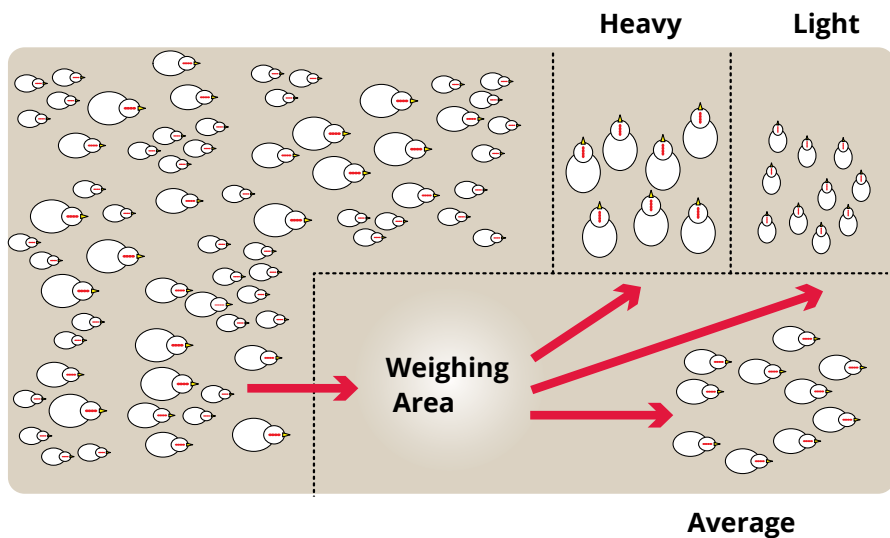

Male Breeder Management

The key to obtaining good hatchability from today's broiler breeders is to develop feeding and management programs that allow a correct development of the male's reproductive system while controlling their growth potential and capacity to deposit breast muscle. The male growth profile is the single most important factor that correlates with flock fertility. Males should be weighed at least weekly from one to 30 weeks of age and at least every other week thereafter.

10.1 Male Rearing

A good start when rearing males is crucial for weight uniformity as well as good organ and skeletal development, which are correlated with future male fertility. It is important that the males achieve bodyweight targets according to the Cobb standard. For best results, the males should be reared separately from the females until housing at around 20 weeks of age.



Male frame size is strongly influenced by the bodyweight growth curve over the rearing period, with most frame development occurring in the first 12 weeks. The 7-day bodyweight target for males is 145 to 150 g (0.32 to 0.33 lb) on *ad libitum* feed but monitor average daily feed intake per bird. Separate the heaviest and lightest males at 3 to 4 weeks. Attempt to get these males back on standard bodyweight by 8 weeks of age. Grading males is more important than females, but male bodyweight can be overlooked. Controlling the bodyweight gain from 12 (puberty) to 20 weeks will help to prevent oversized males and control their sexual development.

Male density in rearing should be around 3.6 to 4.3 males/m² (2.5 to 3.0 ft²/male). Apply beak conditioning in the hatchery. At 8 weeks of age, handle all males and remove any with obvious visual (phenotypic) faults that do not meet quality standards, including crooked or bent toes, skeletal abnormalities, and beak abnormalities.

Maintaining male uniformity

From 16 to 20 weeks the social order is established, and male flocks tend to lose uniformity quickly. At 16 weeks, in order to break the social order and recover uniformity with the lighter males, consider an additional fleshing grading. Separate all the males that have a fleshing of 2 or lower and adjust the feed to increase fleshing scores to 2.5 by 20 weeks of age. At 20 to 21 weeks of age the male and female flocks will be mixed and the social order is changed again. Consider using automatic grading machines to grade males. It is quicker and often more exact.

10.2 Transferring Males to Production Houses

For males reared in environmentally controlled houses it is a good practice to transfer males to the production house 2 to 3 days earlier than the females to help familiarize the males with their feeder system. This will reduce males stealing female feed and improve bodyweight control.

The male to female ratio will depend on sexual synchronization and breed of males. In general, at transfer, select enough males for a female/male ratio of 8 to 9 % in houses with slats, and 9 to 10 % in houses without slats. Select only healthy males for the initial matings. These males should have the ideal bodyweight and body condition. Any males that have quality defects (developmental, skeletal, etc.), are extremely or severely overweight should not be transferred and should be removed and humanely euthanized. Keep the remaining average weight population and moderately heavy males for future use in spiking programs. In floor operations a somewhat larger male can be used if the breast muscle is not oversized, which can create stability and fertility problems.

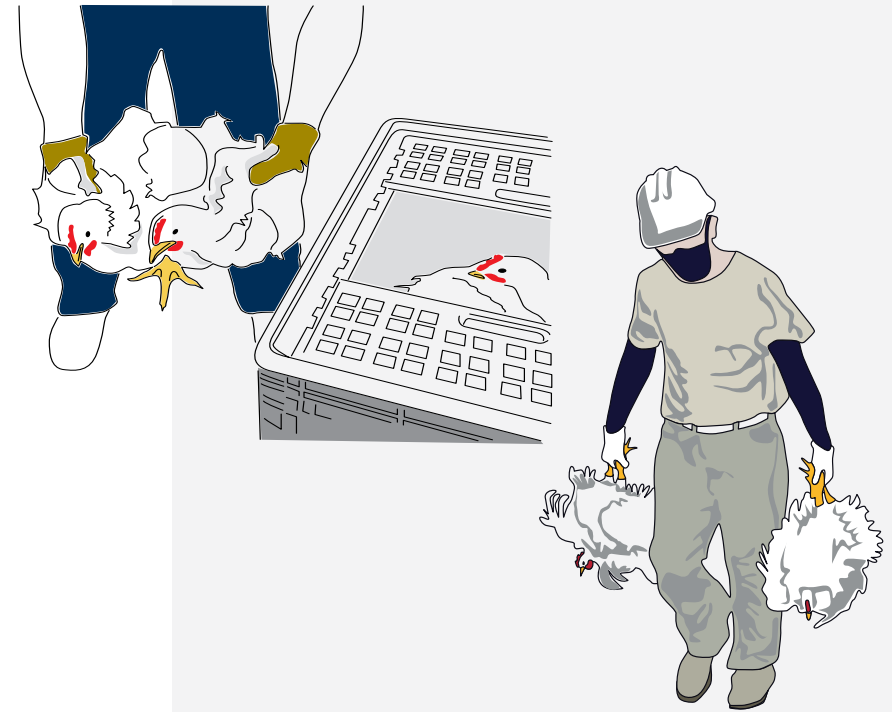

When catching by the back, gently grasp the birds by the sides, making sure wings are secure against the bird's body and wrap fingers on the sides of the bird's breasts. Place the birds into the coops, keeping the wings secured to prevent wing damage. When catching by the feet, catchers should grab birds by the feet only and not the drumsticks to prevent bruising of the hock areas of the legs. Birds must never be lifted, carried, or dragged by the wing, one leg, or neck. Birds must never be thrown. Catching must be conducted in a manner that minimizes bird stress and does not cause bird injury. If coops are used (as shown in the illustration), care must be taken to prevent bird injury. Sliding coops along the floor may cause toe injuries. Take care when closing the top or lid of the coop to ensure that the heads and wings are not caught when the container is closed.



Animal Welfare Tips

Hierarchy in a chicken flock often involves larger, more dominant males at the top of the social order. These top males are not only larger (weight and fleshing) but tend to be socially dominant with their behavior. This is particularly apparent during feeding time. Observing flock behavior, evaluating breast fleshing, and assessing wing resistance on males from 16 to 20 weeks are important to maintain uniformity and to optimize welfare and future fertility outcomes for all males. By grading males and breaking the social order, the smaller and more timid males are provided with the opportunity to grow and develop with additional feed and will have less hierarchical pressure from the more dominant males.

Managing males that exhibit domination (aggressive) behaviors

Poor sexual synchronization is the primary reason for displays of overt male dominance behavior (aggression). These females tend to start production at 25 weeks while males are already exhibiting mating behavior at 23 to 24 weeks of age.

To control and prevent male dominant (aggressive) behaviors

- ✓ Males can be transferred a few days after females if they are considerably ahead of the females in terms of sexual maturity. This will give the females extra time to mature, but males will need an additional week to acclimate to a house after transfer with females already present.
- ✓ Reduce the male ratio to 5 % and keep the remaining males in darker house conditions.
- ✓ Gradually introduce males after start of production (> 10 %) and gradually increase the male ratio by 1 % per week thereafter.
- ✓ For future flocks consider how to improve sexual synchronization by evaluating means to correct the male bodyweight curve from 12 to 20 weeks of age. For example, strictly control male bodyweight in the first 4 weeks to prevent males from becoming oversized at 12 to 20 weeks.
- ✓ Photo stimulate the males at the same time as the females – do not pre-light the males.
- ✓ Oversized males (long shanks) will need more bodyweight to attain the correct condition after 16 weeks of age which can further increase the bodyweight gap with the females.
- ✓ If males are being reared on higher light intensity (10 lux; 1 fc), reduce intensity to 5 lux (0.5 fc) to help slow down sexual maturation during rearing and optimize sexual synchronization with females.
- ✓ If males are transferred early to the production house maintain the same light intensity used in rearing. However, early transfer can delay male sexual development and comb size allowing them to steal feed from the female feeder.
- ✓ Prevent delays in production start with a goal of attaining 1 to 3 % production at 24 weeks. The longer the females delay the start of egg production, the more aggressive the males may be.



Males and females should be distributed around the house (as seen in the photo). When males exhibit dominant behavior, the hens congregate in the scratch area surrounded by males or stay on the slats which will negatively affect the fertility.



Key Point

Any severe stress or drop in bodyweight, or even stagnation of growth from 16 to 22 weeks of age, will result in underdeveloped and less uniform testes in the males and result in lower initial hatches and possible fertility challenges throughout the production period.

Managing weight differences between males and females

Examples of ideal bodyweight in terms of fertility and hatch in Cobb Fast Feather females when mixed with Cobb MV males							
Weeks	Bodyweight females (Cobb 500 FF)		Bodyweight males (MV Male)		% Difference	% Fertility	% Hatch
	g	lb	g	lb			
20	2300	5.07	2795	6.16	22		
25	3130	6.90	3675	8.10	17	90.5	77.2
30	3600	7.94	4185	9.23	16	96.0	86.4
40	3900	8.60	4565	10.06	17	96.5	89.0
50	4095	9.03	4765	10.51	16	95.0	85.1
60	4210	9.28	4915	10.84	17	90.8	80.1

Over the last 10 years, the bodyweight differential between males and females has been reduced considerably, enhancing both fertility and hatchability levels. The table (left) is an example, at different ages, of what the ideal bodyweight differential is between males and females. The table also includes estimates for fertility and hatchability rates when these values are achieved.

High fertility indicates a good balance between testicular development (size and vascularization) and male mating ability. Heavy males can have excellent

testicle size but if they cannot complete more than 75 % of the tentative matings there will be a decline in fertility. Maintain male condition by maintaining a fleshing score between 2.0 and 3.0 during the production period. Using primary males that are 11 to 12 % heavier than females provides:

- ✓ Reduced mortality and culling due to fewer leg, toe or bumblefoot problems.
- ✓ Fast and easier mating allowing females to retain feather cover on their backs.
- ✓ Females are more receptive to mating, resulting in higher fertility rates.
- ✓ Reduces bodyweight differential between the primary and spike males, which improves male spiking success.

10.3 Male Fleshing or Breast Conformation

Fleshing of males in production is not common but has some unique advantages that can help to establish the correct bodyweight profile in production. The Cobb male fleshing spreadsheet is a tool used to record fleshing values from 1 to 5 (example above). The user inputs fleshing scores for the sample population and the spreadsheet calculates percentages and the corresponding weighted average for each group. The weighted average flesh score will be graphically displayed along with the bodyweight. Contact your Cobb Technical Representative for an electronic copy of this spreadsheet.

Age	Crude numbers (Fleshing Scores)							Weighted average fleshing scoring						Real	BW	Fleshing	Hatch/Fert.	Feed	2700	11.25	12.7		
	1	2	2.5	3	4	5	Total	1	2	2.5	3	4	5	Average	BW	Std	Std	Real	g	kcal	MJ	Prot	
20															2900	2795	2.54						
21																2925	2.55						
22																3105	2.56	Dry BW					
23																3395	2.57	Wet BW					
24																3535	2.58						



A good example of a 2.5 to 3 fleshing score during the production period - the keel is still visible and the male is not over fleshed. Due to mating each day, feather wear along the keel is commonly seen in active, healthy roosters. The pink breast skin color is normal and indicates a male with good libido and a very active mating pattern.



A good example of the coloring of the comb, wattles and area around the eyes indicative of a sexually active male. This is one of the first signs to look for when entering a breeder house during the production phase.

Explanation of male fleshing scores

FLESHING 1

Severely under conditioned breast and very thin. No wing resistance. Unacceptable male.



Not Acceptable

FLESHING 2

Thin breast from top (wing area) down. More keel bone exposed. Flaccid wing resistance.



Lean

FLESHING 2.5

V shaped breast with more fleshing in upper breast part near the wings. Stronger wing resistance and minimum condition for most males for good fertility.



Ok

FLESHING 3

More rounded breast with more breast deposition on the side of the keel. (Similar to fleshing 2.5, fleshing 3 is good and preferred for males during the production period.)



Ok

FLESHING 4

Wide breast on top (wing area) and down to end of the keel. This condition will become more noticeable after 50 weeks.



Too Heavy

FLESHING 5

Very wide breast (dimple in keel area). Severely over fleshed male for all the male lines. Fertility would be negatively affected.



Excessive

10.4 Male Feeding - Separate Sex Feeding

One challenge for the farm manager and the feeding system selected is to distribute a small amount of feed per male as uniformly as possible and keep all males with a uniform growth and activity level.

For males, use 20 cm (7 7/8 in) of feeder space with a track system, 8 to 10 males per round feeder and 10 to 12 males with an oval pan feeder. The height of the feeder system is important for all the males to eat comfortably. Normally apply a height that is close to the upper crop height of the males. A measuring stick that is fixed to the male feeder line can help to drop, each day, the feeder line to the correct height so that all males can access the pan feeders without female interference. There are many other tools to keep the height of the male feeders correct. A limit switch may be attached to the feeder line so that it is activated when the feeder line reaches the predetermined height when lowered.

Keep the male feeder at a height that makes the males stretch slightly to eat and prevents the females from reaching. A male feeder should always be stable and not be allowed to swing. The height needs to be frequently adjusted by observing feeding behavior at least once a week up to 30 weeks of age. Chain or mechanical trough feeders are becoming more popular than pan feeders for males. They have some additional advantages including better feed distribution and visibility.

Separate sex feeding (SSF)

It is highly recommended to use Separate Sex Feeding (SSF) in production.

Training the males is key to the success of Separate Sex Feeding (SSF). The males need to quickly identify and use their specific feeders. The best option is to have the same type of male feeder in rearing and production. Alternatively, decoy feeders can be used in rearing. For example, if the males are fed on a chain but will use pans in production, place a few pans in the rearing house and manually add some feed. The males will learn to identify the pans as a feed source. Transfer the males a few days earlier (2 to 5 days) so they are specifically trained to eat from their new feeders before the females arrive to the production house.

After both sexes are in the production house, start the female feeder first and when all females position themselves, lower the male feeder system or start male feed distribution. With feed distribution in the dark, delivering feed can be simultaneous but give females access to their feeders about 1 minute ahead of males.

Separate sex feeding (SSF) allows the use of special male rations. Male diets are widely used in the industry. Furthermore, research and field results confirm that male diets improve fertility. Male rations with lower protein levels (13 %), a 2700 kcal (11.25 MJ/kg) energy level and 0.50 % available lysine, control male bodyweight and breast muscle growth. With specific male rations, it is even more important that the SSF system prevents females from eating out of the male feeder.

True SSF implies that males should not have access to the female feed and vice versa. SSF includes a male exclusion system placed on the female feeder (grill, roller bar, see illustration) and a separate line of pans, trough or tube feeders for the males. The exclusion grill should create both a vertical (60 mm or 2 3/8 in) and horizontal (46 mm or 1 13/16 in) restriction. In systems with a roller bar or wooden board – plank adjust the vertical restriction. Often, planks have three different height settings: 42 mm (1 11/16 in), 46 mm (1 13/16 in) and 50 mm (2 in). Begin at 21 weeks with 42 mm (1 11/16 in), then increase to 46 mm (1 13/16 in) in peak production and finally to 50 mm (2 in) at about 50 weeks of age.

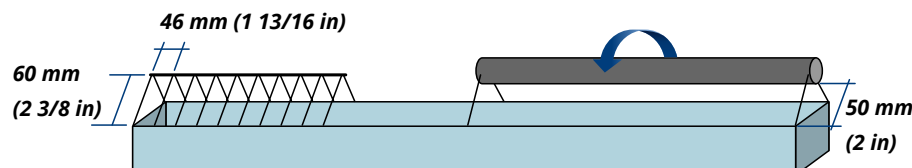

Exclusion systems on a female track feeder - grill on the left and a roller bar on the right.

10.5 Male Weight Trends During Production

The Cobb standard for male bodyweight is designed to keep the male light early in production - not more than 4 kg (8.8 lb) at 30 weeks and have a consistent growth maximum of 25 g (0.06 lb) per week from 30 weeks to depletion (approximately 4.7 kg (10.3 lb) at 60 weeks). Consistent, positive growth during the first 4 weeks after photo stimulation, is important for testes development (see table below).

Guidelines for testicle weights based on age

Age (weeks)	21	22	23	24	26	28
Testes weight (g)	0.5	2	18	24	43	47

Common reasons for poor male fertility related to weight:

- Excessive growth through 30 weeks (4.4 kg; 9.7 lb) and poor growth after 30 weeks due to insufficient feed amounts. In these flocks a number of the males will lose condition.
- Excessive growth through 30 weeks, and bodyweight continuing to increase reaching 5.0 kg (11.0 lb) or higher at 50 weeks of age.

Normal growth through 30 weeks of age but insufficient growth thereafter results in many males losing condition, comb and wattle color. Over fleshed males (> 4 fleshing score) may have reduced mating efficiency due to incomplete mating. As males get too heavy their breast shape flattens, and they become unbalanced when attempting to mate.

Problems will occur if males are able to eat from female feeders after transfer. Males will gain excess weight and will need more energy for bodyweight maintenance. Females will not have enough feed and limit their development. Consider keeping male feed allocations constant until the combs develop to the point that they cannot eat from female feeders. Add the male feed increase to the female feeders until males cannot eat from female feeders.

Male feed amounts and bodyweight

Transfer to 28 weeks	Small feed increases 2 g/week or 0.44 lb/100/week. Larger feed increases are possible based on the male line used. Avoid males with fleshing #1.
28 to 30 weeks	Small amounts of feed should be given to allow slight bodyweight increases which will maintain correct weight gains and keep the males stimulated and active.
After 30 weeks	Feed allocations should be modified according to weight trends – 1 to 2 g/week or 0.22 to 0.44 lb/100/week every 3 to 4 weeks.
35 to 50 weeks	The adult male can be kept very active and in good condition with 330 to 350 Kcal/male/day (1.38 to 1.46 MJ/kg) and 16 to 17 g crude protein/male/day – mash feed.
Notes	The heat treatment process for crumbled feed liberates more carbohydrates and facilitates digestion. As a result, crumbled feed provides about 50 kcal more than mash feed. Therefore, for crumbled feed, calculate about 5 g (1.1 lb/100 birds/week) less feed over the entire production period compared to mash feed. Feed increases are particularly important in slat operations, especially after 40 weeks of age.



Key Point

Males should never lose weight in production. A loss in bodyweight of >100 g may cause a reduction in sperm quality based on the males' condition. Monitor weights weekly and adjust feed accordingly. Normally feed amounts are not decreased in males. However, if after 30 weeks, the male bodyweight increases too fast, reduce the feed by 5 g/male (1.1 lb/100 males/week) and monitor for 3 to 4 weeks until weight gain stabilizes This is one of the most important periods to decrease feed amounts for males as an emergency procedure.

10.6 Spiking Males During Production

Spiking is the addition of young broiler breeder males into an older primary flock to compensate for the decline in fertility that generally occurs post 45 weeks of age. Flock data has repeatedly shown that having a spiking program in place prior to fertility decrease produces the best results. Many times, historical flock data can help guide when a flock should be spiked. For optimal results, the hen flock should be between 35 to 40 weeks of age and spiking can be done with normally scheduled management procedures. Spiking once in the life of the flock is normally sufficient. Flocks spiked twice in an 8 to 10-week interval also produce good results but is dependent on the quality of the primary males. Spiking is usually not economical when the females in the flock are beyond 55 weeks of age.

Incorrect spiking can result in a drop in fertility and hatchability as males attempt to establish a new social hierarchy. Poor spiking management procedures can result in a total loss of the spiked males several weeks after spiking. Carefully record removal of primary males and monitor the remaining primary male ratio so that spike males can then be added at the appropriate time. It is a good practice to eliminate males every week that are unable to mate and keep only the highly productive and active males in the flock.

Spiking can compensate for fertility declines associated with:

- ✓ Decline in mating interest – common after 35 to 40 weeks
- ✓ Reduction in sperm quality - common after 55 weeks
- ✓ Lower mating efficiency due to poorly managed males in poor physical condition. On a daily basis identify and remove birds with mobility issues. Maintain good quality primary males by culling males weekly that are not able to mate. The best results are being achieved when comprehensive male selections are done at 25, 35, 45 and 55 weeks of age.
- ✓ Excessive male mortality resulting in a reduced male to female ratio

Spiking Methods

Option 1	Option 2	Option 3
<p>(Recommended method) Remove all the high quality primary males from a single house or compartment, and intra-spike with the other houses or compartments on the farm. The house with the primary males removed will receive the spiking males. This procedure will not induce competition between primary and spiked males and is a very effective way to preserve and use the spiking males to their full extent (see section on Intra-Spiking for more details).</p>	<p>To each house, add a minimum of 20 % new young males that are at least 25 weeks of age, with bodyweight of approximately 4.0 kg (8.8 lb). This program works well when there is <10 % bodyweight difference between the primary males and the spiking males.</p>	<p>Heavier males are removed from a young parent stock flock at 26 weeks of age. (These males know where to eat and drink and how to mate). Mix these males in a flock with primary males or in a house where primary males were removed. This program is popular in farms that have 100 % floor operations, and higher percentages of males through 26 weeks. Expect to house 10 to 11 % males without dominant male behavior.</p>

Important criteria for effective spiking outcomes

- ✓ Spike males may be transferred to the same facility as the primary males but housed in a pen (3 birds per m²; 3.6 ft² per bird) separate from the flock. Alternatively, use a designated house for rearing spike males to be introduced to 35 to 40-week old hen flocks.
- ✓ When using separate spike male rearing farms, the spiking farms will receive a fixed number of male deliveries for a specific spiking program.
- ✓ Spike with a minimum of 20 % additional males to increase the male ratio back to 9 % if the primary male numbers have been reduced through culling.
- ✓ In production houses without slats, house 9 to 10 % males at transfer. Allow the male to female ratio to decrease to 7.5 % by 40 weeks of age before spiking back to 9 %.
- ✓ Spike males back to 9 % in slatted production houses when the male ratio goes below 7 %.
- ✓ Spiking with an insufficient number of males is generally ineffective due to primary male dominance resulting in high mortality of spike males.
- ✓ Spiked males should always be good quality and free of physical defects. It is common practice to use a heavier bodyweight standard in males if spiking programs will be used. The bodyweight differential between spike males and primary males should be as low as possible to ensure a high success rate.
- ✓ If early spiking is practiced (30 to 32 weeks), then fewer males (7 %) can be placed at 21 to 22 weeks. Over time, more males can be added to increase the male ratio to 9 to 10 %. This decision must be based on housing conditions and levels of dominant male behavior. This method will improve female receptivity and mixing of sexes.
- ✓ A slight feed increase just after spiking 2 to 3 g/bird/day (0.44 to 0.66 lb/100/day) should be beneficial since spiking significantly increases male mating activity.
- ✓ Keeping males in reserve in good condition is challenging. After 23 weeks, the longer they are without females, males will begin to deteriorate. In the holding pens, maintain plenty of drinkers, feeders and barrier enrichments.

Biosecure spiking

- ✓ Biosecurity risk is the main reason some producers choose not to spike.
- ✓ Males should come from a single source flock.
- ✓ The source flock should be tested using a PCR assay for *Mycoplasma* and other diseases as appropriate (Avian Influenza, TRT and environmental *Salmonella*) 5 to 7 days before transfer.
- ✓ Check for parasites (worms and mites) and any signs of disease (fowl cholera).
- ✓ In the case of a positive or suspect result, the move should be delayed.
- ✓ Plan the time and pathway of the move to minimize contact with other poultry.
- ✓ Use an enclosed vehicle to transport birds if possible.

Expected results of spiking

- ✓ Peak fertility response should be seen approximately 2 to 3 weeks after spiking. Generally, spiking should result in a 2 to 3 % increase in overall hatchability.
- ✓ Spiking stimulates mating activity significantly in the primary males and lasts about 6 to 8 weeks.
- ✓ Male dominance and mating interference usually increases for 2 weeks after the introduction of young spike males. Male mortality can increase slightly but not dramatically if the males have the correct bodyweight and condition when added.
- ✓ Spiking does not solve pre-existing problems such as over weight primary males, and poor mixing.
- ✓ Relying on a spiking program could result in poorly managed primary males, which are essentially the most important.

Intra-spiking

- ✓ Intra-spiking involves the exchange of 25 to 30 % of primary males between houses on the same farm, without importing any new young males, to stimulate mating. As with spiking, intra-spiking has better results when done early in the production cycle (<45 weeks). Intra-spiking between 40 and 48 weeks always produces the best results. Mating activity should increase very significantly after intra-spiking and last between 6 and 8 weeks.
- ✓ An advantage is that the males exchanged are already trained in mating and usually have similar weight and maturity as the original males, improving their chances to compete successfully.
- ✓ Intra-spiking increases male dominant behavior for two weeks after mixing as the social order is reestablished. There are usually no problems with male or female mortality.
- ✓ Hatchability does not increase dramatically after intra-spiking, but the persistency of hatchability is improved. With a double intra-spiking procedure, expect an increase between 1 and 1.5 % in the overall hatchability of the flock.
- ✓ Intra-spiking is inexpensive, easy-to-practice and, most importantly, rarely presents a biosecurity risk.

The graph below illustrates the beneficial effects of flock spiking on percentage of hatchability to 60 weeks of age. For this example, a flock spiked at 40 weeks and a flock intra-spiked at 40 and 48 weeks of age are compared to a non-spiked flock. The average flock hatchability for the non-spiked flock was 84.5 % while the intra-spiked flock was 85.8 % and the flock spiked at 40 weeks was highest at 87.4 %.

The impact of male spiking on flock percentage of hatchability

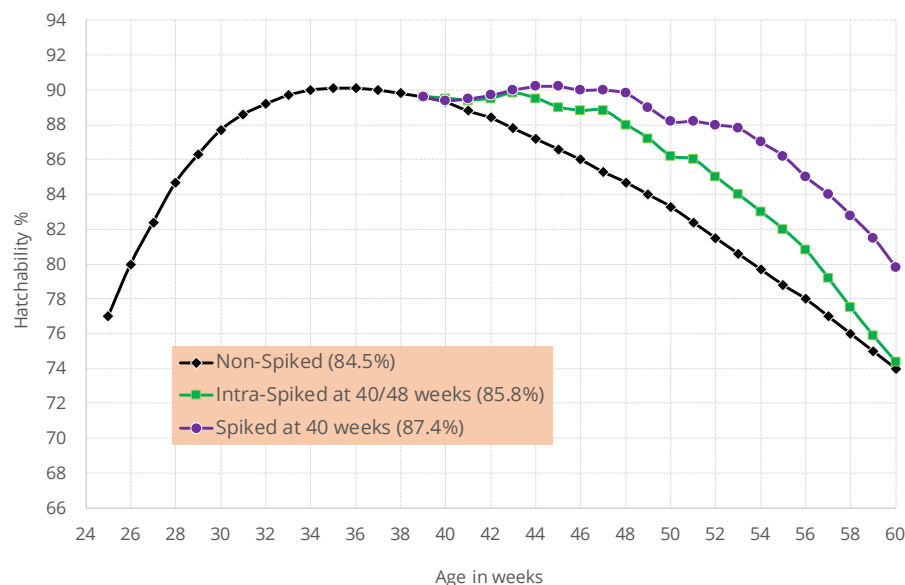

Animal Welfare Tips

To optimize male comfort, behavior and quality during spikes, these recommendations can be considered when planning the transfer:

- ✓ During winter (cold months): if using open-sided trailers, move males during daylight hours with appropriate boards/tarps to prevent exposure to extreme cold weather.
- ✓ During summer (hotter months): move males early in the morning or late evening to prevent thermal stress.
- ✓ If possible, move males in an enclosed trailer to minimize thermal discomfort and to optimize the ability to transfer the males in late evening or early morning when the rest of the flock is likely resting.

Take care when handling the spike males. Staff should handle a maximum of two birds per hand to reduce injury potential to the birds. Ideally, males should be handled by both wings or both legs (depending on welfare guidelines or codes of practice) and should be placed gently on the litter in the new house.

Before the transfer, consider using a food-based dye to mark the new males (intra-spiking or full-spiking). This practice will enable farm staff to easily identify the new males within the breeder flock and to verify that males find water and feed, are adjusting to the house and are mixing with the hens. After 3 to 5 weeks, the dye will fade and males should be fully acclimated to the new house.

11

Record Keeping

Keeping complete and accurate records is an essential part of managing Cobb parent stock. For example, feeding during production is based on the rate-of-lay, egg weight and flock bodyweight. These records must be accurate and up to date in order to make correct management decisions and to achieve good production.

Rearing		Production		
Daily	Weekly	Daily		Weekly
<ul style="list-style-type: none"> ✓ Total mortality ✓ Culls ✓ Feed ✓ Temperature ✓ Water consumption ✓ Feed cleanup time 	<ul style="list-style-type: none"> ✓ Bodyweight ✓ Uniformity ✓ Ventilation settings 	<ul style="list-style-type: none"> ✓ Total mortality ✓ Culls ✓ Feed ✓ Temperature ✓ Water consumption ✓ Feed cleanup time 	<ul style="list-style-type: none"> ✓ Total egg number ✓ Egg weight ✓ Hatching egg number ✓ Floor eggs ✓ Fertility ✓ Egg classifications 	<ul style="list-style-type: none"> ✓ Bodyweight ✓ Uniformity ✓ Fertility at hatch of each house ✓ Male selection ✓ Culling

In addition to individual records per house or per flock, it is important to accumulate the data in a summary template that integrates the basic management procedures with the technical results. Cobb has this summary template in spreadsheet forms for females and males and it is highly recommended to consolidate the data.



↓ Cobb Breeder Management charts are available online under **Resources > Product-Supplements**

12

Egg Handling

12.1 Egg Collection

Maximum hatchability and chick quality can only be achieved when the egg is held under optimum conditions between laying and setting in the incubator. Once laid, its hatching potential can at best be maintained, not improved. If mishandled, hatching potential will quickly deteriorate.

- ✓ Manual nests should be well maintained with clean shavings. Any droppings, broken eggs and soiled material must be removed promptly from the nests and replaced with clean fresh nest material. In early production hens will tend to scratch the shavings out if nests are over filled. Hens prefer to make a concave type nest shape which can be done when shavings are placed inside and will make the nest more inviting for the hens.
- ✓ Frequent walking through the flock after onset of lay (point of lay) is a good management technique to minimize floor eggs. Walking the flock will disturb birds that are looking for nesting sites on the litter or in the corners of the house and encourage them to use the nest boxes.
- ✓ Egg temperatures within the nest, particularly during hot weather, may be similar to those in an incubator. Therefore, eggs must be regularly collected and cooled down to storage temperatures (21 to 25 °C ; 70 to 77 °F) to slow pre-incubation and embryo development. This will reduce embryonic mortality and improve hatchability.
- ✓ Egg collection from mechanical nests should be timed to prevent the risk of pre-incubation. The morning should be used to collect hatching eggs, and the afternoon can be used for house and bird management, as well as repairs/maintenance.
- ✓ Wash hands before and after each egg collection, and before and after handling floor eggs.
- ✓ Hand collect eggs at least four times daily and during peak production periods six collections are recommended.
- ✓ Always handle eggs carefully to prevent cracks. Eggs should be collected in plastic or fiber trays. When carrying by hand, egg trays should be stacked and carried at a maximum of 3 tiers high.
- ✓ Do not use baskets or buckets as they cause cracked and contaminated eggs.
- ✓ With mechanical systems, do not allow eggs to accumulate on collection tables. Adjust the system to a speed that allows egg collectors to work comfortably.
- ✓ In manual nests, when collecting eggs, close the lower nests before the last round of egg collection and leave the upper nests open. At the last collection, close the upper nest to help maintain cleaner nest conditions.
- ✓ With the mechanical community nest, open the nests 1 hour before the lights are turned on and close the nests 12 hours after the lights are turned on.
- ✓ ***Use of floor eggs decreases hatchability and is a hygiene risk. Never put floor eggs into nest boxes. Collect, pack and clearly identify floor eggs separately from nest eggs. If floor eggs will be incubated, they should be incubated and hatched in machines dedicated for floor eggs.***

Automatic egg packers - Key points and considerations

Many large parent stock operations with community nest systems are further automating the farms by connecting the houses with a centralized egg packer.

- ✓ Centralized egg packer machines have a range of hatching egg (HE) collection capacities. A 10,000 HE/hour machine is considered sufficient capacity for a 30,000 to 40,000 parent stock farm. A 15,000 HE/hour machine is regarded as sufficient capacity for a 60,000 to 70,000 parent stock farm.
- ✓ All egg packing work should be completed in around 4 to 5 hours every day. Use the egg packer only once per day to minimize system wear if the egg belts total 50 cm in width and there is a separation between the 2 egg belts. If the egg belts are not separated and are smaller (only 20 cm wide) consider, as a minimum, 2 to 3 egg collections per day to reduce eggshell cracks and micro fractures. In this case, eggs should be packed 2 to 3 times a day and placed directly in the egg storage room.



- ✓ The egg packer machine can place the eggs in a carton or directly on hatchery trays, depending on the level of automation.
- ✓ Ensure the correct egg identification stamps are available, especially for export products.
- ✓ Egg trays (30 to 150 eggs) can be filled on site (egg tray stacking).
- ✓ Egg packers may operate with or without egg tray stacking.
- ✓ Paper egg trays must be dry and stored in a dry room for the easy separation during the packing process.
- ✓ The presence of many small feathers and dirty eggs indicates the nests are not closing or closing too late.
- ✓ Use a good light source (warm light) at the packer to ensure all hairline cracks are removed.
- ✓ Maintenance teams need to lubricate all moving parts on a weekly basis.
- ✓ Work areas should always be kept clean.

Egg collection timing

Egg collection timing given here is shown as an example. Egg belt speeds are adjustable and the manufacturer of the egg collection equipment can provide more information on adjusting egg belt speeds and timing.

The following concept can only be used when the house temperature is below 22 °C (72 °F) to prevent pre-incubation of eggs on the egg belts. Since each house is collected in sequence, the time collection starts in successive houses is delayed by the time necessary to collect the previous house (see illustration below). For example, the furthest house collection starts 7 hours after lights on. The second house will begin collection 45 minutes later with an additional 5 minutes for eggs that are on the belt to move past the next house (i.e. 7 h 50 min after lights on). When the third house starts collecting eggs, the total time from the start of lights turned on is now 8 h and 40 min. For successive houses, close to 100 % of the daily production will be on the belt as a result of the timing.

Normally, eggs in the first and second houses are being collected while production continues. In this case, these houses can still contain up to 10 % of the daily production after the first collection. Therefore, after the first collection from all the houses, a second collection begins with the first and second house. During this second collection, most of the daily egg production should be collected. Since the first house was collected before all eggs were laid, a second round of collection can be done by increasing the belt speed to collect all eggs in 10 to 12 minutes.

An example of egg packer set up and timing

Lights are turned on at **3:00 AM** and belts are turned on 7 hours later beginning with house #1 (furthest from the egg packer).

Egg belt in house #1 is turned on at **10:00 AM**

Egg belt in house #2 is turned on at **10:50 AM**

Egg belt in house #3 is turned on at **11:40 AM**

Egg belt in house #4 is turned on at **12:30 PM**

Egg packer

Location should be in the middle. Here half of an 8-house complex is illustrated

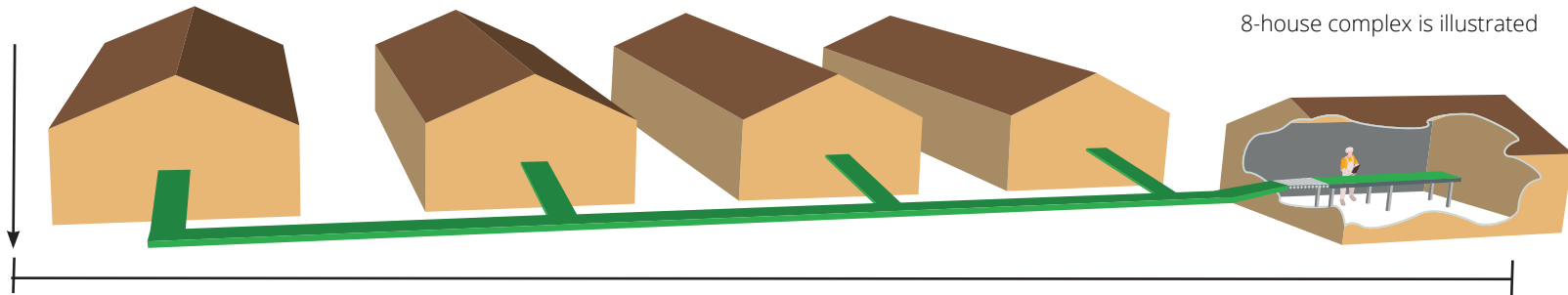

It takes **45 minutes** for all hatching eggs to move from the end of **house #1** to the front of the egg belt with **5 additional minutes** for eggs to move past **house #2**.

90 m (295 ft) in 20 minutes

A camera at the house exit on top of the belt area can be used to visualize when the last eggs pass. Place a large colored egg at the end of the house to indicate that the belt run has completed.

Egg Packer Capacities

- 10,000 HE - 35,000 Hens
- 15,000 HE - 60,000 Hens

Egg belt speeds

- ✓ When the house temperature is below 22 °C (72 °F) (to prevent pre-incubation of eggs on the egg belts) start the egg packer 7 hours after the lights come on and most of the production is on the belt. ***This is only feasible with community nests that have 2 belts of 25 cm (10 in) wide and a separation between the belts to minimize hairline cracks.***
- ✓ Always start collection of the HE with the furthest house. A 100 m (330 ft) long house will require about 45 minutes to bring all the eggs to the connector belt.
- ✓ A 100 m (330 ft) corridor collector belt will require ±20 minutes to bring all the eggs to a central packer when all belts are at a fixed speed.
- ✓ Keep several meters between the last eggs of one house and the first eggs of the following house to track individual house production.
- ✓ Installation of an egg counter at each house belt exit, before the eggs go on the connector belt, is a good practice.
- ✓ After the first collection from all the houses, as second collection begins with the first houses that still have some eggs left on the house belts. During the second collection, most of the daily egg production should be collected (>99 %).
- ✓ In the first 8 hours after the lights come on, more than 90 % of the hatching eggs will have been produced by the birds.

12.2 Egg Weighing

There are considerable advantages in weighing a sample of eggs each day to establish the trend in egg weight. The analysis of this trend is a useful guide for flock performance and will give an early indication of problems.

Egg size is partly determined by the bodyweight of the females at photo stimulation, the development between 21 and 25 weeks of age, and the extent to which females become over weight after peak production. Delays of photo stimulation will result in larger eggs initially and throughout the life of the flock. Eggs over 70 g tend to have a poor hatch and can considerably affect the average hatchability of the flock. This is likely the reason for a more rapid decline in hatch after 50 weeks of age.

The egg weights shown in the Cobb supplements (available at Cobb-Vantress.com) should be expected from normal parent flocks when our recommendations for bodyweight, feed levels and feed specifications are followed. In the egg collection room, bulk weigh at least 90 eggs immediately after the second egg collection, which usually occurs around mid-morning. Make sure to exclude double yolks, misshapen, very small and cracked eggs. Daily egg weights, when plotted on a graph, will give an indication of potential problems that should be investigated immediately.



Please refer to the Breeder Management Supplement for egg weight standards of each product (Cobb 500 fast and slow feathering, and Cobb 700 fast and slow feathering).



Cobb Breeder Management Supplements are available online under **Resources > Product-Supplements**

Automatic egg weighing

Many egg packing machines weigh all the eggs. Regular calibration of the scale is necessary to prevent hatching eggs loss. In first 8 weeks, the maximum weight needs to be adjusted twice weekly to prevent larger eggs being mistaken for double yolks. A 1 g difference in maximum weight can have a large impact. Always set the minimum weight requested by the hatchery.

Managing egg weight

Egg weights are important to maintain in the latter part of the production period as weights impact eggshell quality, hatchability and chick quality. Investigations and field experiences report that eggs over 70 g tend to hatch less and have more late embryonic mortality when not enough cooling is available in the hatchers. **Try to maintain an average egg weight below 70 g for as long as possible!**

Typically, egg weights will increase during production but should be controlled to increases of 1 gram every 2.5 to 3 weeks after 35 weeks of age. Ideally, average egg weight should be close to 70 g between 55 and 60 weeks of age.

The following recommendations can be used to control egg weights:

- ✓ Control female bodyweights into peak production and after peak production. This involves adjusting and optimizing peak feed amounts and reducing the feed after peak correctly.
- ✓ Change from breeder-1 (B-1) to breeder-2 (B-2) feed when the egg weights reach 60 g in Cobb FF and 62 g in Cobb SF. Cobb recommends only B-1 and a B-2 feed be used because, with the proper reduction in feed amounts, the hen weight and egg weights should be controlled.
- ✓ Start production on time. It will take a hen longer to reach a 60 g average egg weight when production begins at 24 weeks compared to 25 weeks. A lower egg weight at 30 weeks indicates, in general, that the egg weight will be lower at 40 and often 50 weeks of age.

Causes of	
Under weight eggs	Over weight eggs
Under feeding	Over feeding
Low energy or protein feeds	High energy or protein feeds
Insufficient water	Over weight hens
Disease	Low production
Extreme house temperatures	
Under weight hens	
High production	



12.3 Egg Hygiene

Under certain conditions, it may be beneficial to sanitize hatching eggs. Peracetic acid can be used as an alternative. Fumigation or disinfection of hatching eggs on the farm should be applied as soon as possible to prevent bacterial penetration before the cuticle matures. Eggs should be treated with chemical-based antimicrobials — scraping, rubbing, or washing the eggshell will damage the cuticle and remove the physical and antimicrobial barrier. **Do not wet hatching eggs with liquid sanitizers. Only under low humidity conditions will this procedure be an acceptable tool to reduce contamination.** Since the eggshell permeability increases after 24 hours and makes the eggs more susceptible to bacterial invasion, the eggs should be sanitized as soon as possible. Thus, if fumigation or disinfection on the farm is not possible, eggs should be sanitized at the hatchery as soon as they are received.

12.4 Egg Grading

Egg grading should be done with care to prevent mechanical damage to hatching eggs. Remove and discard eggs that are unsuitable for hatching including:

- ✓ dirty or stained as defined by company policy
- ✓ cracked
- ✓ small - depending on hatchery policy
- ✓ very large or double yolk
- ✓ poor shell quality
- ✓ grossly misshapen

Important management practices:

- ✓ Rejected eggs should be stored well away from hatching eggs.
- ✓ It is essential to place hatching eggs carefully into the transport tray with the small (pointed) end facing down.
- ✓ The egg handling room must be kept clean and neat.
- ✓ Nest pads in mechanical nests should be kept clean especially with older flocks.
- ✓ Maintain good vermin control in the egg store.
- ✓ The egg handling room is the first stage of egg cooling and it is advantageous to keep it cooler than the laying house, but warmer than the egg storage room.



HATCHING EGG GRADING GUIDE



IDEAL EGG
Clean, free of cracks, correct shape, within acceptable weight range



CALCIUM DEPOSIT



BLOOD STAINED



CRACKED



DIRTY



STAINED



TOE PUNCHED



MEMBRANE

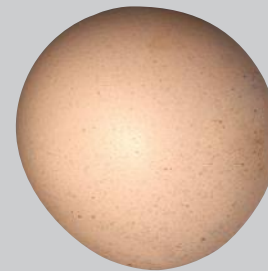

ROUND



SLAB SIDED



SMALL



THIN SHELL



YOLK STAINED



WRINKLED



HAIRLINE CRACK

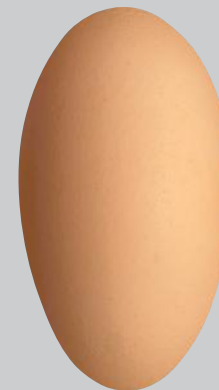

ELONGATED



DOUBLE YOLK

Eggs with defects (described with red text) should be discarded and never incubated

12.5 Eggshell Quality

Almost 50% of discarded eggs are due to shell quality issues. A pale brown or white color can be the first indication of poor eggshell quality for broiler breeders. In pale eggs, it is likely that cuticle deposition and calcium accumulation are decreasing or not complete which could be a result of nutrition and disease. In some cases, eggshell quality issues are due to premature oviposition.

Shell thickness and strength are critical factors and should be monitored over the life of a flock. There are a variety of tests that can evaluate shell quality. Destructive methods include breaking strength, shell weight and thickness. Shell weight and thickness can be readily measured on site. A sample of 30 eggs per flock is recommended. Use relatively clean floor eggs instead of nest eggs since floor eggs are likely to be discarded.

12.6 Egg Storage

Eggs should be allowed to cool down gradually before putting them into egg storage (refer to the Optimum Temperature Range for Egg Storage chart). Store the eggs in an environmentally controlled egg store with a relative humidity of 70 %. For long-term egg storage, refer to Cobb Hatchery Management Guide.

Always keep daily records of the maximum and minimum temperatures and the relative humidity in the egg store. Measurements should be taken three times a day (in the morning, mid-day and in the evening). It is important to take measurements at the same times each day.

Key points on egg storage

- ✓ Eggs should be collected from the farms and transported to the hatchery at least twice a week.
- ✓ There are three storage areas: farm egg room, transport, and hatchery egg room. It is important to match the conditions in each of these situations as closely as possible to prevent sharp changes in temperature and humidity, which can lead to condensation (sweating) on eggs, or eggs becoming chilled or over-heated.
- ✓ Condensation will form when cold eggs are placed in a warmer environment. This is often overlooked when eggs are being transported from the farm to the hatchery and can be prevented by using environmentally controlled egg transport.
- ✓ Eggs should be gradually cooled from laying to the hatchery egg storage room, which should be the coolest point for the egg. Temperature fluctuations during egg storage time will cause a higher early embryonic mortality and poorer quality chicks.
- ✓ Slow circulation fans must be placed so that the room temperature is very uniform which will promote uniform temperatures of the hatching eggs.

The ideal temperature curve for eggs after laying through storage.
 The reduction of temperature occurs gradually until the storage temperature is reached with no elevation of temperature until preheating.

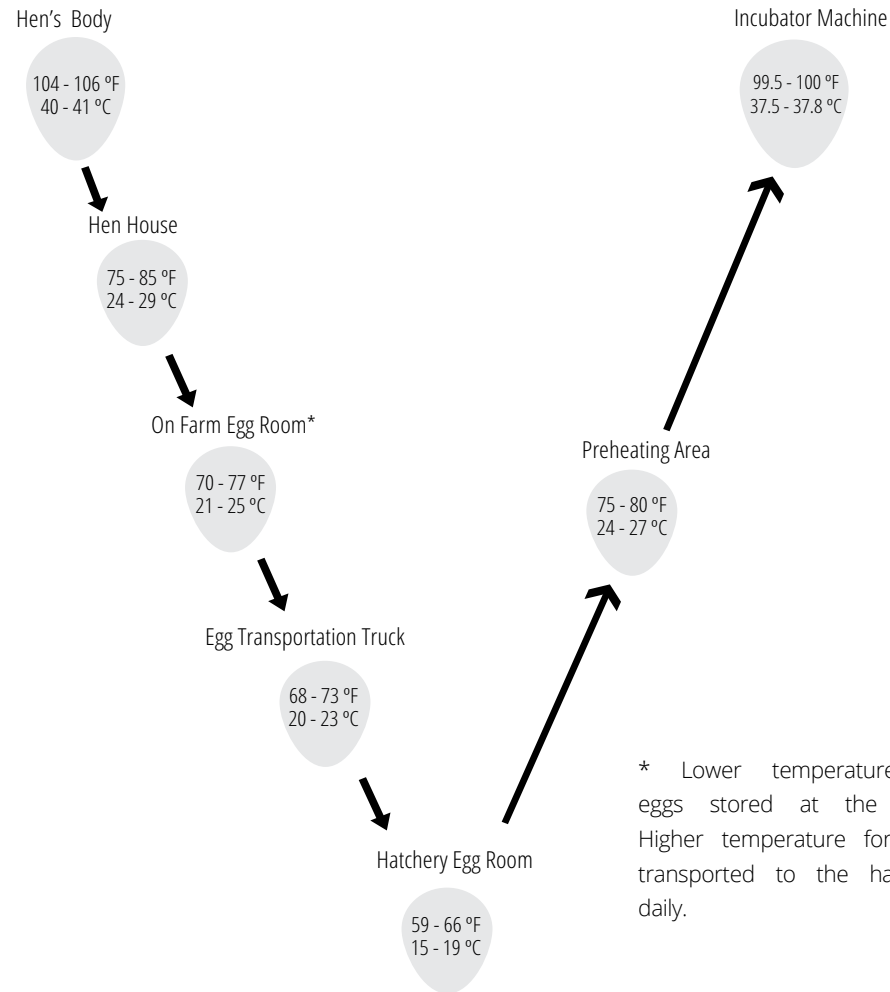

↓ *Cobb Hatchery Management Guide is available online under **Resources > Guides***

Causes and possible solutions for floor eggs

Causes	Possible Solutions
Too much litter placed in the floor area	Measure the litter depth and reduce to 2 to 3 cm (3/4 to 1 in).
Hens not trained in rearing to be mobile and active	Walk through the flock frequently to encourage flock activity, adjust rearing facilities with training slats and / or manage the chain feeder height correctly.
Wrong house configuration, equipment and slat-nesting system	Check house configuration including slats, feeder and water placements. See section 4.6 for details.
Hens not fully conditioned before photo stimulation may show abnormal nesting behaviors	This can include hens dropping eggs from a standing or even walking position, which can cause cracked, slat and floor eggs and stimulates the males and females to eat the eggs.
Floor eggs collected too infrequently	Collect floor eggs on a very regular basis for the first 3 to 4 weeks of production and never leave floor eggs for the next day to collect.
Chain feeder lines in production are too low; females cannot easily pass under to access drinkers and nests	Raise feeder lines. The lip of the feeder line should be even with the bird's upper crop.
Excessive male activity causing slatting of females	Adjust male to female ratio, control male bodyweight and/or sexual maturity in younger flocks.
Using flooring other than concrete may result in females digging in dirt floor to create nests	Most companies are moving towards using concrete floors for biosecurity reasons as well as regulatory issues within exports. Ensure that the concrete is poured correctly and at least 6 to 7 cm (2 3/8 to 2 3/4 in) thick. Under the concrete slab, place a plastic cover to prevent wet concrete by capillary action of water.
Opening nests too early / before production starts	Open the nest when the first egg is laid. Opening the nest too early will cause hens to lose interest, use nests as a resting place, and heavy soiling in the nest (which will require time and labor to clean).
Incorrect light distribution over floor area	Aim for >75 % uniformity of lighting around non-nesting areas of the house and litter area particularly. Shadowed areas outside of the nest will encourage floor eggs.
Incorrect feeding time	Distribute feed a few minutes before the lights come on (the time it takes for the feed chain to cycle) to a maximum of 30 minutes after lights are on (switch lights off for several minutes for good feed distribution). If feed is distributed 2 to 3 hours after lights are on, hens will leave nests increasing the probability of floor eggs.
Uneven bird distribution over house	If birds congregate in one area of the house (typically around personnel doors), the nests in that area will become overcrowded. Using partitions in the house can improve flock distribution and prevent overcrowding of nests.
Use of pan or open auger system for females in production	These systems are not recommended. However, if used, raise the feeding system after feed is consumed. Leaving the system down will create shadowed areas (below the pans on slats and litter) where hens tend to lay more eggs.
Incorrect nest design and dirty nests	Nests that are too small, have too much bedding, have worn out nest pads, or are dirty will not be attractive to hens.
Running the belt system in the first week of production	Do not run the belt too often or on an irregular schedule as this can scare hens out of nests.
Feed cleanup times are too long	Evaluate the feeding program, feed consistency and presentation, ventilation and water system.
Incorrect drinker space / nipple drinkers	Use sufficient drinker space so hens will not have to wait to drink and drop eggs on slats while waiting.
Overweight hens having issues accessing the nest	Use a step, basket or ramp for females to access the nests. Evaluate feeding program and adjust if needed.
Red mite infestations can irritate the hens so much that they will not enter the nests	Treat the nests with antiparasitics, improve the clean-out protocol and apply a mite control program.
Incorrect ventilation creating drafts in nests or excessive heat	Check ventilation systems. Ensure there are no drafts into the nests. Check temperature settings.

13

Flock Depletion

The life of a parent stock flock is normally between 60 and 65 weeks of age and depends on various factors including market conditions, flock production, fertility and hatch percentage. The depletion time is also based on economics which will consider the cost and potential profit of the flock.

When brooding and rearing are separated from the production house, the time that the flock stays in the rearing or production unit is fixed. This rotation program will require that the houses are cleaned and disinfected before a new flock is placed. The rotation program provides the lowest investment cost in housing, allows staff to be dedicated to either rearing or production and one production unit can be supplied with flocks originating from two rearing units.

When a single house is used for brooding, rearing, and laying, the timing of depletion is more flexible than with a rotation program. With the single house system, depletion can be delayed if the flock is still producing very well and/or there is a high demand for hatching eggs. Additionally, with this system the biosecurity risk is reduced since the flock is not moved which also eliminates the stress caused by a move.

Once it is determined that the flocks must be depleted the birds will normally be brought to a processing plant. Feed is withdrawn on the processing day but water is available until the catching crew arrives. Under normal conditions, best practices show that a feed withdrawal period of 8 to 12 hours can empty the intestinal tract (crop through the vent) while the intestines retain strength and integrity. Maintaining intestinal integrity is critically important

to minimize tears and breaks during processing and to minimize the risk of contamination during the evisceration process. If 12 hours of fasting are exceeded, intestines begin to weaken and can easily break, posing a higher risk of contamination of carcasses with intestinal contents.

Feeders, drinkers and any removable equipment should be raised or removed before catching begins. Typically, slats and nest boxes remain during the catching process. To prevent piling and crowding, barriers are used to congregate birds into smaller groups within the scratch area. There are two methods for catching, by the legs or back. Both methods are described in detail, along with other detailed information on catching, transportation and processing, in our Cobb Processing Guide available at: <https://www.cobb-vantress.com/resource/management-guides>.



*The Cobb Processing Management Guide is available online under **Resources > Guides** at [Cobb-Vantress.com](https://www.cobb-vantress.com)*



13.1 Breeder Farm Cleaning and Disinfection

The most important factor in keeping poultry healthy is maintaining good hygiene. Healthy parent flocks and hygienic hatchery conditions contribute greatly to starting with disease-free chicks. Therefore, farm sanitation is critically important to establishing and maintaining a healthy breeder flock throughout the production period.

The house should remain empty for a minimum of 28 days from last disinfection to first placement of birds in the house. Conduct frequent biosecurity audits at each farm. It is important to audit the entire facility to ensure compliance with company expectations for cleaning, disinfection and biosecurity.

There are several steps to the cleaning and disinfection process. First, dry cleaning is performed which involves the physical removal of debris including dirt, dust and litter using equipment such as tractors, blowers and brooms. Wet cleaning is then done to reduce or eliminate debris adhered to surfaces and in difficult to reach places facilitated by water and detergent. Finally, when all surfaces are free of debris and clean, the poultry house is disinfected to reduce and eliminate microorganisms that could be health hazards for the next breeders placed.

House preparation and pre-cleaning

1. Ensure that the house is completely empty before cleaning.
2. Insects (flies, mites, ticks, beetles and cockroaches) carry and spread diseases. An effective insect eradication and control program is most effective once the house is empty but still warm. Spray an approved insecticide both inside and outside the building (including a 6 m (20 ft) wide area around the house). The outside application is important because insects will look for places to hide and hibernate as the building cools making eradication more difficult. The building should be closed for three to four days after insecticide treatment. Heavy insect infestations may require an additional insecticide application after the disinfection process is completed.
3. After house depopulation, use bait stations and rodenticides that cause death after a single dose. All feed should be removed from feeders to attract rodents to the bait stations. Bait stations should be placed inside and outside the poultry houses. Maintain the rodent control program during the cleaning process.
4. Collect and remove litter from the flock in sealed trucks. Bury or burn the litter if the previous flock has experienced a disease or insect outbreak.
5. Perform maintenance and repair of surfaces including floor cracks, door frames, damaged panels, slats and equipment.
6. Bag all unused feed from the feeder lines/tracks, feed bins and cross augers. Remove all bagged feed from site.
7. Feed silos/bins should be thoroughly cleaned and fumigated. Ensure feed bins are completely dry before refilling to prevent caking and mold growth.
8. Dry clean any equipment that cannot be washed directly and cover it completely to protect it from the washing process.
9. Clean the control room electrical panels using power air blowers or vacuum cleaner.



Animal Welfare Tips

All equipment (slats, feeders, drinkers, nests, etc.) should be thoroughly evaluated during the pre-cleaning process from a welfare and maintenance perspective. Any defective or broken equipment should be repaired or replaced so that it can be disinfected in later stages of house cleaning. The goal of this proactive maintenance process is to limit injury and entrapment hazards for the next flock of breeders placed in the house.

Dry cleaning

1. All cleaning should begin with the uppermost surfaces and proceed downwards to minimize possible re-contamination of previously cleaned areas.
2. Remove and discard all paper products associated with the previous flock. These items cannot be disinfected effectively. Dismantle all removable equipment, slats and fittings, remove them from the building and collect them in a specific area outside the poultry house for cleaning. In some locations, part of the equipment can be cleaned inside the house during the winter after litter and droppings have been removed. Movable community nests parts are normally cleaned and disinfected inside the house.
3. Dry cleaning (i.e. brushing, scraping, vacuum cleaners, air blowers etc.) should be performed inside and outside the poultry house, farm storage, and egg rooms. While dry cleaning, pay special attention to the fans and air inlets, light system, beams (especially in corners) heating system and electrical equipment which cannot be removed (e.g. motors, switches). These difficult areas should be dry cleaned by blowing with compressed air.
4. Egg collection equipment should be opened and egg belts removed. All egg debris, dust and dirt should be swept away.

Wet cleaning

1. Open any drainage covers and water runoff pathways and wash down all interior surfaces of the house and fixed equipment with a general detergent applied by a pressure washer.
2. All removable equipment and fittings should be taken out of the building and soaked in clean water in a tank or pit. After soaking they should be cleaned with a pressure washer.
3. All cleaning should begin with the uppermost surfaces and proceed downwards to minimize possible re-contamination of previously cleaned areas. The house should be washed in the direction of the best drainage or along the slope of the floor.
4. Apply the foam or gel detergent and allow the recommended soak time so that the product has adequate time to work. Always wash from the ceiling to the floor – if ceiling fans are present, they should be washed first.
5. Prevent standing water around the poultry house - each farm should have adequate drainage and dirty water collection tanks that meet local environmental regulations.
6. All outside concrete areas and ends of the house should be washed completely.
7. In curtain sided houses, special attention should be given to cleaning both the inside and outside of the curtains and preventing dirt collecting in the curtain pocket. Light traps at the inlet and fan end will need special attention to remove all organic material between the ribs or fins.
8. Use the pressure-washer on the house exterior to clean the fan shafts and air inlets. It is advisable to wash off the dust that accumulates on the roof and in the gutters. Be aware that high pressure water can potentially damage blades, aluminum shutters, and other soft materials. Use high pressure water pressure cautiously. Wooden community nests cannot be high pressure washed and can be damaged with excessive water pressure.
9. Water storage or header tanks must be cleaned with a detergent. Drain the drinking system and header tank completely before adding cleaning solution.
10. Drinking systems should be drained and then primed with an approved hydrogen peroxide solution to dissolve any biofilm, followed by a high pressure flush. Apply an acid base solution to dissolve scale deposits followed again by a high pressure flush. During both procedures all nipples should be activated to prevent debris accumulation. Finally, flush the whole system with a sanitizing solution. Make sure that any trace of disinfectant is removed as it can impair the use of live vaccines.

Sanitizing and disinfecting

1. Perform any equipment or facility repairs and replace or plug any drainage openings.
2. Visually inspect every part of the farm facilities for cleanliness. This inspection should be done in good light and after the house and equipment have dried.
3. When the surfaces are dry, apply an effective broad-spectrum disinfectant through a pressure washer with a fan jet nozzle. Disinfect by moving from the top to the sides and then the bottom of the house and from the back to the front of the house. Thoroughly soak all the interior surfaces and equipment. Fan boxes, inlets, support beams and posts require special attention.
4. Disinfect the areas of the roof surrounding the fan shafts and the gutters.
5. Spray a 6 m (20 ft) wide band around the perimeter of the house with the disinfectant solution.
6. Include the egg handling and storage rooms, feed storage area, changing rooms and showers during the cleaning and disinfection process.
7. For removable equipment and fittings, once all organic material has been removed, they should be soaked in a disinfectant solution per the dilution rate as recommended by the manufacturer.
8. Drying down after disinfection is advantageous. Heat and ventilation will speed this process.



9. Staff areas, canteens, changing areas and offices must be thoroughly cleaned and disinfected.
10. All footwear and clothing must be washed and disinfected.
11. After disinfection, biosecurity controls at house entrances must be reinstated.
12. Adequate downtime between flocks always increases the efficacy of the hygiene program.



Animal Welfare Tips

After the house has been disinfected, all equipment should be set up (ex: slats) and tested to ensure functionality (ex: controller, fans, light, feeding system, etc.). The goal of this test is to ensure that the infrastructure is configured correctly for bird safety (ex: slats and pen dividers are installed correctly to prevent bird entrapment) and to ensure all equipment will work correctly before the new flock of breeders is placed.

13.2 Disinfectants

Most disinfectants are dissolved in water and contact lasts until the applied solution is dry. Foaming disinfectants can increase the contact time as it takes longer to dry, and consequently the antimicrobial activity of the disinfectant is extended. Cleaning with detergents can reduce the microbial load by 80%. Disinfectants can reduce the microbial load by an additional 20%. However, disinfectants will not be effective on dirty surfaces. All surfaces must be clean prior to applying disinfectants.

Most disinfectants work best at temperatures above 20 °C (68 °F), but follow the manufacturer's recommendation for the dilution rate and the diluent water temperature. Hot disinfectant solutions penetrate and disinfect better than cold solutions. This is especially important with porous surfaces.

No single disinfectant works for all purposes. The product chosen should have proven effectiveness in tests against the relevant organisms in the region. Disinfectants can be inactivated by organic matter and inactivated by pH extremes, soap residues and minerals in the water. Care should be taken to ensure that the disinfectant is not corrosive to the target surface.

Chemical safety

Personnel must be aware of any chemical hazards disinfectants may pose. Personnel must be trained correctly to use any equipment involved in chemical applications. Training should deliver information so that workers are aware of the properties of every chemical used and they understand terminology of chemicals and chemical safety. Control measures, including the use of personal protective equipment (PPE), are mandatory when working with chemicals to protect against exposure. Safety Data Sheets (SDS's), and compatibility charts should be available for finding hazard information about disinfectants and other chemicals. All chemical containers should have the original manufacturer's label and chemicals should never be poured into non-labelled containers for storage. All chemicals (toxic and non-toxic) should be treated as though they were toxic.

The efficacy of disinfection depends on:

- ✓ quality of cleaning
- ✓ hardness of water
- ✓ quality and suitability of disinfectant
- ✓ correct dilution and application

Disinfectants are grouped based on their chemical structure:

- ✓ halogens (iodophors and chlorines)
- ✓ alcohols
- ✓ oxidizing agents (hydrogen-peroxide)
- ✓ phenols
- ✓ aldehydes (formalin)
- ✓ quaternary ammonium compound

Chemical storage

Segregate chemicals in storage according to hazard class to prevent reactions. Ideally, store chemicals in separate cabinets. Flammable chemicals such as alcohols should be stored in a flammable storage cabinet. Chemicals should be stored in appropriate containers to prevent leakage and inactivation. Store chemicals under the appropriate environmental conditions including temperature and humidity ranges. Check the manufacturers' label for these storage requirements.

Formaldehyde

Formaldehyde can be a very effective disinfectant. However, formaldehyde is carcinogenic and not all countries and regions permit the use of this chemical. Check with your local regulations before you consider using formaldehyde as a disinfectant. There are also several very effective disinfectants that are available (see table on proceeding page).

Characteristics of Selected Disinfectants

Category	Alcohols	Alkalis	Aldehydes	Halogens: Chlorine	Halogens: Iodine	Peroxygen Compounds	Phenols	Quaternary Ammonium Compounds
Active ingredients	ethanol, isopropanol	calcium hydroxide, sodium carbonate, calcium oxide	formaldehyde, glutaraldehyde, ortho-phthalaldehyde	sodium hypochlorite (bleach) calcium hypochlorite, chlorine dioxide	povidone-iodine	hydrogen peroxide/accelerated HP, peracetic acid, potassium peroxy-monosulfate	ortho-phenylphenol, orthobenzylpara-chlorophenol	benzalkonium chloride, alkyldimethyl ammonium chloride
Trade Names*			Synergize®	Clorox®, Wysiwash®		Rescue®, Oxy-Sept 333®, Virkon-S®, Ecocid®, Virkon H20®	One-Stroke Environ®, Pheno-Tek II®, Tek-Trol®, Lysol®	Roccal-D, DiQuat, D-256
Mechanisms	Precipitates proteins; denatures lipids	Alters pH through hydroxyl ions; fat saponification	Denatures proteins; alkylates nucleic acids	Denatures proteins	Denatures proteins	Denatures proteins and lipids	Denatures proteins & disrupts cell walls	Denatures protein; binds phospholipids of cell membrane
Characteristics	Fast acting Rapid evaporation Leaves no residue Can swell or harden rubber and plastics	Slow acting Affected by pH Best at high temps Corrosive to metals Severe skin burns; mucous membrane irritation Environmental hazard	Slow acting Affected by pH and temperature Irritation of skin/ mucous membrane Only use in well ventilated areas pungent odor Noncorrosive	Fast acting Affected by pH Frequent application Inactivated by UV radiation Corrodes metals, rubber, fabrics, Mucous membrane irritation	Stable in storage Affected by pH Requires frequent application Corrosive Stains clothes and treated surfaces	Fast acting May damage some metals (e.g., lead, copper, brass, zinc) Powdered form may cause mucous membrane irritation. Low toxicity at lower concentrations. Environmentally friendly	Can leave residual film on surfaces Can damage rubber, plastic; non-corrosive Stable in storage Irritation to skin and eyes	Stable in storage Best at neutral or alkaline pH Effective at high temps High concentrations corrosive to metals Irritation to skin, eyes, and respiratory tract
Precautions	Flammable	Very caustic	Carcinogenic	Toxic gas released if mixed with strong acid or ammonia			May be toxic to animals, especially cats and pigs	
Bactericidal	+	+	+	+	+	+	+	+
Virucidal	<u>a</u>	+	<u>±</u>	+	+	+	+	+ enveloped
Fungicidal	+	+	+	+	+	<u>±</u>	+	+
Sporicidal	-	+	+	+	+/-	+	-	+
Factors Affecting Effectiveness	Inactivated by organic matter	Variable	Inactivated by organic matter, hard water, soaps and detergents	Rapidly inactivated by organic matter	Rapidly inactivated by organic matter	Effective in the presence of organic matter, hard water, soaps and detergents	Effective in the presence of organic matter, hard water, soaps and detergents	Inactivated by organic matter, hard water, soaps and detergents

+ = effective; ± = variable or limited activity; - = not effective

a - slow acting against non-enveloped viruses (e.g., norovirus)

*Disclaimer: The use of trade names serves only as examples and does not in any way signify endorsement of a particular product.

This table provides general information for each disinfectant chemical classes. Antimicrobial activity may vary with formulation and concentration. Always read and follow the product label for proper preparation and application directions.

Table sourced from Iowa State University, Center for Food Security and Public Health available at: <http://www.cfsph.iastate.edu/Disinfection/Assets/CharacteristicsSelectedDisinfectants.pdf>

13.3 Sanitation Program Monitoring

To monitor the effectiveness of the sanitation program, a visual inspection and sampling for microbes is suggested. The effectiveness of the sanitation program can be measured using quantitative and qualitative laboratory tests. Sterilization of the facilities is not realistic but microbiological testing can confirm that all undesirable organisms including *Salmonella* have been eliminated. A documented audit including both visual and microbiological testing and attention to the performance of subsequent flocks can support the effectiveness of the sanitation program. Some key points for a sanitation monitoring program are listed below:

- ✓ A minimum of ten swabs per house should be taken for laboratory analysis.
- ✓ It is impossible to sterilize a house, but it is possible to reduce the number of microorganisms. The bacterial counts or total viable count (TVC), are used as an indicator for the effectiveness of the house cleaning procedures. The maximum total viable count in colony forming units per cm² of floor area should not exceed 1,000 (TVC) and maximum 100 (TVC) for all other surfaces. No *Salmonella* should be isolated after cleaning.
- ✓ Maintain a rigorous vermin control policy including an anti-rodent barrier against the outside house or unit perimeter.
- ✓ Always keep the doors shut to prevent re-introduction of vermin and other contaminants. Seal any gaps or cracks in doors and walls. Openings around doors and walls can give rodents and insects access into the houses, compromising the biosecurity of the flock.



Validate the cleaning and disinfecting of houses by sampling and culturing for bacteria loads and target pathogens including *Salmonella*.

Ventilation Management

To achieve optimal flock performance the ventilation system must provide optimal conditions in both cold and hot conditions. In cold weather and during brooding, the system must control moisture and air quality while also ensuring uniform and stable temperatures. During hot weather the ventilation system must provide sufficient cooling capacity to keep the birds as comfortable as possible. However, the house environment is a dynamic environment with fluctuating temperatures, air quality and humidity levels which requires constant monitoring and adjustments to ventilation.

Managing poultry house humidity and litter moisture are two of the greatest challenges a producer may face. High house humidity conditions during hot weather produce two challenges; it reduces the birds thermoregulation ability through evaporative cooling and makes the management of litter moisture conditions challenging.

During cold weather the challenge is to condition the incoming cold air before it circulates to bird level. Mixing the incoming cold air with the heat trapped at ceiling level due to natural stratification along with circulation fans are the two most important concepts the producer needs to master for the successful management of litter moisture.



Animal Welfare Tips

Airspeed and ventilation are very important tools to help maintain an ideal environment and a comfortable temperature for the flock. From a welfare viewpoint, always observe flock distribution and bird behavior when transitioning to different stages of ventilation. The birds will 'indicate' if they are comfortable (or not). Ideally, birds should be uniformly distributed in the house and should remain active. If birds are migrating to one area, or still showing signs of heat stress, evaluate the operation of the ventilation system (incoming air speed, airspeed in the center of the house, inlet pressure, fan condition, etc.) and then fix any problems.

14.1 Circulation Fan Installation Options

The primary function of a circulation fan system is to disperse the natural heat stratification in the house. It is not unusual to see up to 5 °C (25 °F) difference between the ceiling and floor level. These systems are designed to mix the air from the floor to ceiling by producing air movement at floor level of between 0.25 to 0.76 m/s (50 to 150 fpm), removing moisture from the litter. There are many different designs and setups for circulation fans.

Circulation fan requirements:

- ✓ Capacity: approximately 10 to 20 % house volume.
- ✓ Typical circulation fan size and capacity: 450 mm (18 in) fans with capacity of 70 m³/min (2500 cfm).
- ✓ In high ceilings and new tunnel ventilated houses, larger 600 mm (24 in) circulation fans with a capacity of 140 m³/min (5000 cfm) are being used.

Example calculation of how many fans are needed:

12 m (40 ft) wide house; 150 m (500 ft) length; 3 m (9.5 ft) average height

12 m (40 ft) x 150 m (500 ft) x 3 m (9.5 ft) = 5472 m³ (190,000 ft³)

5472 m³ (190,000 ft³) x 10 % = 547 m³/min (19,000 cfm) stir fan capacity

547 m³/min (19,000 cfm) ÷ 70 m³/min (2,500 cfm) = 7.6 or 8 fans

The large red arrows indicate high velocity movement at ceiling level, while the smaller yellow arrows indicate the low velocity return created at floor level.

Increasing circulation fan capacity will increase the “return” air movement at floor level. As long as the return is warm, moving warm air does not constitute as a draft!

The more circulation capacity, the dryer the litter.

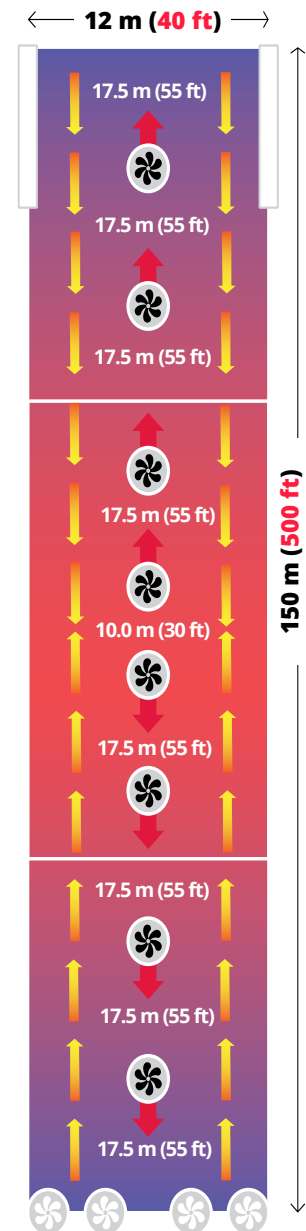

Animal Welfare Tips

Circulation fans help with air mixing in the house and are important tools to help maintain dry litter throughout the house. Dry litter is important for maintaining good footpad health, providing pullets and breeders with a comfortable environment and promoting positive bird behavior.

14.2 Minimum Ventilation

Minimum ventilation systems are designed to manage moisture and air quality using fans on a cycle timer. This system is independent of the temperature control and the minimum air exchange is linked to the amount of moisture added to the house by the birds, as well as the drinking, heating, and ventilation systems. Under most conditions, maintaining good moisture control should ensure carbon dioxide and ammonia levels are kept below 3000 and 10 ppm, respectively.

High levels ammonia are always linked to high house humidity and litter moisture. High levels of ammonia can increase the birds susceptibility to disease and potentially creating a welfare issue. Additionally, birds raised in wet litter conditions can have a rapid decline in foot health and may lead to pododermatitis.

There are 3 key functions of minimum ventilation:

1. Moisture and humidity control
2. Provide oxygen to meet the bird's metabolic demand
3. Maintenance of good litter conditions

*The maximum level of CO₂ allowed at any time in the chicken house is 3,000 ppm. If the house environment exceeds 3,000 ppm of CO₂ or less than 19.6 % O₂ then the ventilation rate must be increased.

Air quality guidelines	
Oxygen %	> 19.6 %
Ammonia	< 10 ppm
Respirable Dust	< 3.4 mg/m ³
Relative Humidity	45 to 65 %
Carbon Monoxide	< 10 ppm
Carbon Dioxide (CO ₂)	< 0.3 % / 3,000 ppm
Air exchange (with minimal air movement at chick level)	<0.30 m/s (60 fpm)



Animal Welfare Tips

With increased CO₂ levels (> 3,000 ppm), bird behavior and activity will be reduced. If not corrected, this reduced activity level can negatively impact bird growth and feed consumption. Always evaluate flock behavior and adjust the ventilation system to keep the birds comfortable.

5-minute timer cycle to control minimum ventilation

- ✓ The timer fans should provide an air exchange capability of approximately 12.5 % or a capacity of 0.3 to 0.61 m³/min per m² of floor area (1 to 2 cfm per 1 ft² of floor area).
- ✓ Always match fan capacity as close to requirement as possible.
- ✓ At placement, fans should be cycled for approximately 30 to 60 seconds to ensure adequate mixing of cold incoming and warm internal air (see table right).
- ✓ A 5-minute (300-second) on/off cycle is preferred for minimum ventilation. The cycle should never exceed 10 minutes.
- ✓ Any time the air quality begins to deteriorate, the ON time must be increased - but the total cycle time always remains constant.
- ✓ Humidity should be maintained below 60 to 65 % where possible.
- ✓ Increases in ON times should be made in small increments – 10 to 15 seconds and monitored for 24 hours.
- ✓ Correct operation of the perimeter inlets is vital in achieving good air distribution and moisture control.
- ✓ The inlet capacity should match the fan capacity at the required working pressure based on the width of the house.

Minimum ventilation timer settings (5 min (300 sec) timer)		
Day	On (seconds)	Off (seconds)
1	60 (20 %)	240
3	60	240
5	75	225
8	90	210
11	105	195
14	120	180
18	135	165
22	150	150
25	165	135
30	180 (60 %)	120



Animal Welfare Tips

If the flock is inactive, appears uncomfortable, or noisy due to thermal stress, consider increasing the time “on” for the cycle timer so that air exchanges are increased. Increasing the fresh air and improving the air quality in the bird space can result in more active, uniformly distributed, and comfortable birds.

14.3 Fans Required for Minimum Ventilation

The minimum ventilation system must have sufficient capacity to operate for the full life of the flock. The following is an example calculation of the number of fans required. **The minimum ventilation calculations are only guidelines.** Daily adjustments should be made based on air quality and humidity. The range and capacity of fans to be used for cycle ventilation will increase over time until all installed minimum ventilation fans are used.

Calculations for the minimum number of fans required for ventilation in a typical tunnel house

Sample fans

- ✓ Fans capacities used in the examples are rated at 25 pa (0.1 in wc)
- ✓ Exhaust or side wall fans: 900 mm (36 in), working capacity of 340 m³/min (12,000 cfm).
- ✓ Air exchange range: 0.3 to 0.60 m³/min per m² of floor area (1 to 2 cfm per ft² of floor area).

Notes: Ideally these fans should be fixed volume and not variable speed. The 2 cfm per ft² of floor area fan capacity is only needed in cold climates.

Sample house dimensions

House dimensions: 150 m long, 14 m wide and 2.88 m average height
 House dimensions: 500 ft long, 46 ft wide and 9.25 ft average height

Average height = 2.5 m + (0.5 x 0.75 m) = 2.88 m
 Average height = 8 ft + (0.5 x 2.5 ft) = 9.25 ft

House floor area: 150 m x 14 m = 2,100 m²
 House floor area: 500 ft x 46 ft = 23,000 ft²

(House floor area X Air exchange rate) ÷ Working capacity = Number of fans required

Number of fans required for air exchange range of 0.3 to 0.6 m³/min per m²
 2,100 m² x 0.3 to 0.6 m³/min per m² of floor area = 630 to 1260 m³/min
 630 to 1260 ÷ 340 m³/min = 1.85 to 3.70 or **2 to 4 fans**

Number of fans required for air exchange range: 1 to 2 cfm/ft²
 23,000 ft² x 1 to 2 cfm per ft² of floor area = 23,000 cfm to 46,000 cfm
 23,000 cfm to 46,000 cfm ÷ 12,000 cfm = 1.91 to 3.83 or **2 to 4 fans**

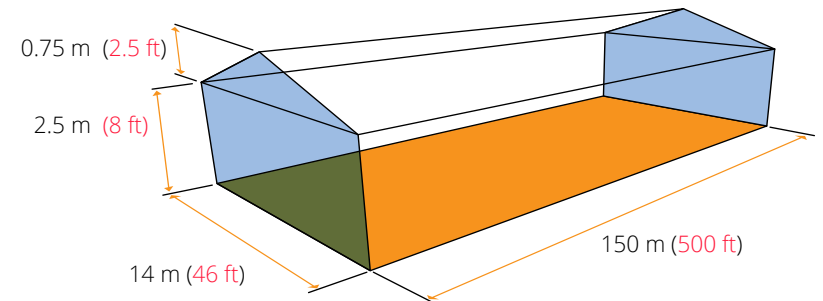

14.4 Negative Pressure - Key Requirement for Minimum Ventilation

The most efficient way to accomplish air distribution for minimum ventilation is by using a negative pressure ventilation system. The pressure drop across the inlets and amount the inlet is opened should be adjusted to ensure that the incoming air jet attaches to the ceiling and reaches the peak of the house where the heat has accumulated.

The table (right) can be used as a reference guide to determine the required inlet pressure drop. The pressure drop selected will depend on the house width, how far the incoming air jet must travel once it enters the house, and the outside temperature. When outside temperatures are below 5 °C (40 °F) the inlet pressure drop and opening size will need to be increased. The ability of the incoming air jet to attach to the ceiling depends on the temperature differentials between outside and inside the house. Always use a smoke test to ensure that the incoming air reaches the center of the house. Smoke tests should only be done when the outside temperatures are significantly colder than inside, and when there is no wind.

In houses with obstructions such as purlins or electrical conduit which can interrupt the incoming air jet, smooth solid ramps of about 3 m (9 ft 10 in) need to be installed in front of the perimeter inlets.

Note: In houses with side wall (perimeter) inlets that are positioned lower on the wall, the pressures and inlet openings need to be increased accordingly to ensure the incoming air jet reaches into the center of the house. This is especially important with low outside temperatures.

Required inlet airspeed and pressure difference							
House width		Pascals (Pa)	Inches of water	Airspeed		Distance air travels	
m	ft			m/s	fpm	m	ft
10	30	20	0.08	5.7	1,112	5.0	16
12	40	25	0.10	6.5	1,280	6.0	20
15	50	31	0.12	7.2	1,417	7.5	25
18	60	37	0.15	7.8	1,535	9.0	30
21	70	43	0.17	8.4	1,654	10.5	35
24	80	49	0.20	9.0	1,772	12.0	40

Guideline: For every 61 cm (2 ft) the incoming air needs to travel, a pressure drop of 2.5 Pa (0.01 in wc) is required. This will need to be significantly increased when outside temperatures drop below 5 °C (40 °F).

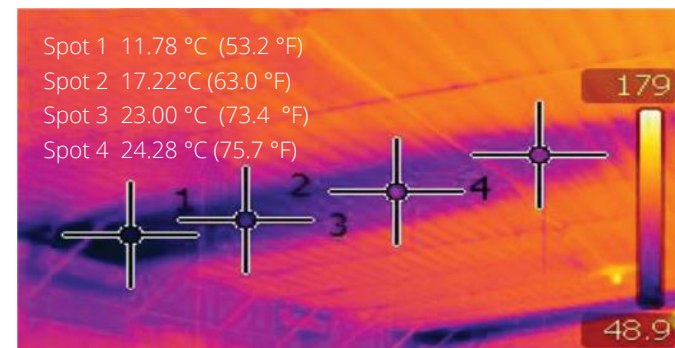

The infrared image shows the correct flow of cold air entering the house via a perimeter inlet. The gradual increase in ceiling temperatures is noted in spots 1 to 4 as the air reaches the center of the house.



Animal Welfare Tips

In addition to daily temperature monitoring, evaluate bird behavior, activity and distribution within the house. If birds are hot or chilled, they will behave differently than birds that are comfortable. For example, if cool air enters via inlets, does not mix at the ceiling and drops directly to the floor, birds will preferentially move away from this cooler area and may huddle or congregate in a more central location in the house.

14.5 Perimeter Inlet Management and Installation

Perimeter inlets are arguably the most important part of the house ventilation system. Positioning and design of the inlets will significantly impact the direction of the incoming cold air. During cool seasons, fresh air (cooler and heavier) that enters the house mixes with warm, dry air before reaching the level of the birds. While mixing, the temperature of the incoming air increases and humidity decreases. The perimeter inlets are one tool that can initially manage the incoming air. With these, the airflow can be directed in a way that allows the air to gain heat and decrease humidity as it flows into the center of the house. For every 11 °C or 20 °F increase in temperature the relative humidity will be halved.

The most common consequence of poorly managed inlets is the humidification and compaction of the litter, primarily along the side walls. A well-designed inlet should close and seal completely when the fans are off. When open, the air should only enter over the top of the inlet and not from the sides or the base of the inlet. Inlets that leak air through the sides and base will direct cold air to the floor, resulting in chilled birds and condensation.

Inlet openings should be pressure controlled to maintain a constant airflow at different fan capacities. When cables are being used to operate the inlets, special attention needs to be given to the nylon cords which are closing the inlets. Cables can stretch and are prone to cause uneven openings. Inlets that do not close completely will cause heat and energy losses, especially under windy conditions. An 8 mm steel rod is the preferred material to be used when installing the inlets.

The inlets used for minimum ventilation need to open enough to achieve the required static pressure and air jet. Depending on the inlet design, a minimum opening of 2.5 cm to 5 cm (1 to 2 in) is required to ensure cold incoming air jets attach to the ceiling and detach near the center. Always smoke test the house in cold weather or attach a series of ribbon tapes to the ceiling in front of the inlet to the center of the house. Place these ribbons at an inlet close to the control room for easy observation.

Ideal air flow and air mixing

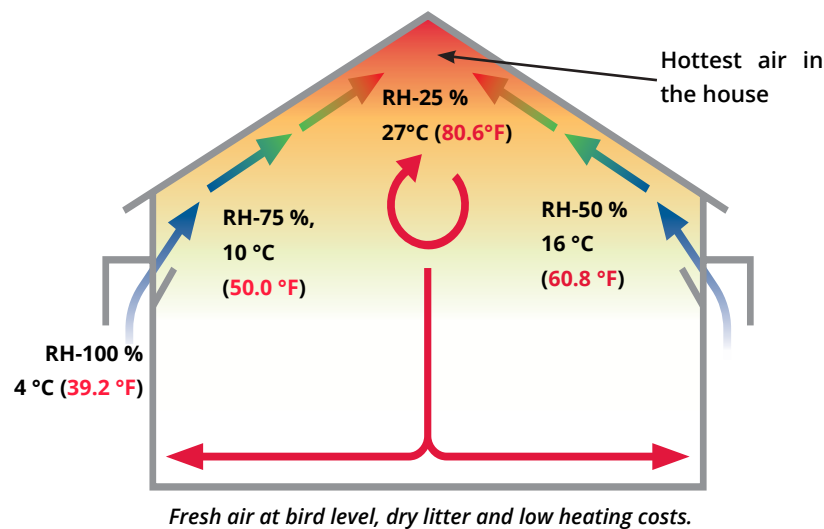

Poor air flow and mixing

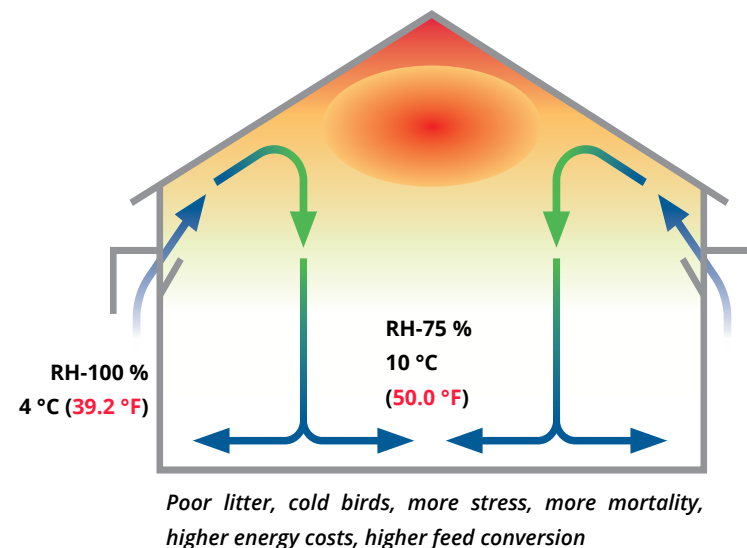

14.6 Simple Negative Pressure Test

To effectively generate a negative pressure system in a controlled environment rearing or production house, the house needs to be as airtight as possible. Typically, leaks are located along the roof ridge, close to the fans, around doors and along stem walls. In curtain sided rearing and production houses, the curtains are usually the largest source of leaks.

Test the effectiveness of how well the house is sealed by closing all the inlets, then measure the pressure drop across any inlet or door. Turn on the equivalent of 0.30 m³/min (18 m³/hr per m² of floor area) or (1 cfm per ft² of floor area) of fan capacity per the floor area. A pressure in excess of 37.5 Pa (0.15 in wc) should be recorded across the opening. Pressure < 25 Pa (0.10 in wc), indicates the house is poorly sealed.

14.7 Transition Ventilation

Transition ventilation begins to operate when the house thermostat overrides the cycle timer to allow continuous running of the cycle fans and the staging of the remaining transition fans to control temperature. Transition ventilation is the temperature control stage between the minimum ventilation stage and tunnel ventilation. The key function of transition ventilation is to increase house air exchange and manage temperature without creating high airspeeds or velocity at bird level. The maximum airspeeds, generated in full transition mode, can range from 25 to 50 % of full tunnel ventilation capacity in modern tunnel ventilated houses. It is a vital stage of ventilation in tunnel ventilated houses to ensure bird comfort and early feed intake, especially in rearing. Flock uniformity always starts in the 1st week and is driven by early feed intake and temperature management.

Fan capacity requirement for full transition

In typical pullet and production tunnel houses, the transitional ventilation system typically uses 30 to 50 % of the total tunnel ventilation capacity. In colder climates, having more transition capacity is beneficial. The capacity can also be expressed in terms of floor area: 1.2 to 1.8 m³/min per m² of floor area (4 to 5 cfm per ft² of floor area) or air exchange rates of 2 to 3-minutes when in full transition.

- ✓ These fans use perimeter wall inlets that are evenly distributed lengthwise down the house. The inlets are most efficient when controlled by negative pressure. This system gives excellent temperature control, reduces the risk of chilling the birds, and is a valuable part of any ventilation system.
- ✓ During the final stage of transition ventilation (full transition), the inlets are in their fully opened position and the tunnel inlet will open to provide additional incoming air to match the fan requirement and balance the static pressure.

How many inlets for full transition?

- ✓ Depends on - capacity of a single inlet at a specific static pressure.
- ✓ Depends on - the air exchange requirement in full transition mode.
- ✓ In cold climates, pullet and breeder production houses that do not have a tunnel ventilation system will use perimeter wall inlets for all levels of ventilation. These houses should have a maximum air exchange capacity of less than 1 minute to cope with hot conditions.
- ✓ During the final stage of transition the tunnel inlet opens to balance static pressure.
- ✓ Tunnel ventilation can be delayed by operating more fans through both the perimeter wall and tunnel inlets. These further stages, sometimes referred to as tunnel assist mode, allow significant increases in air exchange without dramatic increases in airspeeds at floor level.
- ✓ For the house to transition to tunnel ventilation, the outside temperature needs to be warm – above 25 °C (77 °F).

Calculating transition ventilation inlet capacity

Sample fans

Fan capacities used in the examples are rated at 25 Pa (0.1 in wc)

900 mm (36 in), working capacity of 340 m³/min (12,000 cfm)

1,270 mm (50 in), working capacity of 680 m³/min (24,000 cfm)

Fan requirement based on house floor area: 1.2 to 1.8 m³/min/m² (4 to 5 cfm/ft²)

Sample house dimensions

House dimensions: 150 m long, 14 m wide and 2.88 m average height

House dimensions: 500 ft long, 46 ft wide and 9.25 ft average height

Average height = 2.5 m + (0.5 x 0.75 m) = 2.88 m

Average height = 8 ft + (0.5 x 2.5 ft) = 9.25 ft

House floor area: 150 m x 15 m = 2,100 m²

House floor area: 500 ft x 46 ft = 23,000 ft²

Example calculation of how many fans are needed using fan capacity of 680m³/min (24,000 cfm)

Floor area x 1.2 to 1.8 m³/min per m² (4 to 5 cfm per ft²) = number of fans needed

2,100 m² x 1.2 to 1.8 m³/min = 2,520 to 3,780 m³/min = **4 to 5 fans needed**

23,000 ft² x 4 to 5 cfm/ft² = 92,000 to 115,000 cfm = **4 to 5 fans needed**

How many inlets needed for transition ventilation?

Example calculations of how many inlets are needed using an inlet capacity of 34.5 m³/min (1,218 cfm) at 25 Pa

Note: If inlet capacity is unknown use the following assumptions: Standard inlet capacity = 7229 m³/min per m² (750 cfm per ft²) of inlet opening at 25 Pa (0.10 in wc).

Step 1: Total Transition Fan Capacity = Number of fans needed X Fan capacity

5 x 680 m³/min (24,000 cfm) =

3,400 m³/min or 120,000 cfm

Step 2: Number of inlets = Total Transition Fan Capacity ÷ Inlet Capacity

3,400 m³/min (120,000 cfm) ÷ 34.5 m³/min (1,218 cfm) =

108 inlets or 54 inlets per side (common practice to add extra 10 % inlet capacity)



14.8 Tunnel Ventilation

Tunnel ventilation is used in hot weather for cooling - the process of removing metabolic heat from the pullets and breeders. The tunnel ventilation fans are placed at one end of the house with the air intake at the opposite end. The air flow creates a wind-chill effect, which produces the effective temperature experienced by the bird. The effective temperature experienced will depend on airspeed, bird age, relative humidity and numerous other factors and can range from 1 to 8 °C below ambient temperatures. Bird effective temperatures should be maintained below 30°C (86°F).

To ensure maximum bird activity and feed intake, during brooding and the first few weeks of the rearing phases, keep airspeeds within the limits given in the table below, unless air temperatures are well in excess of target temperatures for the specific ages. Tunnel fan capacity or air exchange rate should be sufficient to ensure an absolute maximum temperature pickup or differential (ΔT) of 2.8°C (5 °F) from the front to the end of the house on the hottest day.

Age (days)	Max Airspeed (m/s)	Max Airspeed (fpm)
0 to 5	0 to 0.3	0 to 60
5 to 14	0.3 to 0.5	60 to 100
14 to 21	0.5 to 1.8	100 to 350
pullets	2.0 to 2.5	400 to 500
breeders	2.5 to 3.0	500 to 600

Understanding negative pressure measurements in full tunnel mode

The pressure readings will increase from the front to the extraction end of the house. The pressure reading at the extraction end is an indication of the amount of work the fans must do to move the air down the length of the house. It is a sum of the following pressure drops:

1. Pad pressure
2. Inlet light trap
3. Tunnel inlet curtain or door pressure drop
4. Transition or "squeeze" pressure
5. Pipe pressure, which includes resistance created by objects such as nest boxes and feed hoppers
6. Tunnel fan light trap

Estimated fan operating pressure in dark out pullet house with evaporative cooling

$$\begin{aligned} &\text{Pad pressure} + \text{inlet light trap} + \text{transition} + \text{pipe} + \text{fan light trap} \\ &= 12.5 \text{ Pa} + 8 \text{ Pa} + 7.5 \text{ Pa} + 6 \text{ Pa} + 15 \text{ Pa} = \mathbf{49 \text{ Pa}} \\ &= 0.05 \text{ in wc} + 0.03 \text{ in wc} + 0.03 \text{ in wc} + 0.025 \text{ in wc} + 0.06 \text{ in wc} = \mathbf{0.20 \text{ in wc}} \end{aligned}$$

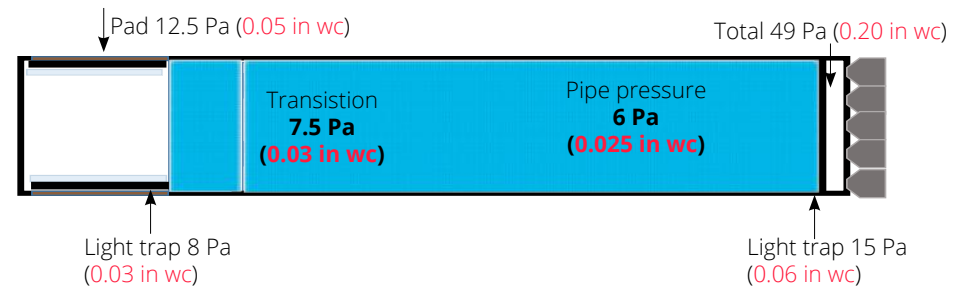

Key points when choosing or comparing tunnel fans

- ✓ The fans most suitable for a tunnel ventilation system are high capacity cone fans with minimum diameters ranging from 1.27 m (50 in) to 1.42 m (6 in) or more
- ✓ All ratings must be at a minimum pressure of 25 Pa (0.10 in wc)
- ✓ Energy efficiency should be 0.0109 m³/s (23 cfm) per Watt
- ✓ Air flow ratio: > 0.75 indicator of how well the fan holds up under high static pressures 12.5 to 50 Pa (0.05 to 0.2 in wc)
- ✓ Fans should be sealed to prevent air leaks when not operational
- ✓ Fans should be purchased on efficiency and build quality – not price



Adjusting tunnel inlet for correct air distribution

The diagrams (below) illustrate the importance of maintaining the correct airspeed and negative pressure drop at the tunnel inlet curtain or door. Very low inlet airspeeds and pressure drops will result in increased “dead spots” (this refers to areas in the house near the walls that have minimal airspeed or in US style production houses on the slats between the nest box and the side wall curtain). The tunnel inlet door or curtain pressure drop must be adjusted to help reduce this phenomenon. If air speeds are not improved temperatures will be higher in these areas and the flock could be subject to heat stress.

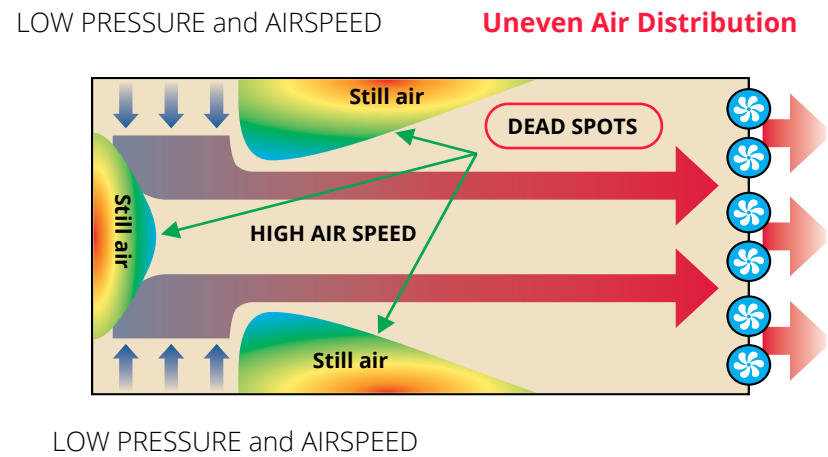
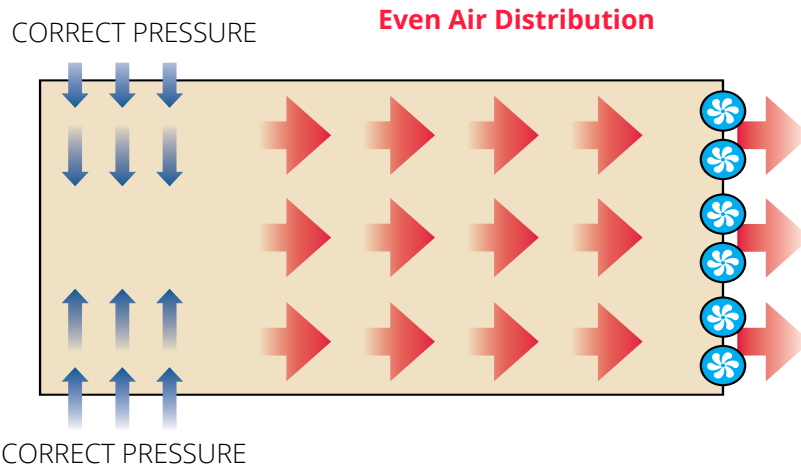

Calculations for tunnel ventilation rates

General tunnel fan requirements for an insulated and sealed tunnel house	
Pullets	Breeders
8 to 9 cfm per ft ²	9 to 10 cfm per ft ²
2.5 to 2.75 m ³ /min per m ² (150 to 165 m ³ /h per m ²)	2.75 to 3.05 m ³ /min per m ² (165 to 183 m ³ /h per m ²)

Sample house dimensions

House dimensions: 150 m long, 14 m wide and 2.88 m average height
 House dimensions: 500 ft long, 46 ft wide and 9.25 ft average height

Cross section: 14 m wide x 2.88 m average height = 40.32 m²
 Cross section: 46 ft wide x 9.25 ft average height = 425.5 ft²

House volume: 150 m long x 14 m wide x 2.88 m average height = 6048 m³
 House volume: 500 ft long x 46 ft wide x 9.25 ft average height = 212,750 ft³

Sample fans

Example for production house: 3 m/s (600 fpm)
 Fans capacities used in the examples are rated at 25 Pa (0.1 in wc).
 1,270 mm (50 in, working capacity of 680 m³/min (24,000 cfm).

Step 1: Fan capacity required to achieve an airspeed of 3.0 m/s (600 fpm) at 25 Pa (0.10 in wc)

Required fan capacity = Cross section x Airspeed
 40.32 m² x 3.0 m/s = **120.96 m³/s or 7,257 m³/min**
 425.5 ft² x 600 fpm = **255,300 cfm**

Number of 1.27 m (50 in) fans required:
 7,257 m³/min ÷ 680 m³/min = 10.67 or **11 fans**
 255,300 cfm ÷ 24,000 cfm = 10.63 or **11 fans**

Step 2: House air exchange should be between 40 and 50 seconds

Air Exchange = House Volume ÷ Total Fan Capacity
 6,048 m³ ÷ (11 x 680 m³/min) = 6,048 m³ ÷ 7,480 m³/min = 0.80 min or **49 seconds**
 212,750 ft³ ÷ (11 x 24,000 cfm) = 212,750 cfm ÷ 264,000 cfm = 0.80 min or **49 seconds**

Step 3: Is the airspeed adequate?

Airspeed = Total Fan Capacity (m³/min) ÷ Cross Section Area (m²)
 (11 x 680 m³/min) ÷ 40.32 m² = **186.0 m/min or 3.00 m/s**
 (11 x 24,000 ft³/min) ÷ 425 ft² = **620 fpm**

Improving airspeed distribution in breeder houses

Airspeed Distribution - Mechanical Nest Boxes

In full tunnel ventilation mode, the air moving down the production house will always find the path of least resistance. Airspeed distribution can be challenging in breeder production houses due to the presence of equipment. The placement of feed distribution hoppers and the orientation of nest boxes plays a major role in airspeed uniformity across the house cross section.

- ✓ In USA type breeder houses, with a central scratch area, the air velocities on the slats are typically 15 to 25 % lower than the center air velocity in the scratch area.
- ✓ Low slat air velocities result in significantly less bird-heat removal. Scratch areas can be significantly cooler. Further, increasing tunnel fan capacity or velocity will increase this differential, with the greatest improvements always seen in the scratch area.
- ✓ Airspeeds are always the lowest against the side walls.
- ✓ Prevent using exposed structural posts on the side walls. Smooth, solid side walls instead of curtains will improve slat airspeeds.

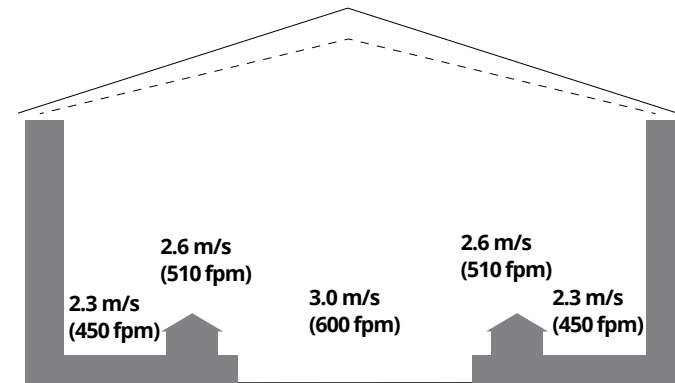

An example of typical airspeed distribution for a US style production house

Community Nest Setup Airspeed Distribution

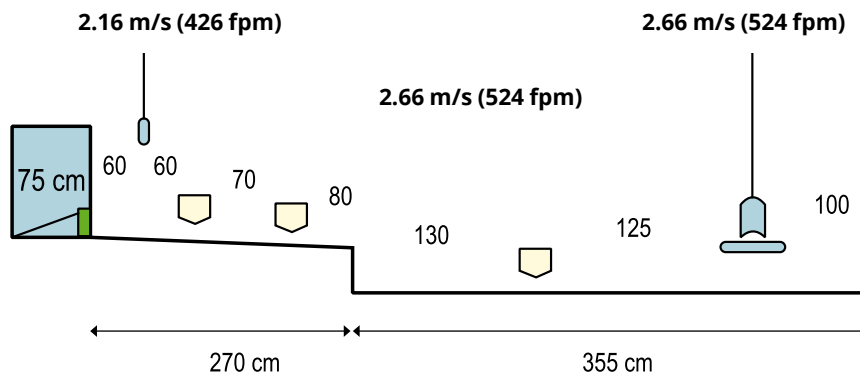

An example of typical airspeed distribution for a community nest production house. The diagram represents half of a 14 m (46 ft).



Airspeed uniformity is also affected by the height differential between the drop ceiling or roof and the scratch and slat areas. Prevent large differences in height between slat and the ceiling (A) compared with the scratch area and the ceiling (B).

14.9 Evaporative Cooling

The primary role of the evaporative cooling system is to maintain house temperature below 28.0 °C (82.4 °F). Enough pad area needs to be installed so fan performance is not severely reduced. For every 1 °C cooling due to the evaporative cooling system, the % RH of the air will increase approximately 4.5 %. (1 °F = 2.5 % RH increase).

Evaporative pad management

- ✓ All fans should be on before operating cooling pads!
- ✓ The use of evaporative cooling should be evaluated for its effectiveness when outside RH is above 75 %.
- ✓ Pads should not be used at temperatures below 28 to 29 °C (82 to 84 °F).
- ✓ House humidity not to exceed 85 to 90 %.
- ✓ Do not use fogging in conjunction with pads if RH is above 75 %.
- ✓ Generally, pads are used from 9 AM to 6 PM due to natural daily humidity cycles – Nighttime operation will increase heat stress.
- ✓ Pad system should be flushed weekly.
- ✓ Monitor water quality and pH. Maintain hardness levels below 110 ppm and pH in the sump between 7 and 9. Bleed off the system continuously as per manufacturers recommendations. Higher levels of salts will require more frequent bleed-off.
- ✓ Do not use pads on a timer cycle to prevent excessive scale buildup on the pad surface.
- ✓ Do not use evaporative cooling before 25 days of age. Only during extremely high temperatures, should pads be used with chicks in the first two weeks. Wetting of the pads must be limited with an interval timer. Pads are used only to temper the incoming air.
- ✓ Do not cycle the pumps in areas with high levels of salt in the ground water. Continuous drying of the surfaces of the pads will result in rapid formation of scale on the pad surfaces.
- ✓ Only use chemicals recommended by the manufacturer.
- ✓ DO NOT ADD CHLORINE OR BROMINE.
- ✓ Refer to manufactures guidelines.

Common ventilation causes of wet litter and high humidity

- ✓ High stocking densities due to bird migration – too many birds in the cool pad area.
- ✓ Excessive running of the evaporative (cool cell) pumps with too low air exchange rates – all tunnel fans should be on.
- ✓ Running the evaporative (cool cell) pumps when temperature is below 28.0 °C (82.4 °F).
- ✓ Running the evaporative (cool cell) pumps when relative humidity outside the house is above 75 %.



Evaporative pad cooling potential

The table is an example of an evaporative cool pad with an efficiency rating at 75 % and it's potential cooling capacity over a range of outside temperatures and relative humidity levels. In the table (right), colored cells indicate cooling potential as follows:

Blue - acceptable cooling

Yellow - marginal cooling

Red - insufficient cooling

For every 1°C of cooling produced by the evaporative cooling system, the % RH of the air will increase approximately 4.5 % (1 °F = 2.5 % RH increase).

Two Examples – external ambient temperature 32°C and external relative humidity at 30 and 60 %.

A.

32 °C and 30 % RH:

Potential reduction in house temperature is 9.4 °C

Added humidity: 4.5 % × 9.4°C = 42 %

New combined inside humidity: 30% (outside) + 42 % = 72 %

B.

32 °C and 60% RH:

Potential reduction in house temperature is 4.7 °C

Added humidity: 4.5 % × 4.7°C = 21 %

New combined insde humidity: 60 % (outside) + 21 % = 81 %

Outside % RH	Expected Cooling Produced by 15 cm (6 in) Pad System													
	27	28	29	30	31	32	33	34	36	37	38	39	40	
100	27	28	29	30	31	32	33	34	36	37	38	39	40	
95	26	27	28	29	31	32	33	34	35	36	37	38	39	
90	26	27	28	29	30	31	32	33	34	36	37	38	39	
85	25	26	27	28	29	31	32	33	34	35	36	37	38	
80	24	26	27	28	29	30	31	32	33	34	35	36	37	
75	24	25	26	27	28	29	31	31	32	33	34	36	37	
70	23	24	26	27	28	29	29	31	32	33	34	35	36	
65	23	24	25	26	27	28	29	30	31	32	33	34	35	
60	22	23	24	26	26	27	28	29	31	31	32	33	34	
55	22	23	24	24	26	27	28	28	29	31	32	33	33	
50	21	22	23	24	25	26	27	28	29	30	31	32	33	
45	21	21	22	23	24	25	26	27	28	29	30	31	32	
40	20	21	22	23	23	24	26	26	27	28	29	30	31	
35	19	20	21	22	23	24	24	26	27	27	28	29	30	
30	18	19	20	21	22	23	24	25	26	27	27	28	29	
25	18	18	19	21	21	22	23	24	25	26	27	27	28	
20	17	18	19	19	21	21	22	23	24	25	26	27	27	
15	16	17	18	19	19	21	21	22	23	24	24	26	27	
10	16	16	17	18	19	19	21	21	22	23	24	24	26	
5	14	16	16	17	18	19	19	21	21	22	23	23	24	
0	14	14	16	16	17	18	19	19	20	21	22	23	23	
	27	28	29	30	31	32	33	34	36	37	38	39	40	

Water Meters

Monitoring water consumption with water meters is an excellent means of gauging feed consumption, as the two are highly correlated. Do not use oversized meters that require significant flow rates to register consumption, which is especially relevant during the 1st few weeks. Water meters should be sized the same as the incoming water supply line to ensure adequate flow rate. Water consumption should be evaluated at the same time each day to determine general performance trends and bird well-being.

Water consumption per bird should be recorded every 24 hours. Any substantial change in water usage should be investigated as this may indicate a water leak, health challenge or feed issue. A drop in water consumption is often the first indicator of a flock problem.

Note: Install a water meter bypass, used during flushing – water used during regular flushing procedures should not be included in the daily water intake reading.



25 mm (1 in) medicator valves

25 mm (1 in) water meter

25 mm (1 in) pressure regulator

Water Storage Tanks

Adequate water storage should be provided on the farm in the event that the main system fails. A farm supply of water equal to the maximum 48 hour demand is ideal. The storage capacity is based on the volume of water for the number of birds required for the evaporative cooling system. When designing or upgrading a farm, understanding water supply and layout is critical. Separate water supplies for the birds and cooling systems should be installed in each house. Take into account the peak drinking demand requirements and evaporative cooling system demand. Storage tanks should be housed in a separate insulated building, or alternatively shaded and insulated. If the source of water is a well or holding tank, the supply pump capacity should match the birds' maximum water consumption and also the maximum needs of the fogging and/or evaporative cooling systems.

The diagram to the right is an example of the water supply layout for a 4 house farm

Pump pressure at source: 3.5 to 4 bar (50 to 60 psi)

A = 75 mm (3 in) pipe diameter and 300 l/min

B = 50 mm (2 in) pipe diameter and 150 l/min

C = 40 mm (1.5 in) pipe diameter and 75 l/min

Control room: 2.8 bar (40 psi) - minimum

Drinkers: 2 bar (30 psi)

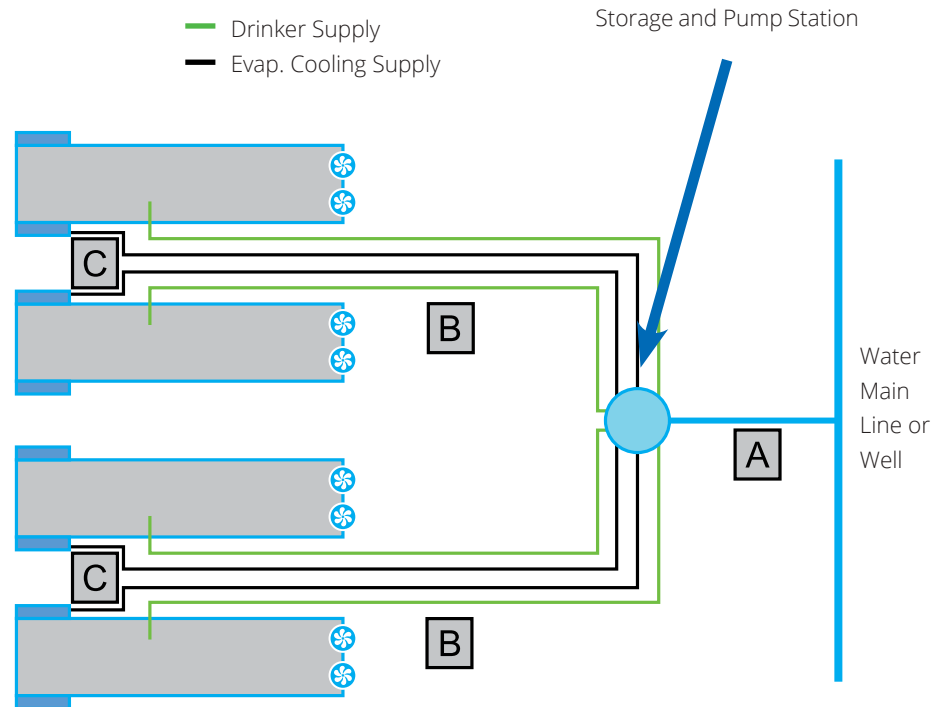

Estimated flow rates for different pipe sizes						
Pipe Diameter	20 mm (0.75 in)	25 mm (1.0 in)	40 mm (1.5 in)	50 mm (2.0 in)	65 mm (2.5 in)	75 mm (3.0 in)
Flow rate (l/min)	20	38	76	150	230	300
Flow rate (gal/min)	5.3	10.0	20.0	40.0	60.8	79.3

Evaporative cooling pad water requirements will depend on outside temperature and relative humidity. The table (below) is an example of how evaporative pad water requirements increase with a drop in relative humidity at 35 °C (95 °F).

15 cm (6 in) Evaporative Pad Water Requirement at 35 °C (95 °F) per 2832 m ³ /min (100,000 cfm)				
Humidity	50 %	40 %	30 %	20 %
Flow rate (l/min)	10	12	14	17
Flow rate (gal/min)	2.6	3.2	3.7	4.5

The following table is an example of the maximum cooling pad water requirement of a modern tunnel ventilated house operating at an airspeed of 3 m/s (600 fpm).

15 cm (6 in) Evaporative Pad Water Requirement Pads evaporate 10 l/min per 100,000 cfm (2.6 gal) or 170,000m ³ /hour at 35°C (95°F) at 50 % RH								
House Width		Air Speed		Tunnel Fan Capacity		No Fans	Pad Requirement	
m	ft	m/s	fpm	m ³ /min	cfm	(790 m ³ /min or 28,000 cfm)	l/min	gal/min
12	40	3	600	6456	228,000	8	45	11.9
15	50	3	600	8093	285,800	10	53	14.0
18	60	3	600	9684	342,000	12	64	16.9
20	66	3	600	10653	376,200	13	72	19.0

14.10 Light Trap Function and Installation

Designing a ventilation system for a dark out tunnel ventilated rearing house can be challenging. There are many different models and designs of light traps available, each with different light restriction capacities. The air flow restriction does not necessarily correspond with the light reduction factor. Some very high light reducing traps have very low air flow restrictions. The required house air velocity and the fan capacity will dictate the area of light trap needed.

Light traps or light filters can be compared in terms of two criteria:

1. Resistance to air flow:

Resistance to air flow is presented in graphical format with static pressure (pascal or inches water) plotted against light trap face velocity in m/s or fpm. When comparing light traps at a given face velocity, a lower static pressure will indicate a lower air flow resistance.

2. Resistance to light transmission:

Test facilities will place high wattage lamps outside the light traps to simulate direct sunlight. Light intensity is measured at the outside and inside surfaces of the light traps. The light reduction factor is calculated by dividing the outside light intensity by the inside light intensity.

When comparing different light traps/filters, the higher the light reduction factor, the greater the resistance to light transmission. The light trap should have a light reduction factor of at least 2,000,000 to one. Ideally it should be in excess of 10,000,000 to one. An excellent reference can be found at <http://bess.illinois.edu/pdf/Lighttraps.pdf>

Some general light trap installation and management tips:

- ✓ Light traps are usually available in cellular or blade type (photo right blade type).
- ✓ When installing light traps, it is very important to know the pressure drop across the light trap, to ensure the correct fan capacity is installed to meet the air velocity requirements of the flock.
- ✓ The light trap supplier will supply the expected pressure drops (in wc or Pa) over a range of face velocities (fpm or m/s).



Photo courtesy of Big Dutchman

Light trap installation and management (cont.)

- ✓ The airspeed through the light trap (face velocity) will always depend on the area of the light trap installed.
- ✓ Light traps placed directly over fans will cause a significant drop in fan performance, thus they are not the best option in a high-speed tunnel houses (image right).
- ✓ In a cross ventilated pullet house, a 150 cm × 150 cm or 2.25 m² (60 in x 60 in or 25 ft²) light trap can be placed directly over a standard 120 cm fan (48 in).
- ✓ When installing both tunnel inlet light traps and evaporative pads in a pullet rearing house, the tunnel inlet light traps can have a lower light reduction factor and lower air flow resistance than those installed at the tunnel fan end, due to the light reduction factor offered by the evaporative pads and a darkened dog house (painted black or the use of shade cloth).
- ✓ An efficient installation option for the tunnel fan light traps, is to construct a false wall that incorporates the light traps, placed 1.5 m (5 ft) from the tunnel fan end (image right). This allows air to pass through all light traps reducing the pressure drop when the house is not in full tunnel mode.
- ✓ An alternative is to install the tunnel fans on the sides of the house, each with a plenum type room (doghouse) for the installation of the light trap false walls (image below left). This is by far the most efficient, since fan and light trap area requirements in high speed rearing houses usually require more light trap area than can fit into the house cross section.



Light traps mounted over fans can reduce fan performance, and are not the best option in a high-speed tunnel houses.



Light trap in a false wall in front of tunnel fans.



Tunnel fan light trap false wall installed in "dog house" or plenum in front of tunnel fans installed on the sides of the house.



Tunnel inlet light trap.

Appendices

Male Rearing Checklist

Female Rearing Checklist

Male Production Checklist

Female Production Checklist

Egg Production and Quality Checklist

Measurements and Conversions

Abbreviations

Breeding Farm Contacts

Male Rearing Checklist

Question	Target	Actions	Reference
Are male bodyweights and uniformity on standard at 7 days of age?	Target body weight range: 145 to 150 g.	Perform a 100 % weighing and grading when the flock is 7 to 14 days old.	Chapter 8. Bodyweight Control, Weighing and Analysis
Are males meeting bodyweight targets during grading at 4, 8, 12 and 16 weeks?	Males should follow Cobb's standard weight curve.	Select males for minimum bodyweight at 7 days and 4, 8, 12, and 16 weeks, and production. Separate the heaviest and lightest males at 3 to 4 weeks. At 4 weeks, remove males 25% below standard. At 8 weeks, handle all males and remove those below quality standards.	Chapter 10. Male Management
Are males meeting and maintaining Cobb uniformity targets?	Bodyweights can vary +5 % compared to the 4-week standard.	Attempt to get males back on standard bodyweight by 8 weeks of age.	Chapter 8. Bodyweight Control, Weighing and Analysis
Are male rearing stocking densities (males/m ²) on Cobb standard (very important from 12 weeks of age)?	Open sided rearing: 2.5 males/m ² or 4.3 ft ² /male. Dark out rearing: 3.0 males/m ² or 3.6 ft ² /male.	Adjust stocking densities to meet Cobb standards.	Sec 2.2. Brooding Design and Management.
Is feed weighing accurate?	An accurate and regularly calibrated feed weighing system is essential.	Scales must be calibrated before each new flock. Monitor weighing procedure and feed cleanup times.	Feeder Checks Page 17. Feed intake page 31.
Is male feeder space correct?	See the recommended progressive feeder space table for Cobb males in rearing page 36.	Calculation based on diameter and circumference of pan. If your feeder pan has a different diameter, please check with Cobb technical representative for feeder space calculation. Make sure feeders are specifically designed for males.	Feeder space page 36.
Is feeder height correct from 5 to 16 weeks?	The height of the feeder system is important for all the males to eat comfortably.	Adjust to a height so that smaller males can still eat.	Section 10.4. Male Feeding – Separate Sex Feeding
Are the Cobb male rearing drinker space and water quality standards met?	8 to 10 birds per nipple or 75 birds per bell drinker.	Monitor drinkers for signs of low water pressures or blocked nipples and correct height. Test water at least annually.	See chapter 7 for water quality standards
Are enough males in a rearing flock reserved for spiking?	12 to 14 % of males, compared to females, are reserved for spiking in each parent stock flock coming out of rearing.	Adjust numbers of males retained for spiking.	Section 10.6. Spiking Males During Production
Are the males the correct age and in the correct condition at photo stimulation?	Fleshing score of 2.5 to 3.0 with an age of minimum 25 weeks and bodyweight of 4.0 kg.	Focus on breast condition and monitor bodyweight increases g/bird/day to make decision on when to photo stimulate.	Section 10.3. Male Fleshing or Breast Conformation

Male Rearing Checklist (cont.)

Question	Target	Actions	Reference
Are primary males transferred to the production house at the correct time?	Transfer males to production farms at least 2 to 3 days before females if sexual synchronization is correct between the sexes.	Select enough males for a female/male ratio of 8 to 9% in houses with slats, and 9 to 10 % in houses without slats.	Section 10.2. Transferring Males to Production Houses
Is the house free of sanitary problems that could compromise rearing quality?	Daily mortality will vary based on flock age.	Record daily mortality and culls, be aware of any increases that may be related to disease. Notify supervisor or veterinarian so that health samples can be collected to verify health status of the flock.	Chapter 1. Biosecurity on the Farm
Is the house environment (air quality, temperature) optimal?	Air quality and temperature management guidelines in the ventilation section page 118.	Air quality guidelines in table on page 118.	Chapter 14. Ventilation Management
Is the litter quality good and well maintained?	Litter should be dry with no caking.	Maintain humidity below 60 to 65 %	Chapter 14. Ventilation Management. Chapter 7. Water Management
Is the Cobb rearing lighting program being used?	See the lighting program on page 23.	At 4 days of age, start reducing the light period and intensity to 8 hours of light after 14 days.	Page 23 – Lighting (rearing)

Female Rearing Checklist

Question	Target	Actions	Reference
Are female bodyweights and uniformity on standard at 7 days of age?	Target bodyweight range: 150 to 160 g. Target flock average uniformity is $\geq 80\%$.	Perform a 100 % weighing and grading when the flock is 7 to 14 days old.	Chapter 8. Bodyweight Control, Weighing and Analysis
Are females selected between 7 to 14 days?	Perform a 100% weighing and grading when the flock is 7 to 14 days old.	Classify chicks in heavy, average, lightweight and super light- weight categories.	Chapter 9. Methods for Grading Breeders
Is the average flock weight at 28 days on standard?	Flock should be on standard weight on the 4th week of age (max +/-2%).	Perform 100 % flock gradings at 4, 8 and 12 weeks of age or when uniformity is below 65 %.	Chapter 9. Methods for Grading Breeders
Are bodyweights on the Cobb's standard throughout rearing?	See the breeder supplement for target weights.	Perform weighing weekly with manual or automatic scales.	See the Cobb breeder supplements for target weights. Chapter 9. Methods for Grading Breeders
What is uniformity in weeks 1, 4, 8 and 12?	Uniformity in rearing should be above 70 % ($\pm 10\%$ variation of the mean) from 3 to 20 weeks.	Perform 100 % flock gradings at 4, 8 and 12 weeks of age or when uniformity is below 65 %.	Chapter 9. Methods for Grading Breeders
Are females in the light (<10 % of average) and super light (<20 % of average) categories being recovered correctly?	See bodyweight correction curves in chapter 8.	Increase feed amount based on percentage of bodyweight below the standard and increase feed allocation the same percentage for 2 weeks to recover bodyweight development until 8 weeks of age.	Chapter 8. Bodyweight Control, Weighing and Analysis
Are the fleshing score targets on standard at key ages of 12, 16, and 20 weeks in preparation for photo stimulation?	See table of goals for flock percentage (females only) with fleshing score (2 to 4) and pelvic fat based on flock age – Section 4.4.	The fleshing evaluations can be combined with pullet weights at specific ages to determine if the flock is on target.	Section 4.4 Phase 4 - Controlled Growth (12 to 16 weeks) Section 4.5 Phase 5 - Accelerate Growth (16 to 20 weeks)
Is feed weighing accurate?	Scales must be calibrated before each new flock.	Monitor weighing procedure and feed cleanup times.	Page 17 - Feeder Checks Page 31 - Feed intake
Is the required feeder space met through-out rearing?	See page 36 for the recommended progressive feeder space .	Gradually increase feeder space after placement, based on bird age and the feed amount needed to cover the entire feed track.	Page 36 - recommended progressive feeder space for Cobb females
Is the target feed distribution time achieved?	Feed distribution should be less than 3 minutes and done in the dark.	Check equipment to ensure it is functioning correctly.	Page 36 - recommended progressive feeder space for Cobb females
Is the developer feed balanced to ensure both weight gain, conformation and fat deposition?	See supplements for specific nutrition recommendations.	Use this feed until 1st egg or 5% production.	Page 32 - The importance of nutrition
Is the Cobb rearing lighting program being used?	See the lighting program on page 23.	At 4 days of age, start reducing the light period and intensity to 8 hours of light after 14 days.	Page 23 – Lighting (rearing)
Is light intensity and uniformity sufficient and correct?	Light uniformity above 75 %.	In rearing, 2 to 4 lux (0.2 to 0.4 fc).	Page 23 – Lighting (rearing)

Female Rearing Checklist (cont.)

Question	Target	Actions	Reference
Are weights uniform in each pen after selection according to standard?	Target pen uniformity of > 90 % and CV below 6 %.	Expect uniformity to decline to a normal level of 70 to 72 % as pecking (social) order and feed competition become re-established within pens. If after the first sorting, uniformity drops to 65 % or below, perform an additional sorting and grading.	Chapter 9. Methods for Grading Breeders
Is bodyweight highly variable?	Flock uniformity greater than 70 %.	Be sure to maintain good feed uniformity intake by conducting crop checks after feeding. Observe feed cleanup time. Check feeder heights.	Chapter 4. Breeder Management
Is the accelerated weight gain between 16 and 20 weeks satisfactory?	A minimum bodyweight increase of 36 % is needed from 16 to 20 weeks.	Increase feed allocations a minimum of 42 % (or 6 % higher than the bodyweight increase).	Section 4.5 Phase 5 - Accelerated Growth (16 to 20 weeks)
Are the uniformity and CV on target at transfer?	Acceptable minimum uniformity at transfer of >70% with a CV <10 %.	See bodyweight control, weighing and analysis, and methods for grading breeders – chapters 8 and 9.	Section 4.7 Breeder Flock Transfer
Are pullets photo stimulated at the right time ?	First light stimulation should be between 147 (2.5kg) and maximum 154 days of age depending on conditioning and fleshing.	Sample at least 3 % of flock (minimum of 50 birds) and measure weekly weights.	Section 4.9 Preparation for Photo Stimulation (20 to 24 weeks)
Are pullets photo stimulated when they have the correct fat deposition and fleshing?	95 % of the hens should have a fleshing score of 3 to 4, and 85 % with pelvic fat or a prominent fat vein.	If fat deposition is not adequate, delay light stimulation. Review program for future flocks.	Section 4.9 Preparation for Photo Stimulation (20 to 24 weeks)
Are the Cobb female rearing drinker space and water quality standards met?	8 to 10 birds per nipple or 75 birds per bell drinker.	Monitor drinkers for signs of low water pressures or blocked nipples and correct height. Test water at least annually.	See chapter 7 for water quality standards
Is the house free of sanitary problems that could compromise production quality?	Daily mortality will vary based on flock age.	Record daily mortality and culls, be aware of any increases that may be related to disease. Notify supervisor or veterinarian so that health samples can be collected to verify health status of the flock.	Chapter 1. Biosecurity on the Farm
Is the house environment (air quality, temperature) optimal?	Air quality and temperature management guidelines in the ventilation section page 118.	Air quality guidelines in table on page 118.	Chapter 14. Ventilation Management
Is the litter quality good and well maintained?	Litter should be dry with no caking.	Maintain humidity below 60 to 65 %.	Chapter 14. Ventilation Management. Chapter 7. Water Management

Male Production Checklist

Question	Target	Actions	Reference
Are Cobb male production stocking densities (males/m ²) being used?	In general, at transfer, select enough males for a female/male ratio of 8 to 9 % in houses with slats, and 9 to 10 % in houses without slats.	The male to female ratio will depend on sexual synchronization and male cross.	Section 10.2 Transferring Males to Production Houses
Are male feeder spacing requirements correct?	20 cm (7 7/8 in) of spacing per male for chain feeders or 8 males per round feeder or 10 males per oval feeder.	Ensure exclusion systems on female feeder are correct and the feeder height of the feeder system for all the males to eat comfortably. Normally apply a height that is close to the upper crop height of the males.	Section 10.4 Male Feeding – Separate Sex Feeding
Is feed weighing accurate?	An accurate and regularly calibrated feed weighing system is essential.	Scales must be calibrated before each new flock. Monitor weighing procedure and feed cleanup times.	Feeder Checks Page 17. Feed intake page 31.
Is male feed evenly distributed in feeders?	Feed should be distributed to all pans simultaneously or the throughout the feed trough in less than 3 minutes.	Feed distribution to be done in the dark if possible or while feed lines are winched up, prior to turning lights on. Male feeding system lowered after all females are eating.	Section 10.4 Male Feeding – Separate Sex Feeding
Is feed consumption in line with Cobb standard in terms of g/bird/day?	Refer to Cobb supplements for our male lines.	Consult your Cobb Technical Representative to develop a feeding plan if the Cobb standard is not working for your operation due to excess feed stealing.	Refer to Cobb supplements for our male lines.
Are the energy and crude protein levels in the correct male diet?	Male diets with metabolizable energy levels around 2,700 kcal (11.25 MJ) and 13 % of crude protein & 0.50 % dig. lysine.	Check feed formulation.	Section 10.5 Male Weight Trends During Production
Are males receiving the correct energy increase in the male feed from 24 to 30 weeks?	Week 24 to 30 increase feed energy from 320 to 350 kcal (1.33 to 1.46 MJ) to prevent loss of conditioning and mortality increases.	Refer to Cobb Supplements for male feed formulations.	Section 10.5 Male Weight Trends During Production
Are the males eating from the female feeders?	Restrict male access to female feeders.	Train the males to eat from their feeding system and determine the best male feeding program to peak production.	Section 10.4 Male Feeding – Separate Sex Feeding
Are males in production selected correctly and at the correct time?	Fixed program to evaluate the quality of the males constantly.	Every 2 weeks in the afternoon, remove all males incapable of mating or out of semen production.	Section 10.1 Male Rearing
Male breast conformation correct?	Keep fleshing scores between 2.5 and 3.0 increasing slowly over time.	Evaluate male breast condition together with weekly weighing or every 2 weeks.	10.3 Male Fleshing or Breast Conformation

Male Production Checklist (cont.)

Question	Target	Actions	Reference
Are intra-spikings performed at the correct time?	Intra-spiking can be done every 4 weeks when the flock is >35 weeks of age. Categorize males into groups by breast conditions (2 to 2.5 medium fine and 2.5 to 3 medium full) or by bodyweight (light, medium and heavy) categories.	Remove all primary males meeting quality standards from a single house or pen, and intra-spike with the other houses or pens on the same farm.	Section 10.6 Spiking Males During Production
Are unproductive males removed from the flock?	Unproductive males cannot stay in the flock and need to be removed immediately.	Remove unproductive males during the entire production phase consistently (every 2 weeks).	Section 10.6 Spiking Males During Production
Are testicle weights correct based on bodyweight?	At 28 weeks of age, males need an average of ≥ 40 g of testicle weight or ≥ 1 % of bodyweight.	If excess males are available evaluate bodyweight and testicle weights to confirm that males are on standard.	See Cobb supplements for male lines
What are weekly hatch and fertility trends?	See the breeder supplement for target hatch and fertility rates.	Continue to evaluate flock fertility and hatch. These results should not alter basic male management practices.	See the Cobb breeder supplement for target hatch and fertility rates
Is hatchability below the standard?	See the breeder supplement for target hatch and fertility rates.	Use spiking and inter-spiking methods to improve fertility and hatchability.	Section 10.6. Spiking Males During Production
Is the house environment (air quality, temperature) optimal?	Air quality and temperature management guidelines in the ventilation section page 118.	Follow air quality guidelines in table on page 118.	Chapter 14. Ventilation Management
Is the litter quality good and well maintained?	Litter should be dry with no caking.	Maintain humidity below 60 to 65 %.	Chapter 14. Ventilation Management. Chapter 7. Water Management
Are the Cobb drinker space and water quality standards met?	8 to 10 birds per nipple or 75 birds per bell drinker.	Monitor drinkers for signs of low water pressures or blocked nipples and correct height. Test water at least annually.	Chapter 7. Water Management

Female Production Checklist

Question	Target	Actions	Reference
Is the correct feeding program followed from onset of lay to peak	The maximum feed amount will depend on the feed form and energy value, typically between 435 and 470 kcal (1.81 to 1.95 MJ).	Ensure quality feed ingredients are being used for flocks going into peak production. Apply the latest Cobb recommended feed specifications to maximize egg production.	See Cobb supplements for our female lines
Feeder space requirement?	Minimum of 15 cm of chain feeder per female per side of chain feeder.	Adjust chain feeder space to 15 cm per female on each side of the chain feeder.	Page 36 – Feeder Space Recommendations
Is feed weighing accurate?	An accurate and regularly calibrated feed weighing system is essential.	Scales must be calibrated before each new flock. Monitor weighing procedure and feed cleanup times.	Feeder Checks Page 17 Feed intake page 31
Is the female feed evenly distributed throughout the feeders?	Feed should be distributed to all birds throughout the house in less than 3 minutes and preferably in the dark.	Check feed distribution. Check equipment to ensure it is functioning correctly.	Section 5.3 Feeding Hens after Transfer and in Production: Early and Late Morning Feeding
Are feed cleanup times in production correct for the feed presentation type?	For crumble feed: Chain feeder: 1.5 to 2 hours Feeder pans: 2 to 2.5 hours For mash feed: Chain feeder: 2 to 3 hours Feeder pans: 3 to 4 hours.	Be present during feeding time to measure cleanup times.	Page 31 – Feed Intake
Are the feed nutrient values (Energy, Crude protein, Lysine) correct throughout production and feed allocations are adjusted with hens' productivity and weight?	Apply the peak production feeding concept from start to peak production.	40 % of the difference in total feed increase is given from 5 % until 45 % daily production and 60 % of the feed allocation between 40 and 80 % production.	Chapter 5 – Female Feed Management: from Photo Stimulation to Peak Production
Is hen body weight highly variable (poor uniformity)?	Flock uniformity greater than 70 %.	Be sure to maintain good feed uniformity intake by conducting crop checks after feeding. Observe feed cleanup time. Check feed heights.	Page 31 – Feed Intake Section 5.1 Female Feed Management from Photo Stimulation to Onset of Lay
Are hens weighed weekly?	Weigh 1 to 2 % of the flock or 60 to 100 birds weekly through week 40.	Calculate bodyweight and record fleshing scores. Adjust feed allocations accordingly.	Chapter 5. Female Feed Management
Is the flock production on target at 25 weeks?	Target production is between 2 to 5 %.	Delays in production are primarily due to incorrect bodyweights and fleshing at photo stimulation. Check feed specifications, feeding program, bodyweights, and lighting program.	Section 4.9 Preparation for Photo Stimulation (20 to 24 weeks)
Is cumulative mortality below standard between 25 and 32 weeks?	Below 2.47 %.	Check the feeding program for over stimulation. Use correct feed formulation. Synchronize male and female maturity with correct mating ratio. Do not overfeed.	Section 5.2 Feeding and Its Influence on Weekly Mortality Trends
Is the feed reduction percentage post peak through end of production correct?	Target reduction of 7 % to 10 %.	Periodic handling of the hens, along with weighing to determine reductions in feed amounts.	Section 5.5 Post Peak Feeding – Feed Reduction

Female Production Checklist (cont.)

Question	Target	Actions	Reference
Is the minimum light intensity sustained during production?	Minimum of 50 to 70 lux throughout light period.	Light intensity is important to encourage male activity. If feather pecking occurs intensity can be reduced as emergency procedure.	Chapter 6. Lighting Program Management
Is light intensity and uniformity sufficient and correct?	Light uniformity above 75 %.	Minimum of 50 lux (5 fc) and ideally 70 lux (7 fc).	Chapter 6. Lighting Program Management
Is the house free of sanitary problems that could compromise production quality?	Daily mortality will vary based on flock age.	Record daily mortality and culls, be aware of any increases that may be related to disease. Notify supervisor or veterinarian so that health samples can be collected to verify health status of the flock.	Chapter 1. Biosecurity on the Farm
Is the house environment (air quality, temperature) optimal?	Air quality and temperature management guidelines in the ventilation section page 118.	Air quality guidelines in table on page 118.	Chapter 14. Ventilation Management
Is the litter quality good and well maintained?	Litter should be dry with no caking.	Maintain humidity below 60 to 65 %.	Chapter 14. Ventilation Management Chapter 7. Water Management
Are the Cobb drinker space and water quality standards met?	8 to 10 birds per nipple or 75 birds per bell drinker.	Monitor drinkers for signs of low water pressures or blocked nipples and correct height. Test water at least annually.	Chapter 7. Water Management

Egg Production and Quality Checklist

Question	Target	Actions	Reference
Is the correct nesting space used?	Birds per m ² will depend on the type of nesting system, feeder space, house width and ventilation capacity. In general: Manual =4 hens, Individual Mechanical = 5.5 hens per nest Community =200 to 260 per nest	Follow manufacturer and Cobb recommendations for nesting space.	Section 4.6 House Preparation for Transfer and Production
Is nest cleanness and disinfection according to Cobb's standard?	Keep nest pads clean, litter in good dry condition and slats dry.	Dirty eggs in both mechanical and manual collection systems are a sign of dirty nest pads or nesting material. Have 20% extra nest pads available as replacements so that nest pads can be re-moved, cleaned and replaced on a regular basis.	Section 12.3 Egg Hygiene
Is the bedding amount in the nest correct?	Fill the nests with material that is a minimum 1/2 to a maximum 2/3 of the instep height for the hen to make a concave nest.	Measure bedding amount and adjust if necessary.	Section 4.6 House Preparation for Transfer and Production
Is litter depth correct in the scratch area?	Litter depth will depend on the type of floor and nesting system.	Too much litter placed in the floor area can result in increased floor eggs, especially with community nests. Measure the litter depth and reduce by 2 to 3 cm (3/4 to 1 in).	Page 106 - Causes of and possible solutions for floor eggs
Are egg conveyor belts clean?	All egg belts should be free of organic matter as dirty egg belts can discourage hens from using the nests.	Dirty egg belts are a sign of hygiene issues. Clean nest pads. Keep belts clean and free of organic material.	Section 12.3 Egg Hygiene
Are nest belts activated consistently and in a manner that prevents disrupting hens in nests?	Belts should be activated (normally) in afternoon in order not to scare the females.	Activate nests at the same time every day. Ensure the plastic flaps are not curled or damaged so hens cannot see the moving belt.	Pages 99 to 100 - Egg belt speeds and timing
In the first weeks after transfer, do staff members walk through the house?	Females should be able to jump onto slats. Depending on nesting system, walk through the house 3 to 8 times/day beginning 1 week before production starts.	Train females correctly in rearing to be active and mobile so that they can easily jump onto the slats to access the nests.	Section 4.7 Breeder Flock Transfer
In the early production, are manual nests always on the floor and raised gradually after 28 weeks?	Depending on the cross, gradually increase the manual nest system height.	Train females correctly in rearing to be active and mobile so that they can easily access the nests.	Page 47 - Manual nesting systems
Are eggs from manual nests being collected at a minimum frequency per day?	Minimum of at least 6 collections per day.	Minimum of at least 6 collections per day.	Section 12.1 Egg Collection
Are floor eggs being collected at a minimum frequency per day?	Minimum of at least 3 floor egg collections daily until production peak but depends strongly on how many floor eggs are produced.	Increase number of daily collections if necessary.	Page 106 - Causes of and possible solutions for floor eggs

Egg Production and Quality Checklist (cont.)

Question	Target	Actions	Reference
Does egg classification and quality criteria follow Cobb's standards?		See hatching egg grading guide page 102 to 103	
Is egg disinfection process and cleaning of floor eggs adequate?		See egg hygiene recommendations on page 102	
Is egg color normal and uniform?	After 28 weeks uniformity of HE needs to be > 88%. Egg color is related to the genetic line.	Check female uniformity of frame size in first 8 weeks of production.	Section 5.4 Bodyweight In-crease from Onset of Lay to Peak Production
Is eggshell density checked regularly?	Specific gravity should range from 1070 to 1085.	Measure shell quality at least monthly. Communicate with hatchery regarding egg moisture loss.	Section 12.5 Eggshell Quality
Does the packaging of eggs in the farms meets Cobb's standards?	Eggs need to be packed dry and without dust or feathers.	Check packing machine, procedures and the egg room conditions.	Page 98 - Egg packing
Is egg transportation to the hatchery climate controlled?	Truck target temperature range: 20 to 23 °C (68 to 73 °F).	Monitor farm storage and transportation temperatures. Use temperature data loggers.	Page 105 - Ideal temperature curve for eggs after laying through storage.
Is egg packaging room sanitary and free of clutter?	Egg packing room should be clean and free of clutter.	Audit and adjust sanitation program for the egg packing room.	Section 12.3 Egg Hygiene
Are egg quality checks conducted on farms and/or hatchery and communicated between the two facilities?	See Breeder Supplements for quality targets based on line and flock age.	Measure eggshell quality at least monthly. Measure egg weights and plot daily. Monitor floor egg numbers daily.	See Breeder Supplements for quality targets based on line and flock age.
Are eggs stored on the farm under the correct conditions?	7 days maximum for farm storage.	Increase number of shipments from the farm to the hatchery.	12.5 Egg Storage
Do egg weight follows Cobb's standards through production?	Egg weight should be within +/-2% of Cobb standard.	Collect 90 eggs after second collection and weigh. Plot and monitor daily egg weights.	Consult Cobb Breeder supplements for egg weights specific to each line.

MEASUREMENTS AND CONVERSIONS

Area

$1 \text{ cm}^2 = 0.155 \text{ in}^2$
 $1 \text{ m}^2 = 1.196 \text{ yd}^2 = 10.7639 \text{ ft}^2$
 $1 \text{ in}^2 = 6.4516 \text{ cm}^2$
 $1 \text{ ft}^2 = 0.0929 \text{ m}^2$
 $1 \text{ yd}^2 = 0.8363 \text{ m}^2$

Length and distance

$1 \text{ mm} = 0.0394 \text{ in}$
 $1 \text{ cm} = 10 \text{ mm} = 0.3937 \text{ in}$
 $1 \text{ m} = 100 \text{ cm} = 1.0936 \text{ yd} = 3.2808 \text{ ft}$
 $1 \text{ km} = 1000 \text{ m} = 0.6215 \text{ miles}$
 $1 \text{ in} = 2.54 \text{ cm}$
 $1 \text{ ft} = 30.48 \text{ cm}$
 $1 \text{ yd} = 0.9144 \text{ m}$
 $1 \text{ mile} = 1.609 \text{ km}$

Weight and mass

$1 \text{ g} = 0.002205 \text{ lb} = 0.0353 \text{ oz}$
 $1 \text{ kg} = 2.2046 \text{ lb}$
 $1 \text{ ton} = 1000 \text{ kg} = 0.9842 \text{ long tons (British)} = 1.1023 \text{ short tons (USA)}$
 $1 \text{ long ton} = 2240 \text{ lb} = 0.9072 \text{ ton} = 907.185 \text{ kg}$
 $1 \text{ short ton} = 2000 \text{ lb} = 1.016 \text{ ton} = 1016.05 \text{ kg}$
 $1 \text{ oz} = 28.35 \text{ g}$
 $1 \text{ lb} = 0.4536 \text{ kg} = 453.5924 \text{ g}$

Flow rate

$1 \text{ m}^3/\text{kg}/\text{h} = 16.016 \text{ ft}^3/\text{lb}/\text{h}$
 $1 \text{ ft}^3/\text{lb}/\text{h} = 0.0624 \text{ m}^3/\text{kg}/\text{h}$
 $1 \text{ m}^3/\text{h} = 0.5886 \text{ cfm}$
 $1 \text{ m}/\text{sec} = 196.85 \text{ ft}/\text{min}$

Energy

$1 \text{ kcal} = 3.97 \text{ BTU}$
 $1000 \text{ kcal} = 4.184 \text{ MJ}$
 $1 \text{ kcal}/\text{m}^3 = 0.1123 \text{ BTU}/\text{ft}^3$
 $1 \text{ kcal}/\text{kg} = 1.8 \text{ BTU}/\text{lb}$
 $1 \text{ ft candle} = 10 \text{ lux}$

Volume

$1 \text{ liter} = 0.22 \text{ Imp gal} = 0.2624 \text{ US gal}$
 $1 \text{ pt (Imp)} = 0.5682 \text{ liter}$
 $1 \text{ pt (USA)} = 0.4732 \text{ liter}$
 $1 \text{ qt (Imp)} = 1.1365 \text{ liter}$
 $1 \text{ qt (USA)} = 0.9463 \text{ liter}$
 $1 \text{ gal (Imp)} = 4.54596 \text{ liter}$
 $1 \text{ gal (USA)} = 3.7853 \text{ liter}$

Temperature

To calculate Celsius from Fahrenheit $(X \text{ }^\circ\text{F} - 32) \times 5/9 = X \text{ }^\circ\text{C}$

To calculate Fahrenheit from Celsius $(X \text{ }^\circ\text{C} \times 9/5) + 32 = X \text{ }^\circ\text{F}$

MEASUREMENTS AND CONVERSIONS

Temperature	
°C	°F
35	95.00
34	93.20
33	91.40
32	89.60
31	87.80
30	86.00
29	84.20
28	82.40
27	80.60
26	78.80
25	77.00
24	75.20
23	73.40
22	71.60
21	69.80
20	68.00
19	66.20
18	64.40
17	62.60
16	60.80
15	59.00
14	57.20
13	55.40
12	53.60
11	51.80
10	50.00
9	48.20
8	46.40
7	44.60
6	42.80
5	41.00
4	39.20
3	37.40
2	35.60
1	33.80
0	32.00
-1	30.20
-2	28.40
-3	26.60
-4	24.80
-5	23.00

birds/m ²	=	ft ² /bird
3.5	=	3.08
4.0	=	2.69
4.5	=	2.41
5.0	=	2.15
5.5	=	1.96
6.0	=	1.82
6.5	=	1.67
7.0	=	1.54
7.5	=	1.43
8.0	=	1.35
8.5	=	1.27
9.0	=	1.20
9.5	=	1.13
10.0	=	1.08
10.5	=	1.02
11.0	=	0.98
11.5	=	0.94
12.0	=	0.90
12.5 birds/m ²	=	0.86 ft ² /bird

birds/m ²	=	ft ² /bird
13.0	=	0.83
13.5	=	0.80
14.0	=	0.77
14.5	=	0.74
15.0	=	0.71
15.5	=	0.69
16.0	=	0.67
16.5	=	0.65
17.0	=	0.63
17.5	=	0.61
18.0	=	0.60
18.5	=	0.58
19.0	=	0.57
19.5	=	0.55
20.0	=	0.54
20.5	=	0.52
21.0	=	0.51
21.5	=	0.50
22.0	=	0.49

Days / Weeks conversion chart			
Days	Weeks	Days	Weeks
0	0	231	33
7	1	238	34
14	2	245	35
21	3	252	36
28	4	259	37
35	5	266	38
42	6	273	39
49	7	280	40
56	8	287	41
63	9	294	42
70	10	301	43
77	11	308	44
84	12	315	45
91	13	322	46
98	14	329	47
105	15	336	48
112	16	343	49
119	17	350	50
126	18	357	51
133	19	364	52
140	20	371	53
147	21	378	54
154	22	385	55
161	23	392	56
168	24	399	57
175	25	406	58
182	26	413	59
189	27	420	60
196	28	427	61
203	29	434	62
210	30	441	63
217	31	448	64
224	32		

ABBREVIATIONS

bodyweight	BW
centimeter(s)	cm
Centigrade	C
coefficient of variation	CV
Colony Forming Units	CFU
cubic feet per minute	cfm
day(s)	d
Fahrenheit	F
feet per minute	fpm
foot (feet)	ft
foot candles	fc
gram(s)	g
gallon(s)	gal
hatching eggs	HE
hour(s)	hrs
inch(es)	in
inch(es) of water column	in wc
Joule(s)	J
kilocalorie(s)	kcal
kilogram(s)	kg
kilowatt(s)	kW

liter(s)	L
Mega Joule(s)	MJ
meter(s)	m
milligram(s)	mg
milliliter(s)	ml
millimeter(s)	mm
minute(s)	min
ounce(s)	oz
Pascals	Pa
parts per million	ppm
per	/
percent	%
pound(s)	lb
pounds per square inch	psi
relative humidity	RH
second(s)	sec
standard deviation	SD
standard error	SE
standard error of the mean	SEM
Total Viable Count	(TVC)

BREEDING FARM CONTACTS

Contact	Name	Telephone Number
Breeder flock manager		
Feed Mill		
Hatchery manager		
Veterinary service		
Equipment supplier		
Electricity services		
Gas services		
Water services		
Cobb representative		
Laboratory manager		
QA / AW support staff		

INDEX

A

air quality 20, 25, 114, 116, 117, 118, 137, 139, 141, 143
alternative feeding program 31, 33, 42
ammonia 112, 116
automatic 29, 47, 75, 76, 77, 83, 84, 87, 102, 138

B

bacteria 6, 59, 70, 71, 72, 73, 74, 113
beak 28, 62, 86
bell drinkers 17, 29, 45, 69, 136, 139, 141, 143, 150, 150
belt 99, 100, 106, 144
biofilm 6, 73, 109
biosecurity 2, 3, 4, 6, 13, 18, 21, 22, 46, 77, 94, 95, 106, 107, 108, 110, 113, 137, 139, 143
Breeder 1 33
Breeder 2 33, 58, 61, 62
brooders 14, 15, 21
brooding 3, 12, 14, 15, 17, 19, 21, 23, 25, 26, 27, 30, 34, 38, 66, 107, 114, 123, 136, 150
brown out 20, 55, 56, 65, 66, 67

C

calcium 33, 58, 59, 70, 72, 74, 103, 104, 112, 150
carbon dioxide 14, 116
catching 37, 76, 87, 107
chain feeder 35, 106, 142
chick distribution 25
chlorine 71, 73, 74, 112
circulation fans 105, 114, 115
cleaning 4, 5, 14, 18, 31, 73, 83, 108, 109, 110, 111, 113, 145
cleanup time 31, 40, 42, 58, 62, 79, 96, 139, 142
coccidiosis 12, 150
condition 28, 33, 34, 37, 38, 42, 43, 44, 46, 50, 51, 52, 53, 54, 62, 64, 69, 75, 77, 80, 87, 88, 89, 90, 92, 93, 94, 114, 136, 140, 144
crop 3, 27, 34, 42, 51, 54, 70, 85, 91, 106, 107, 139, 140, 142, 150
culling 5, 43, 58, 63, 89, 93, 94, 96
CV 64, 78, 79, 82, 84, 85, 139, 148

D

dark out 20, 28, 52, 59, 65, 66, 67, 123, 132
density 19, 20, 28, 33, 38, 40, 47, 48, 49, 50, 84, 86, 145
depletion 33, 92, 107
developer 33, 138, 150
dimmer 63
disease 2, 3, 4, 5, 6, 15, 19, 26, 51, 72, 79, 94, 101, 104, 108, 116, 137, 139, 143
disinfectant 3, 109, 110, 111, 112, 113
disinfection 3, 4, 14, 18, 71, 102, 108, 110, 111, 144, 145
dominant 87, 88, 93, 94, 95
double yolks 54, 64, 68, 101
drinker 17, 18, 20, 21, 28, 29, 43, 45, 46, 49, 51, 69, 70, 73, 74, 84, 106, 130, 136, 139, 141, 143
drinker height 29, 70

E

egg packer 98, 99, 100
eggshell 33, 59, 101, 102, 104, 145
egg weight 33, 62, 75, 96, 100, 101, 104, 145
enrichments 5, 22, 94, 150
evaporative cooling 114, 123, 127, 128, 130
evaporative cool pad 128

F

fans 8, 16, 18, 65, 105, 109, 110, 114, 115, 116, 117, 118, 120, 121, 122, 123, 124, 125, 127, 133
fast feather 33, 60, 62, 67, 150
fat vein 44, 53, 139
feathering 3, 52, 53, 62, 100, 150
Feed 3, 3, 18, 31, 32, 33, 37, 38, 39, 40, 41, 51, 54, 55, 56, 57, 59, 60, 61, 62, 75, 85, 89, 92, 96, 106, 107, 108, 136, 138, 140, 142, 149
feed cleanup 31, 39, 40, 42, 58, 62, 66, 79, 136, 138, 139, 140, 142, 150
feed distribution 17, 37, 39, 40, 42, 58, 59, 79, 82, 91, 106, 126, 138, 142
feeder 5, 17, 18, 20, 21, 23, 34, 35, 36, 37, 40, 45, 47, 49, 50, 51, 58, 62, 79, 82, 84, 87, 88, 91, 106, 136, 138, 139, 140, 142, 150, 151, 152
feeder space 20, 34, 35, 36, 37, 39, 40, 47, 49, 50, 62, 82, 84, 91, 136, 138, 142, 144, 150
feeding programs 38, 39, 40, 41, 42, 54, 55, 150

feed ingredients 32, 55, 142, 144
 feed intake 16, 23, 27, 31, 32, 33, 34, 42, 55, 69, 83, 86, 121, 123, 136, 138, 140, 142, 151
 feed withdrawal 62, 107
 fertility 28, 58, 61, 62, 74, 86, 87, 88, 89, 90, 91, 92, 93, 94, 107, 141
 fleshing scores 38, 43, 44, 87, 89, 90, 140, 142
 flesh scoring 51, 95
 flock transfer 3, 51, 139, 144, 151
 floor eggs 22, 45, 47, 59, 61, 68, 69, 97, 104, 106, 144, 145
 flow rate 27, 28, 29, 70, 129

G

grading 23, 37, 82, 83, 84, 85, 87, 102, 103, 136, 138, 139, 145
 grading and sorting process 84
 grading machines 83, 87
 grower 33, 62, 151

H

hatch 8, 26, 30, 89, 96, 100, 101, 104, 107, 141
 hatchery 2, 3, 12, 28, 52, 86, 98, 101, 102, 105, 108, 145
 heater 14, 16, 151
 hopper 58, 76, 77
 humidity 9, 14, 16, 26, 27, 49, 63, 102, 105, 111, 114, 116, 118, 120, 123, 127, 128, 131, 137, 139, 141, 143, 148

I

inlet 15, 58, 65, 109, 114, 117, 119, 120, 121, 122, 123, 124, 133
 Insect 3, 7, 8

L

LED 63, 66, 67, 68
 light 1, 23, 63, 65, 66, 67, 68, 85, 109, 123, 132, 133, 138, 143
 light intensity 23, 28, 31, 45, 52, 63, 66, 67, 68, 88, 132, 138, 143
 light trap 123, 132, 133

litter 3, 8, 12, 15, 16, 17, 19, 21, 22, 23, 24, 28, 29, 34, 45, 49, 50, 51, 63, 69, 76, 84, 95, 97, 106, 108, 109, 114, 115, 116, 120, 127, 137, 139, 141, 143, 144
 litter moisture 114, 116

M

manual nest 47
 mechanical nest 47
 minerals 33, 70, 111
 minimum ventilation 116, 117, 118, 119, 120, 121
 mites 9
 mortality 2, 3, 5, 7, 8, 11, 22, 28, 30, 33, 42, 44, 45, 51, 54, 55, 56, 58, 63, 64, 68, 72, 89, 93, 94, 95, 96, 97, 101, 105, 120, 137, 139, 140, 142, 143

N

natural daylight 66, 67
 nest 9, 45, 47, 48, 51, 54, 59, 61, 97, 102, 104, 106, 107, 123, 124, 126, 144, 151
 nesting space 49, 144
 nipple 17, 19, 23, 29, 34, 45, 69, 70, 73, 106, 136, 139, 141, 143
 nipple drinkers 17, 29, 45, 69, 106, 151
 nipples 17, 18, 19, 21, 34, 69, 79, 109, 136, 139, 141, 143
 nitrates 70, 74
 nutrition 13, 32, 54, 104, 138

O

open sided 20, 55, 56, 65, 66, 67
 oval feeder 35, 106, 142

P

pan feeder 35, 106, 142
 parasite 3, 9, 11, 152
 pathogen 4
 peak production 31, 33, 40, 44, 47, 54, 55, 56, 57, 58, 59, 60, 61, 62, 65, 68, 77, 80, 91, 97, 100, 101, 140, 142, 144
 pelvic fat 43, 44, 51, 53, 64, 67, 68, 138, 139
 perimeter inlets 65, 117, 119, 120
 pH 71, 74, 111, 112, 127
 photo stimulation 23, 31, 32, 33, 38, 42, 43, 44, 53, 54, 55, 58, 62, 63, 64, 66, 67, 68, 81, 92, 100, 106, 136, 138, 142
 placement 3, 5, 12, 13, 14, 16, 17, 18, 19, 20, 21, 23, 24, 25, 27, 29, 34, 35, 37, 70, 77, 84, 108, 117, 126, 138
 pressure 17, 29, 34, 43, 63, 69, 70, 72, 82, 87, 109, 110, 114, 117, 119, 120, 121, 123, 124, 129, 130, 132, 133
 production 1, 4, 7, 20, 22, 26, 30, 31, 32, 33, 36, 37, 39, 40, 43, 44, 45, 46, 47, 49, 51, 52, 53, 54, 55, 56, 57, 58, 59, 60, 61, 62, 63, 64, 65, 66, 67, 68, 69, 72, 75, 77, 80, 81, 87, 88, 89, 90, 91, 92, 94, 95, 96, 97, 99, 100, 101, 106, 107, 108, 121, 124, 125, 126, 136, 137, 138, 139, 140, 141, 142, 143, 144, 145
 production house 22, 51, 52, 69, 87, 88, 91, 107, 121, 125, 126, 137

R

rearing 11, 13, 19, 20, 22, 23, 28, 30, 31, 32, 34, 36, 37, 38, 39, 40, 42, 49, 51, 52, 59, 60, 62, 63, 65, 66, 67, 69, 70, 75, 82, 83, 85, 86, 88, 91, 94, 106, 107, 121, 123, 132, 133, 136, 137, 138, 139, 144
 records 51, 96, 105
 rodent 3, 7, 108, 113, 152

S

sanitation 4, 8, 9, 72, 73, 74, 108, 113, 145
 scales 3, 9, 17, 18, 75, 76, 77, 83, 84, 85, 138
 scratch area 45, 46, 47, 49, 51, 88, 107, 126, 144
 scratch feed 40, 58,
 sexing error 52
 slat height 46,
 slats 9, 18, 22, 45, 46, 47, 49, 50, 51, 77, 87, 88, 94, 106, 107, 108, 109, 110, 124, 126, 137, 140, 144

slow feather 33, 52, 60, 62, 67,
 sorting 82, 83, 84, 85, 139
 spiking 54, 87, 89, 93, 94, 95, 136, 141
 standard deviation 78, 84, 148,
 starter 24, 32, 33,
 sterilize 73, 113
 stir fan 115
 stocking 19, 20, 28, 47, 49, 79, 127, 136, 140
 stocking density 19, 20, 28, 33, 38, 40, 47, 48, 49, 50, 84, 86, 145
 supplemental 14, 21, 29
 synchronization 20, 44, 51, 87, 88, 137, 140

T

toes 29, 52, 86
 total dissolved solids 72
 transfer 51, 95
 transition ventilation 121, 122
 trough 58, 91, 140
 tunnel fans 65, 124, 127, 133
 tunnel ventilation 49, 50, 121, 123, 124, 125, 126

U

uniformity 15, 16, 20, 23, 27, 28, 30, 32, 33, 34, 37, 38, 40, 42, 43, 44, 51, 52, 54, 60, 62, 64, 65, 68, 75, 77, 79, 82, 83, 84, 85, 86, 87, 106, 121, 126, 136, 138, 139, 142, 143, 145

V

vaccination 2, 3, 5, 6, 12, 23, 28, 39, 51, 73
 ventilation 14, 18, 20, 21, 22, 45, 46, 49, 50, 65, 67, 79, 106, 110, 114, 116, 117, 118, 119, 120, 121, 122, 123, 124, 125, 126, 127, 132, 137, 139, 141, 143, 144

W

water 3, 3, 6, 15, 17, 18, 28, 29, 34, 69, 70, 72, 73, 96, 109, 129, 130, 131, 137, 139,
141, 143, 149

weighing 3, 17, 18, 23, 30, 37, 58, 60, 62, 70, 76, 77, 82, 83, 85, 100, 101, 136, 138,
139, 140, 142

welfare 1, 2, 5, 14, 17, 20, 22, 23, 24, 25, 26, 28, 31, 38, 39, 42, 44, 46, 52, 53, 84,
87, 95, 108, 114, 116

worms 11, 94



www.cobb-vantress.com

L-009-01-20 EN