

SUPER NICK

Parent Stock
Layer Breeder



INTERNATIONAL

The key to your profit!



NEW
Management
Guide



The key to your profit!

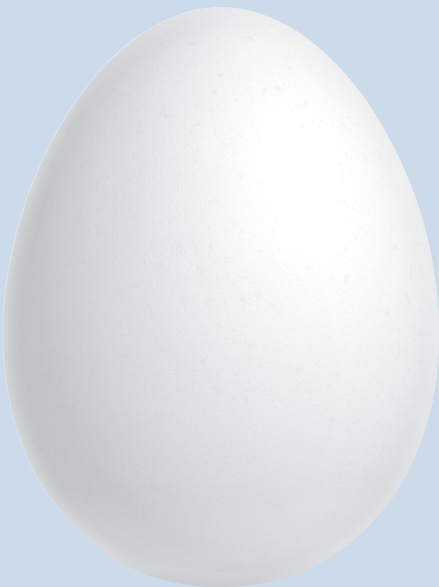

The geneticists and research staff at H&N have worked for many years to produce a layer with an excellent performance. This was achieved by a balanced selection procedure, taking many traits into account, such as egg production rate, livability, feed efficiency and internal and external egg quality. These traits are the major factors that determine the profitability for an egg producer.

The goal now is to enable H&N Parent Stock flocks to express their full genetic potential by providing the feed, management and environment they need to obtain optimum performance. This manual outlines management practices that experience has proven to be important and will help producers with recommendations to achieve the best results. Good poultry management is the key to success with H&N breeders.

Good bird management sometimes requires a little extra effort, but this hard work will certainly be repaid. It is not complicated; it simply requires paying attention to the details on the farm and the behavior of the birds, common sense and proper decision-making throughout the lifetime of the flock. The H&N service team worked hard to create this manual as a very detailed guideline, however the success of the breeder flocks still depends on you and your stockmanship skills.

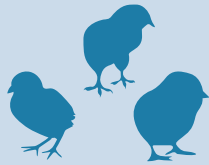

HATCHABILITY

Total hatch, peak

90 %

Total hatch, average

83 %

Hatch of saleable pullets, peak

44 %

Hatch of saleable pullets, average

41 %

Saleable pullets per Hen-Housed

21 – 75 weeks 122

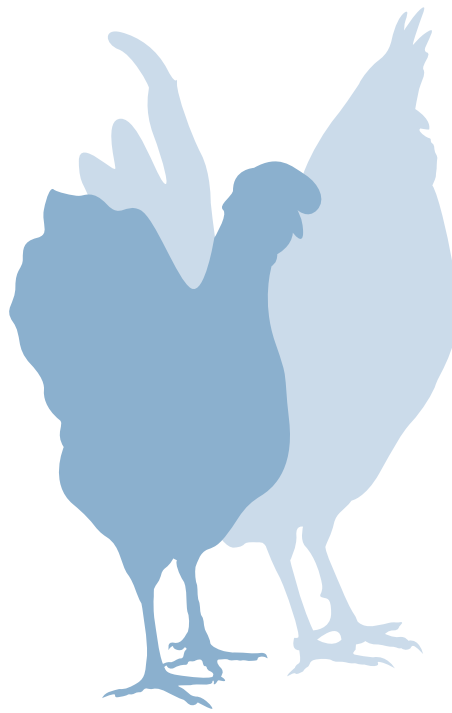

SUMMARY OF SUPER NICK PERFORMANCE STANDARDS



EGG PRODUCTION TO 75 WEEKS

Total eggs per Hen-Housed

328

Hatching eggs per Hen-Housed

298

Age at 50 % production

145 – 155 days



LIVEABILITY

Growing cycle

0 – 20 weeks 96 – 98 %

Production cycle

21 – 75 weeks 88 – 92 %



BODY WEIGHT

Age (weeks)	Female (g)	Male (g)
20	1360	1720
40	1650	2240
75	1700	2310



FEED CONSUMPTION

Males & Females

Growing cycle

0 – 20 weeks 7.3 – 7.5 kg

Production cycle

21 – 75 weeks 42 – 45 kg



CONTENT

6 HOUSING SYSTEMS

- 6 Rearing house systems for layer breeder
- 7 Production house systems for layer breeder
- 8 Floor house with automatic equipment
- 8 Family cages for layer breeder
- 10 Stockmanship skills

11 HOUSE PREPARATION AND ARRIVAL OF CHICKS

- 11 Cleaning and disinfection procedure
- 12 Stocking density
- 13 Floor rearing house preparation
- 14 Cage rearing preparation (cage rearing systems)
- 15 Pre-heating the rearing house
- 16 Arrival of the chicks

18 BROODING (1– 21 DAYS)

- 18 Brooding lighting program
- 20 What do chicks need during the first week?
 - Temperature
 - Water
 - Feed
 - Light
 - Humidity
 - Ventilation
- 21 How do you know that everything is running smoothly?
 - Crop fill measurement
 - Cloacal temperature
 - Behavior
 - Body weight
 - 7-day mortality

24 GROWING (3 – 9 WEEKS)

- 24 Light program
 - Design your light program in five steps
- 27 Pullet development

28 Feed intake

29 Feathering

30 Perches

31 REARING PERIOD (9 – 15 WEEKS)

- 31 Body weight
- 32 Feed intake training
- 32 Sexing errors

33 TRANSFER (15 – 18 WEEKS)

- 33 Preparing the breeding flock to move to the laying house
- 33 Stocking density in the laying house
- 34 Transport preparation
- 35 Housing in the laying house

37 ONSET OF PRODUCTION (18 – 22 WEEKS)

- 37 Period after transfer
- 38 Light and light programs
- 39 Management until the production peak
- 40 Nest management
- 41 Males management
- 44 Onset of lay

45 PRODUCTION PERIOD (22 – 75 WEEKS)

- 45 Production stage
- 45 Production monitoring
- 46 Troubleshooting
- 47 Feather covering
- 47 Aggression
- 48 Feeding layers during production
- 48 Midnight lighting
- 49 Laying process

CONTENT

36 HATCHING EGG MANAGEMENT

- Egg weight
 - Egg selection
 - Egg disinfection
 - Nest management
 - Egg collection
 - Egg storage
 - Transportation
 - Hatchery
- 52 Hairlines cracked eggs
- 52 Examples of unsettable eggs

53 NUTRITION

- 53 Rearing Nutrition
- Feed description and management
 - Formulation tips
 - Nutrient requirements
- 56 Onset of lay nutrition
- Feed description and management
 - Nutrient requirements
 - Formulation tips
- 57 Laying nutrition
- Feed description and management
 - Nutrient requirements
 - Formulation tips
- 63 Feed structure
- 63 Feed quality

64 HOUSE ENVIRONMENT

- 64 Hen thermo-regulation
- 65 Temperature
- 66 Hot climate
- 67 Water quality
- 68 Air quality
- 68 Ventilation systems for layer breeder
- 69 Light

70 BIRD ASSESSMENT

- 70 Pullet phase
- Body weight and uniformity
 - Mortality
 - Shank length or keel length
- 71 Production phase
- Male evaluation
 - Body weight and uniformity
 - Mortality
 - Efficiency parameters
 - Egg production

73 HEALTH AND BIOSECURITY

- 70 Flock health at parent stock farms:
a critical point for success
- 74 Biosecurity program
- 74 Biosecurity types
- Conceptual biosecurity
 - Structural biosecurity
 - Operational biosecurity
- 75 Biosecurity program in seven steps
- 79 Vaccination programs
- 80 Administering vaccines in practice
- 81 Monitoring program
- 82 Breeding scheme
- 83 Comprehensive breeding goals

84 PERFORMANCE GOALS

- 84 Performance of the H&N Super Nick PS
to 75 weeks of age



HOUSING SYSTEMS

- ▶ Review Housing system suitable for Parent stock.
- ▶ How to house one-day-old chicks.

Several housing systems are available for layers parent stock rearing & production. It is possible to achieve a good productivity in all of them but each one has its advantages and disadvantage. It should be considered that layer parent stock need from adapted equipment. A common finding is to observe flock kept in houses that fulfill the require-

ment for other types of birds (as broiler breeder or commercial layer) but not those of layer parent stock flocks. This is not an optimal situation.

No matter what the housing system is, a key point for success is to respect the stocking density. This as relevant as in commercial layer's production system, but it is even more

important as mating and other social behaviors are key for getting the full reproductive potential from the birds

Finally, Biosecurity should be one of the main driver for housing parent stock flocks as it is not only important to produce chicks but healthy chicks.

REARING HOUSING SYSTEMS FOR LAYER BREEDER

FLOOR HOUSING



- ▶ Flocks coming from this rearing system can be transferred into floor, family cage or individual cage in production.

Most of PS flock are reared in this type of facilities. Basic equipment includes drinkers, feeders, heaters, perches and first-age equipment.

Some special consideration about the equipment should be taken:

- **Drinkers:** If you are going to move the flock to a production house equipped with nipples drinkers, then rearing house should be also equipped with nipples drinkers
- **Perches:** Birds should have access to perches by 3 weeks of age. Provide 15 cm perch space per bird. It will encourage bird to learn to jump and move in different tiers. It should not be placed over the drinker line.
- **Feeders** should be adapted to fully combed males.
- **Compartments:** with equally number of breeders.

CAGE HOUSING



- ▶ Flocks coming from this rearing system can be transferred into family cage or individual cage in production.

Some special consideration about the equipment should be taken:

- **Males cages:** It should be enough height to allow its fully development. If all the cages meet this characteristic, then males and females can be housed together. If not, house males in males-adapted cage.
- **Feeders** should be adapted to fully combed males. Otherwise, males must be dubbed at hatchery.

AVIARY HOUSING

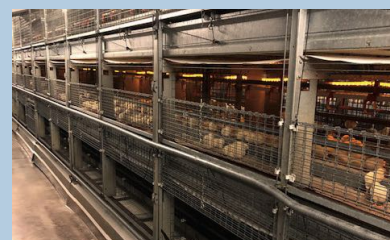

- ▶ Flocks coming from this rearing system can be transferred into block type aviaries also to floor, family cages or individual cage in production.

Some considerations:

- When housing males with intact combs, there must be enough space between feed chain and perches on top of feeders to give them adequate space to eat.
- Enough space between perches on top of feeders and roof of cage to prevent comb's injuries.
- Best to make compartments with equally number of breeders.
- The aisle between blocks must be > 1.8 m wide.
- Feeders should be adapted to fully combed males. Otherwise, males must be dubbed at hatchery.

PRODUCTION HOUSING SYSTEMS FOR LAYER BREEDER

FLOOR SYSTEM



- ▶ Most used housing system all around for layer parent stock.
- Birds are housed in barn and have access to nest for laying.
- Only one feeding system is needed for, both, males and females.
- Normally manure is stored during all the flock and removed after flock depopulation.
- Slatted area is present in most of layout.
- It should be equipped with perches.
- Matting occurs naturally.
- Good option is divide the house in compartments with equally number of breeders.

INDIVIDUAL CAGE



- ▶ Normally not used in layer parent stock but in selection farms. Still it is an option when labor cost is low and facilities are affordable.
- Males are housed in male-adapted individual cages, females in female-adapted cage.
- Manure can be collected by a belt in most of models.
- Automatic feeding in most of models
- No natural matting. Artificial insemination (AI) is required

AVIARY SYSTEM*



- ▶ Fast growing type of cage-free systems for commercial layers, but also for PS with very good results.
- For use of this production systems the layer parent stock need an aviary rearing system from 0–17 weeks of age.
- Only one feeding system is needed for males and females.
- Height of different levels need to be enough high for mating.
- Most manure can be collected by manure belt during production cycle.
- Matting occurs naturally.
- Birds need to be reared in aviary block system or floor with winchable elements system.
- When housing males with intact combs, there must be enough space between feed chain and perches on top of feeders to give them adequate space to eat.
- Enough space between perches on top of feeders and roof of cage to prevent comb's injuries.
- Best to make compartments with equally number of breeders.
- The aisle between blocks must be > 1.8 m wide.

FAMILY CAGE SYSTEM



- ▶ Very convenient system if labor or constructed square meter cost are high.
- Birds are housed in cage by groups of males & females.
- Feeder are used equally for males and females. Males grid areas prevent comb injuries during males feeding.
- Egg are laid in the wire and collected in egg belt. Some model includes nests.
- Manure can be collected during the production cycle by the manure belt.
- Recommended more than 90 birds per cage.
- Matting occur naturally.
- It is highly recommended to included perches inside the cages.

*For more information about Aviary System please ask your technical service representative.

	Floor System	Aviary System	Family Cage System	Individual Cage
Initial equipment investment	+	+/-	-	-
Bird per house square meter	+/-	+	+	+
Fertility	+++	+++	++	++*
Dirty eggs	+/-	+/-	++	++
Males use	++	++	+	+++
Labor cost	+	+	++	++
Manure controle	+/-	+	+	+
Animal welfare friendly	++	++	+	--

*If AI correctly performed



FLOOR HOUSE WITH AUTOMATIC EQUIPMENT

PERCHES



Perches are a key equipment to maintain good litter conditions and control floor eggs. Also, it helps to enhance the behavior expression and to reduce social stress. Round or rectangular design is preferred for perches. In any case, it should support bottom of foot and allow the bird to close the claw on it.

DRINKERS



Two main options are used:

Nipples waterers: Most used system in layers. Some consideration should be taken:

- Water pressure regulators are highly recommended.
- Most used nipples have water flow up to 70 cc/minute in rearing and up to 130 cc/minute in production. However, it's fundamental to follow the manufacturer recommendations because every brand is managed differently.
- System should be prepared for be flushed

Bell waterers: Also, a good option. It is preferred if the water intake is supposed to be very high (Ex. hot weathers areas).

NEST



It should meet some characteristics:

- Be dark, quiet, warm, and free of air flow.
- Nest temperature should be in the hens comfort zone.
- It should be possible to close it during the night.
- Nest floor should provide comfort for nesting, have a soften effect on the egg during the lay and allow egg to roll easily to egg belt
- Easy to clean, inspect and disinfect during the production period.

SLAT



A slatted area is commonly used in floor system houses. The main aim of this area is to increase the manure storage capacity and to keep the nest clean. Some point should be considered for avoid eggs on the floor and slats:

- Slatted area should cover at least 60 % of the total room. A 100 % slatted area is a good option while 30 % slatted area is wrong layout for layers.
- Feed and water lines should be installed in good height on the slatted area (avoid having them on the scratch zone). It should not block movement of females to nest.

FEEDERS



Only one system for males and females should be installed. Same type in rearing and production. Feed balance and daily hoppers are not needed as birds should be fed ad libitum. Two main options are mostly used:



Chain feeder: Easy-to-use and repair. For a smoother feed distribution, fast chain (> 18m/min) are preferred. No male grill is needed.

Pan feeder: Easy transition. No male's grilles should be used. Feeding window should allow both males and females to have access to the feed.

FAMILY CAGES FOR LAYER BREEDER

CAGE



The cage should be big enough to house at least 90 birds with a stocking density of at least 650 cm² / bird. This will help to keep a good fertility throughout the production cycle.

FLOOR



Plastic slat

There are two types of materials: wire or plastic. The floor should be suitable to avoid leg and foot problems (especially in males). Excellent for mating and to prevent broken eggs. The size of the floor mesh must be around 2.54 x 2.54 cm and capable to resist the weight of females and males all together.

PERCHES



The cages must have perches to improve the bird's behavior (roosting). Should be rounded, and the birds must be able to easily keep balance and capable to close the claws on it.

FEEDERS



- Must follow the feeder space recommendations, which is one of the key component to have a good flock uniformity and body weight and is critical in family cages. The feeder space should not be blocked by the nest or any other structure.
- In case of fully combed males, the cage must have a feeder space with special grill for them.
- **Chain feeder:** Easy-to-use & repair. For a smoother feed distribution, fast chain (>18m/ min) are preferred.
- Be aware of feed trough that go inside the cages. Some models have a grill that could make it hard for the males to eat.

DRINKERS



- Nipples drinkers:** Best system for cages. Some consideration should be taken:
- The nipple drinkers should have a drip-catcher cup to prevent water on the manure belt.
 - Water pressure regulators are highly recommended.
 - Most used nipples have water a flow up to 70 cc/ minute in rearing and up to 130 cc/minute in production. However, it's fundamental to follow the manufacturer recommendations because every brand is managed differently.
 - System should be prepared to be flushed.

NESTS



- There are different types of family cages:
- without nest
 - with curtained area.
 - with a real nest (group nest)
- The nests shouldn't be blocking the feeders. Keep an eye on overcrowd of eggs in the nests. Important to follow the nesting space recommendations.



HOUSING SYSTEMS

STOCKMANSHIP SKILLS

There is a key component on the success of a poultry operation, which is the human element. The stockmanship skills are critical to get the best from the genetic and transform it into excellent performance and profit. The skills are: **sight** (look at bird's behavior), smell (air quality), **taste** (water and feed), hearing (birds sound), and **feel** (environmental temperature, crop fill, etc).

Along with the skills is very important to have the tools to help us get the more accurate information to take the best decisions and make corrections. Therefore, a tool box is a necessity.

It is very important to have the right tools to assess and evaluate the environmental and bird's conditions at arrival, for the first seven days and during the whole production cycle.

We recommend a list of tools that every poultry person should have:

- **Infrared thermometer for environmental temperature**
- **Infrared thermometer for vent temperature**
- **Scale to weigh day old chicks**
- **Scale to weigh pullets**
- **Lux meter to measure light intensity**

YOUR TOOLBOX



HOUSE PREPARATION AND ARRIVAL OF CHICKS

- ▶ How to prepare the house before the one-day-old chicks arrive.
- ▶ How to house one-day-old chicks.

CLEANING AND DISINFECTION PROCEDURE

STEP 1

Preparation

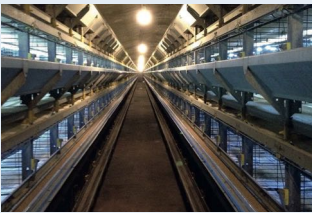

It is essential to remove all equipment or waste (dead birds, feed, eggs, manure, etc.) left in the house before cleaning. Any removable material/equipment should be detached.

STEP 2

Dry Cleaning



This removes all dust and dry organic material from the house using compressed air, brooms or shovels.

STEP 3

Wet Cleaning



This removes all remaining organic material and grease. Thoroughly clean using detergent and hot water. Apply foam detergent and leave it to work for the specified time.

STEP 4

Disinfection



This kills all remaining pathogens that survived the previous steps. For good performance:

- Use only reliable and effective disinfectants
- Apply the appropriate dose
- Respect contact time and temperature
- Take extra care to clean litter area in floor/aviary systems to prevent coccidiosis/worms.
- In new litter, apply a product to kill mold.

STEP 5

Fumigation



- Fumigate after liquid disinfection has been completed and the equipment has been installed again.
- Follow the label instructions.
- Use appropriate PPE (personal protective equipment).

STEP 6

Sampling

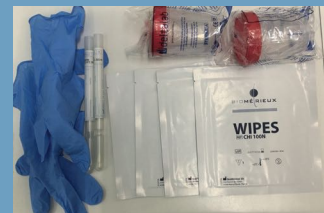

Sample after cleaning and disinfection, check if the microbiological results are ok. Corresponding sampling and laboratory analysis should be performed: at least eight samples per house should be taken, distributed randomly as shown in table 1. If results are unacceptable, take corrective measures.



HOUSE PREPARATION AND ARRIVAL OF CHICKS

Cleaning and disinfection procedures are key to preventing pathogens from passing from one flock to the next. They also prevent pathogens from challenging birds in their early life. The goal of this procedure is to minimize all microorganisms in the house to offer chicks the best opportunity to perform well.

Table 1: Clean and disinfection microbiological results

Place of sampling	Salmonella spp.	Enterobacteria in 16 sq cm	
	Unacceptable	Good	Unacceptable
Wall-floor junction Drinkers Feeders Manure bell Eggs belt Fans	Presence	< 5	> 10

IMPORTANT

1. Do not proceed to the next step until the previous step has been completed.
2. Clean the area outside the house, storage and service areas, water lines and ventilation system.
3. Provide staff with adequate protection and clothing: masks, gloves, etc.
4. Maintain the cleaning equipment regularly.

STOCKING DENSITY

An adequate stocking density is a condition for success in rearing chicks. A high stocking density impacts negatively on daily growth, flock uniformity and chick development.

Furthermore, a high stocking density combined with reduced feeder space will limit feed consumption, which might already be low under certain conditions (e.g. hot

climate or poor feed quality,) and sufficient access to water.

Table 2: Stocking density in rearing farms

Age	Floor space ^{1 2 3}		Feeder space ^{2 3 4}		Drinker Space ^{2 3}	
	Cage	Floor	Cage	Floor	Cage	Floor
0 – 3 weeks	200 cm ² /bird	> 21 birds/m ²	2.5 cm/bird	4 cm/bird 60 birds/pan (ø 40 cm)	1.25 trough cm/bird 16 birds/nipple	1.4 trough cm/bird 16 birds/nipple 100 birds/fountain
3 – 16 weeks	400 cm ² /bird	> 16 birds/m ²	5 cm/bird	8 cm/bird 30 birds/pan (ø 40 cm)	2.5 trough cm/bird 8 birds/nipple	2.5 trough cm/bird 8 birds/nipple 75 birds/fountain

¹ Floor space: include all living space: litter area and extra levels (slats or tiers).

² Spaces can be different in each country due to regulations from government, animal welfare organizations and retailers.

³ All these values are the minimal recommendation. Provide more space in hot climate areas.

⁴ Pan feeders: 2 cm / bird 0–3 weeks and 4 cm / bird 3–16 weeks (diameter = 3.14 x circumference)

FLOOR REARING HOUSE PREPARATION

There are mainly two types of floor brooding: whole house brooding or spot brooding. The one best for your system will depend on the equipment: heaters, drinkers and feeders.



Whole house brooding



Spot brooding

Feeding system

Supplemental feeder trays should be provided within the brooder ring for a few days (7 to 10) days, until all chicks are eating from the regular feeding system. Ensure adequate feeder space is provided.

Cover at least 50 % of the brooding area with paper and scatter feed over the paper. Use extra feeders (paper trays) in a ratio of 80 to 100 chicks per extra feeder.



Drinking system

Chicks must have unlimited access to clean, good quality, fresh water (20–25 °C). During the first days, cups or nipples should be checked and triggered several times per day to stimulate the chicks to drink. Supply additional drinkers which can be easily accessed until the chicks are drinking from the regular water system. Use extra bell drinkers at a ratio of 100/extra drinker (4 liters capacity).



Ventilation

Guarantee enough fresh air, but no drafts. In conventional pancake brooders, use chick guards (i.e. new cardboard) to prevent drafts. Start with a diameter of approx. 2 m in cool weather and approx. 4 m in hot weather. Enlarge the ring every couple of days and remove by six or seven days of age.

Light intensity

Provide both, optimal light intensity (40 to 60 lux) and uniform distribution (no shady areas). More details in the lighting chapter.



Distribute litter and paper

Only use new and clean litter. Insoluble grit should be fed if the chicks are on a type of litter (e.g. shavings) that will be eaten by the chicks.

Keep litter level low to prevent bad air quality (Ammonia) in later period of rearing.



Example of a correct set-up for placement



HOUSE PREPARATION AND ARRIVAL OF CHICKS

CAGE REARING PREPARATION (CAGE REARING SYSTEMS)

Distribution

Birds are housed at a higher stocking density during the first weeks. To ensure uniform pullet growth, it is important that the birds are moved into the empty cages at the appropriate time and with the correct cage density.

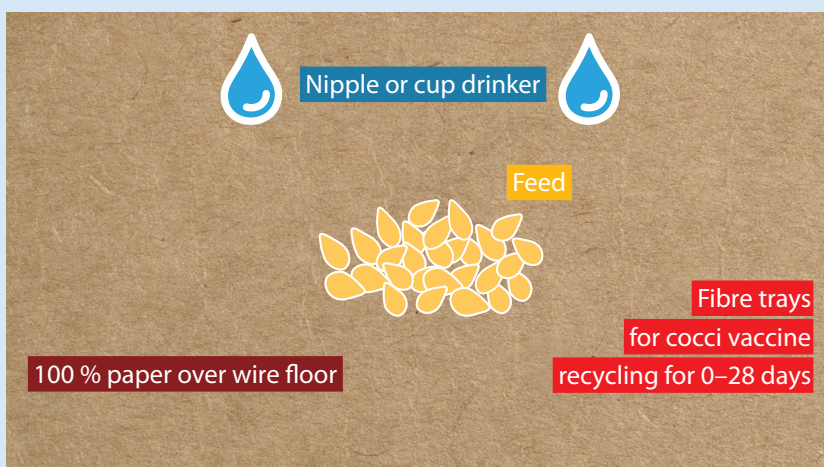

Paper

Cage wires should be covered with paper during the first week of life. Avoid covering the area directly under the drinking system, but cover the surrounding area. When drinkers have a drip cup, you can put paper underneath them (see image). Keep the paper until 18 to 21 days of age. If Coccidia vaccine was applied, ask your veterinarian or H&N technical team for advice.

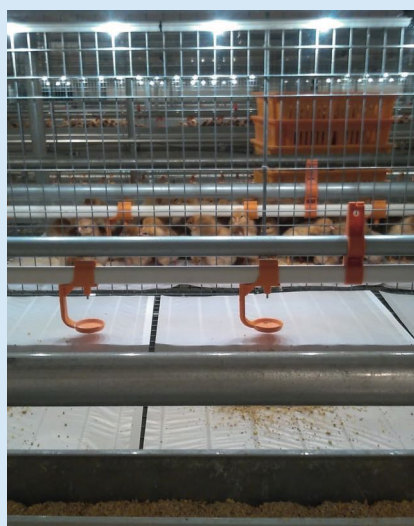

Drinking system

360°-activated nipples in the brooding cages are preferred. If unavailable, provide cup drinkers during the first week (30 to 40 chicks per drinker) Reduce the water pressure on the nipples to make triggering the nipples easier and attract the chicks by the drop formation. **Take extra care when infrared beak treatment was applied at the hatchery!**



360°-Nipples (low pressure)

Feeding system

Abundant feed should be provided in the feeders and additionally on the papers inside the cages before the chicks are housed to stimulate feed intake.

Light intensity

Provide both, optimal light intensity (40 to 60 lux) and uniform distribution (no shady areas). More details in the lighting chapter.



Feed on paper & optimal light intensity

PRE-HEATING THE REARING HOUSE

Pre-heat the house before the chicks arrive: 24 hours in warm weather and 48 hours in cold weather.

Do not only heat the air, but also litter, soil and equipment. Chicks gain and lose temperature easily through conduction.

When you don't preheat the house to an optimal level you could experiment chick mortality and bad development impacting on immune and digestive systems.

Temperature recommendation

Soil/Concrete: 28 °C Litter: 30 °C Air: 34 °C

Humidity recommendation

60 to 70 %



Air

34 – 36 °C / 93.2 – 96.8 °F



Floor / Concrete

≥ 28 °C / ≥ 82.4 °F



Litter

≥ 32 °C / ≥ 89.6 °F

CHECK LIST BEFORE CHICKS ARRIVE

1. Ensure a uniform temperature inside the house. Check the temperature in different areas (use an infrared thermometer). Check that temperature and humidity sensors are working properly.
2. Check the time clock settings and light dimmer settings.
3. Check automatic water and feed systems for correct settings and uniform distribution.
4. Flush water lines before arrival.
5. Trigger nipples and cups to ensure proper working condition and to stimulate the chicks to drink.
6. Coordinate time of arrival with the hatchery and confirm the number and condition of the delivered chicks.

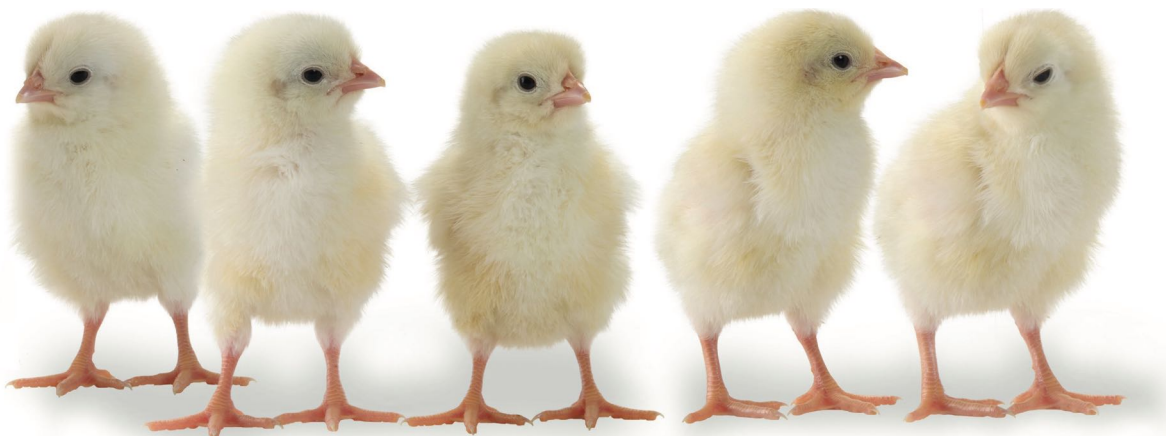



HOUSE PREPARATION AND ARRIVAL OF CHICKS

ARRIVAL OF THE CHICKS

Airport

Chicks arrive to the destination airport after a long journey. Thus, the sooner they are liberated for the border authorities, the better will arrive to the farm. Keep in mind that a copy of all the chick's documentation is always sent in the back of the white box included in the delivery

In the meantime, Chick crates / pallets never should be stored in conditions that are too

hot or cold, windy, under the rain or in direct sunlight.

If crates are clearly damaged or if you observe dead birds when the flock is delivered to you, an official claim should be completed before departing from the airport. You will find the official form in the back of the white box. H&N logistic team can support you in that case.



White Chick Box: Cargo Damage

Transport to the farm

To transport the flock in environment controlled truck should avoid unnecessary risk during the journey. In any case, place stacks giving them space between chick crates for air flow. Truck must be clean and disinfected correctly before of this service. Keep monitoring temperature (24 to 26 °C) , relative humidity and chick's behavior.



Truck must be cleaned and disinfected



Bevor arrival: Check the conditions upon arrival

Unloading the chicks

Place the birds gently but quickly into the house and provide immediate access to water and feed. Crates should be taken into the farm and distributed as soon as possible.

With floor brooding, place the chicks directly over the paper and feed. With cage and row aviary brooding, place the right number of chicks in each cage. Males and females are preferred to be housed together from day 1.

It is important to check the mortality, body weight, internal temperature from the just arrived chicks. These data should be recorded into the FSP program. If you have any doubt about how to get correctly these data, get in contact with you H&N technical service staff. It is important to check during arrival the delivery note to confirm if the bird's numbers, the vaccine applied at the hatchery or the special treatment are those that were demanded. Corrective measures are easy to take during the first day but misunderstanding error can be catastrophic afterwards.



Quick unload from the truck of all chick's boxes



Check chicks condition upon arrival



Fast distribution and unload of chick boxes in the pens



Always weigh chicks at arrival

Observe chick's behavior right after placement



Chicks should be active,
moving around,
eating and drinking.

KEY POINTS

- ▶ A good and clear communication with H&N logistic team is a key component. They will answer and solve any doubts.
- ▶ Ensure the house has been cleaned and disinfected correctly before chicks arrive.
- ▶ Preheat the house to the correct temperature: Always test at chick level brooding period.
- ▶ Observe stocking density recommendations and adapt drinking and feeding systems to the brooding period.
- ▶ House the chicks quickly so they can access water and feed.
- ▶ Take the time to inspect the chicks for body temperature and quality.



BROODING (1 – 21 DAYS)

- ▶ How to maximize male and female liveability during the first week of life.
- ▶ How to promote growth and development of key organs during the first three weeks of life.
- ▶ How to perform effective beak trimming without a detrimental effect on chick welfare.

BROODING LIGHTING PROGRAM

INTERMITTENT LIGHTING PROGRAM

(H&N Recommendation)

▶ Dark houses only (< 3 lux)

This program can be used for up to 7-10 days after arrival. Then switch back to the regular step-down lighting program. Using this lighting program has the following advantages:

- Chick behavior is synchronized; they rest or sleep at the same time.
- Weak chicks will be stimulated by stronger ones to move as well as to eat and drink.
- The behavior of the flock is more uniform and evaluating the flock is much easier.
- Chick mortality will decrease.

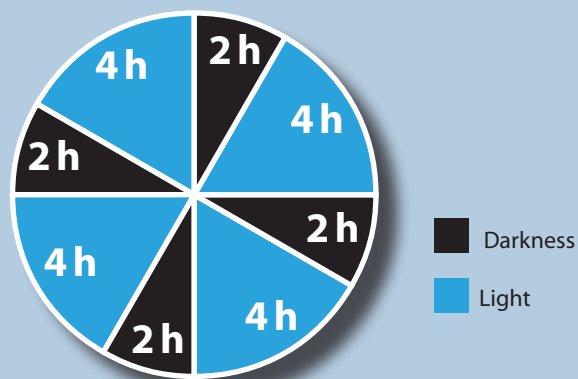

Intermittent lighting program

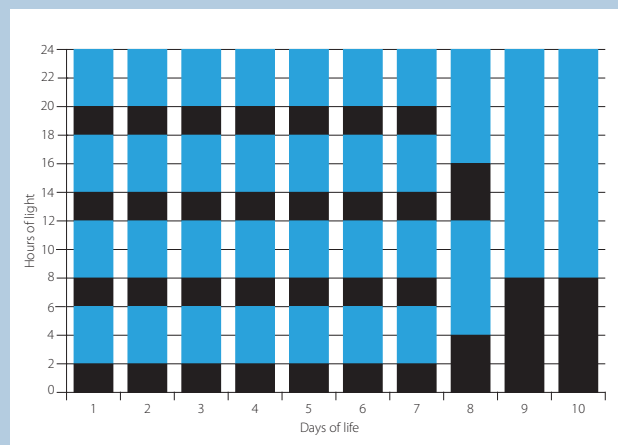

NON-INTERMITTENT LIGHTING PROGRAM

▶ All houses

In open houses is not easy to implement the intermittent lighting program. If this cannot be applied, 22-24 hours of light during the first 2-3 days is common practice. Providing this dark period to allow the chicks to rest is highly recommended.

In a dark house the light level should be lower than 3 lux when the light-proof system is set. In other words, it must be completely dark.

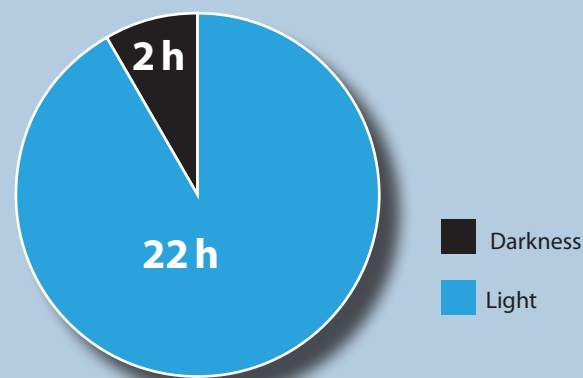

Non-intermittent lighting program

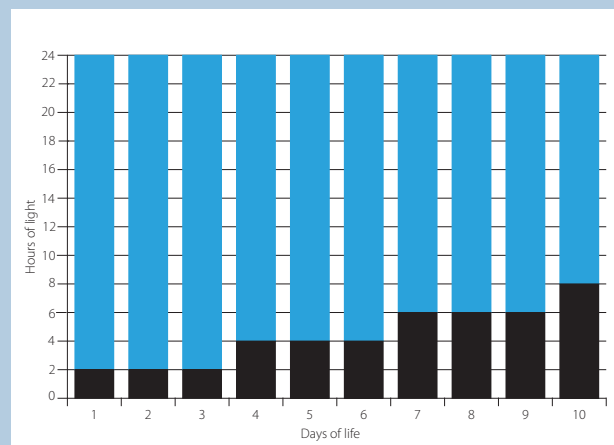

WHAT DO CHICKS NEED DURING THE FIRST WEEK?

► Remember that chicks born ectothermic can't control their body temperature therefore they need special care (specially temperature).



TEMPERATURE

The temperature should be between 34–36 °C for the first few days (see table).

- **Correct temperature:** Chicks will be well distributed and active.
- **Low temperature:** Chicks will group together and sound stressed.
- **High temperature:** Chicks will group in the coldest places, are inactive and pant.

Temperature recommendations:

- Cage air temperature: 34–35 °C
- Paper and/or litter temperature: > 32 °C
- Concrete/ground: > 28 °C

Pasted vents may indicate a too high or too low temperature.

The temperature management in **cage brooding is more critical than floor** because chicks can't look for warmer or cooler spots.

After two or three days, decrease the temperature by 0.5 °C every day. **Be aware that the best indicator is chick behavior and cloacal temperature.** Check the flock every time you change your settings. If the house temperature is not uniform, take corrective measures by changing heaters and ventilation parameters.

When housing the chicks, follow these recommendations:

- Place the smallest chicks in the hottest areas or cages.
- Place the youngest chicks in the hottest areas or cages (if the flock is arriving over several days).
- During the first 10 days avoid placing chicks in very hot spots (near the heaters) or in very cold spots.
- If most of the chicks are from a young flock (less than 27 weeks), increase the objective temperature 1 to 2 °C (1,8 to 3,6 °F).

- Place the males together with females in case of Brown Nick and white breeders when males are dubbed.
- In case of non-dubbed white males, keep them separate for the first 6–7 weeks or until you recognize the secondary sexual characteristics, and after culling all sexing errors.
- If males are from a young PS flock (less than 27 weeks) keep them separate for the first 5 weeks in the warmer place of the house (when necessary, add females to stimulate activity).
- Cages: is necessary to place only comb treated males.
- Leave the extra males separate in pen or cages.
- In countries where dubbing is not allowed, an option is to wing-band the white males.

Table 3: Temperature recommendation

Type of brooding	Temperature at chicks arrival	Temperature decrease
Cage/Row aviary system	34 – 35 °C / 93 – 95 °F	Reduce 3 °C/5 °F each week until supplementary heat is no longer needed.
Floor	35 – 36 °C / 95 – 97 °F	

Correct temperature distribution

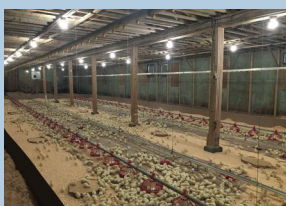
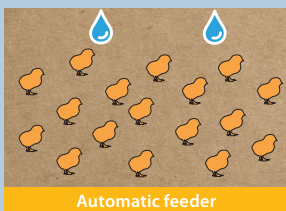

Low temperature distribution

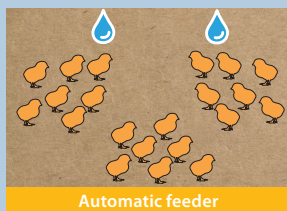

Hot temperature distribution

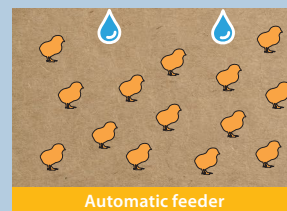



BROODING (1 – 21 DAYS)

WHAT DO CHICKS NEED DURING THE FIRST WEEK?

WATER



Set the height of the drinkers so the chicks can drink easily.

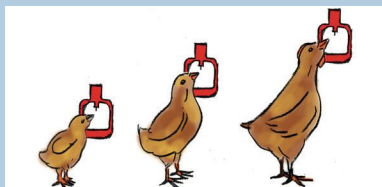

360-activated nipples drinkers

360-activated nipples are preferable in rearing houses. If not available, and especially with infrared beak treated chicks, we recommend using cups or other extra drinking system at a ratio of 80 to 100 birds per extra drinker. Especially important having extra drinkers when brooding on floor. Reduce the water pressure in the drinking

system to create a hanging drop at chick eye level. Follow manufacturer recommendations for flow rate.

Trigger the nipples or cups during the first 3–4 days to encourage chicks to drink. Important to keep all the time the water temperature between 20 to 25°C (68–77°F).

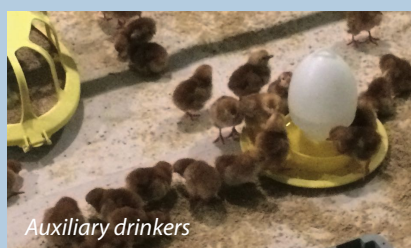

Auxiliary drinkers

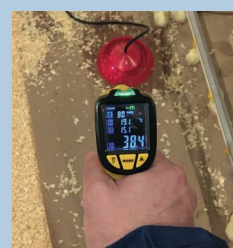

Always check the water temperature. In this case is too hot!

FEED



Good quality feed should be available for chicks immediately after placement. Feed should be scattered on the cage pa-



Feed on paper

per and renewed during the first 3–5 days. Place abundant feed in the feeders to attract the chicks.



Feed on trays

VENTILATION



Supply enough volume of fresh air to remove dust and undesirable gases. Ensure adequate air movement even on cold days.

Strong movements of air disturb the chicks, they will avoid using drafty areas. This can negatively impact on chick distribution and activity.

Adequate ventilation is especially important in hot weather.

LIGHT



The light intensity should be between 40–60 lux during the first week. This should be measured at drinker level.

Light should be spread uniformly throughout the entire cage or floor. It is important to avoid shady and dark areas in the brooding cage or floor area.

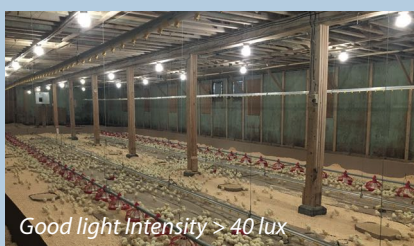

Good light Intensity > 40 lux

HUMIDITY



Humidity should be between 60 to 70 %. With lower than 40 % humidity, chicks may dehydrate, experience stress or damage their respiratory tract. Effects of higher than 80 % humidity could be wet litter, increase ammonia and poor air quality.

Adjust temperature according to relative humidity. For instance, the temperatures in this section are set for a humidity between 60–70 %. Above 80 % the comfortable temperature reduces by 1 °C (1.8 °F) and below 40 % increases by 1 °C (1.8 °F).

Draft incorrect

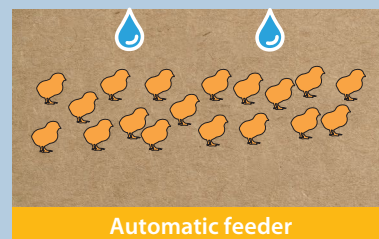

Automatic feeder

Draft



Grouped chicks

HOW DO YOU KNOW THAT EVERYTHING IS RUNNING SMOOTHLY?

CROP FILL MEASUREMENT

Crop fill measurement is a good tool to check if the chicks are eating in the first two days of life.

1: When is partial brooding, take 100 chicks randomly. Sample chicks distributed throughout the house for reliable readings. In case of spot brooding take 40 per circle. Cage and aviary Row systems brooding take a sample from the whole house (25 from the front, 50 from the middle and 25 from the back).

2: Gently feel the crop

3: The crop should be full, soft and rounded in started chicks

4. Check the result according to the time after placement

If the result is below target, check the brooding conditions and take corrective measures.

Correct crop filling

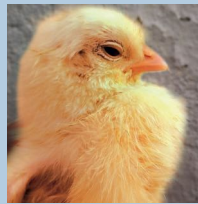

Incorrect crop filling



% of chicks with feed in the crop

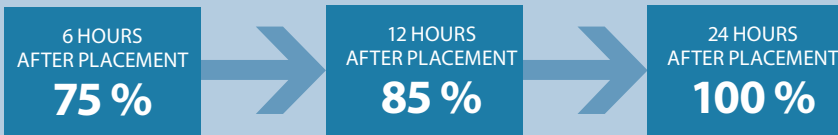

BEHAVIOR

PAY ATTENTION TO YOUR CHICKS!!!

Chicks cannot talk but they send you many signals:

- Check their distribution
- Check their activity
- Check the water and feed intake
- Check what kind of sound they are making
- Check if they look happy!!!

BODY WEIGHT

The body weight at the end of the first week must double the body weight at placement and uniformity must be > 80 %. In case, these goals are not achieved, a review of managements (drinking or feeding management, temperature, etc) and nutrition must be performed.

CLOACAL TEMPERATURE

Chick temperature is between 40–41 °C (104–106 after the moment of full homeothermy. During the first week of life chicks are unable to control their body temperature and it varies according to the ambient temperature. The cloacal temperature can be used to adjust house temperatures optimally.



1: Make sure you collect samples of chicks from different parts of the house. Samples chicks distributed throughout the house for reliable readings. Circle or spot brooding take temperature of 4–5 chicks per circle. In floor brooding a sample of 20 birds and cage brooding 50 (15 from the front, 20 from the middle and 15 from the back of the house).

2: Check their cloacal temperature.

3: Collect the information, calculate the average and adjust the house temperatures accordingly to achieve optimal chick temperatures. Adjust the environmental set point or temperature: + or – (0,5°C) (1°F) per 0,3°C (0,5°F) above the upper limit or below the lower limit of optimal vent temperature.

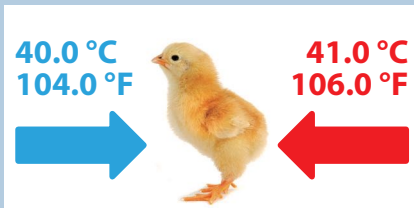

Important!

A chick's body temperature does not correlate with the current temperature but with the temperature of the last few hours.

7-DAY MORTALITY

The 7-day mortality must be below 3 %. If it is above this %, a complete review of managements must be done. It is important to have an excellent feed-back with the logistic and technical H&N team: good and bad things. Always perform necropsies of the mortality at arrival and in the first 7 days after placement.

A good brooding period is key for developing the gut, immune system and the skeleton. This period is therefore crucial to improve flock liveability during the first weeks, and to obtain good quality and productive pullets.



BROODING (1 – 21 DAYS)

BEAK TREATMENT

Beak treatment is one of the most important cannibalism/pecking prevention measures in poultry management, especially in open houses with high light intensity. While various methods of beak treatment may be used: the objective is to treat the beak in a uniform manner that will permanently

retard future beak growth. Improper beak treatment procedures may result in permanent damage to overall flock performance. Only perform beak treatment in females, don't do it in males. If you have questions about whether or not beak treat males please contact the technical service team.

Please remember that country-specific regulations should be observed.

Infrared beak treatment (IRBT) of day-old chicks

The beaks of day-old chicks can already be treated at the hatchery using infrared technology. This method can provide more uniform beak treatment provided it is performed by a machine and not by different crews.

The beak remains intact until 10–21 days and then the treated portion separates. Because of this process, chicks will need extra care during the brooding period.

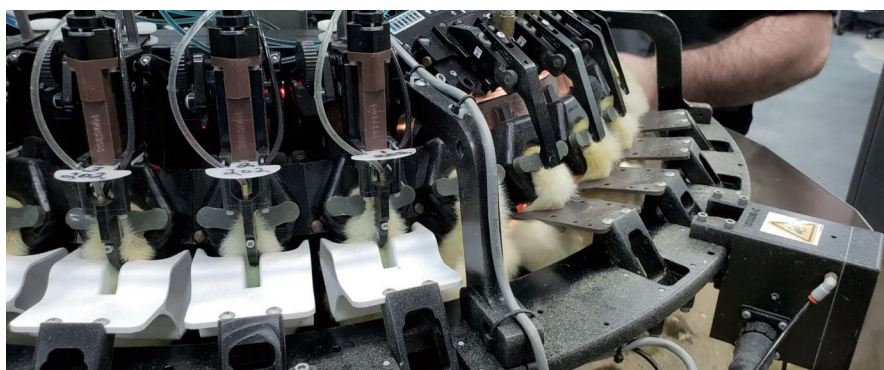

Pay attention to:

- **Drinking water:** It is vital to encourage the water intake in the first days. Preferably use 360-activated nipples as they are easy for chicks to use. Additional cup drinkers are also preferable. If bi-directional nipples are the only option, providing additional cup drinkers is obligatory.
- **Light:** Ensure the light level in the drinker area is 40–60 lux for 3 to 5 days
- **Feed:** Scatter feed on paper until day 7.
- Take extreme care when birds faced long journeys (more than 45 hours).

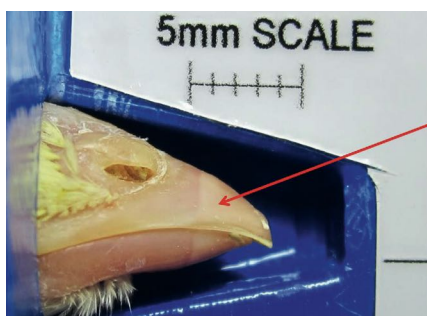

1 day old*



14 days old*

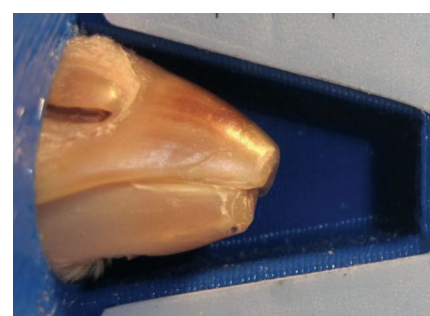

21 days old*



56 days old*



56 days old without beak treatment*

**Pictures courtesy of Novatech®
If you would like to have more information about this treatment please contact your regional Novatech® representative.*



7–10 day beak treatment

The conventional method of beak treatment is to treat the beaks with a hot blade.

Beak treatment should ideally be performed in the first 7–10 days. It is a delicate and precise manual procedure. Ensure these conditions are fulfilled before starting the process:

- **Healthy birds:** If birds are sick or in poor condition, treatment should be delayed until the flock has recovered. Beak treatment in an unhealthy flock can severely damage its viability.
- **Trained crew:** Due to the delicate and precise nature of this procedure, proper crew training is of the utmost importance. Only permit well-trained crews to perform this procedure. Never hurry up the crew especially if they are inexperienced.

- **Adapted equipment:** Hot blade machines are available on the market. For correct beak treatment, the blade temperature should be approximately 650 °C. The blade color may be used as an indicator. The use of a template with guide hole is recommended to make treatment easier and more uniform.
- Use a spreadsheet to review the quality of the beak treatment: beak length (too short/normal/too long), presence or not of blood, behavior of chicks after treatment, etc.
- In case of bleeding after treatment, a good measure is decrease the house temperature by 2 °C during the the procedure.



And the days after beak treatment ...

Special care should be provided to the chicks in the days following beak treatment:

- Monitor water intake. It should be reduced for 2 or 3 days but then the previous intake should be recovered. Reducing the water pressure in the nipple drinker lines could be useful and use of auxiliary cup or bell type waterer.
- Increase the house temperature until the chicks seem comfortable.
- Increase the feed level in the feeders.
- Add Vitamin K to the diet or drinking water a few days before and after beak treatment.

KEY POINTS

- ▶ Focus on water, feed, light intensity, air temperature and humidity during the first week.
- ▶ Check chick behavior to enable better settings of the brooding conditions.
- ▶ Implement an intermittent light program if possible.
- ▶ Perform beak treatment properly and apply special management care immediately after treatment.
- ▶ Measure and follow the cloacal temperature along with behavior to adjust temperature set point.



GROWING (3 – 9 WEEKS)

- ▶ How to set the correct light program in rearing according to your geographical situation, house type and production objectives.
- ▶ How to promote correct pullet growth during this period.
- ▶ How to use the chicks feathering and natural molting pattern to monitor chick development.
- ▶ How to use system and perches in floor/aviary rearing to promote bird welfare, liveability, body development and prevent floor eggs in the future.
- ▶ NEVER provide more space (feeder, drinker and stocking density) later than 3 weeks. The earlier the better.

LIGHT PROGRAM

BASIC PRINCIPLES

- The hours of light at the end of rearing should equal the hours of light at the production house before the start of light stimulation.
- The light intensity should be similar to what pullets will find in the production house.

DESIGN YOUR LIGHT PROGRAM IN FIVE STEPS

STEP 1

WHAT IS THE DESTINATION OF THE PULLETS?

- ▶ How many hours of light do you have in your country?

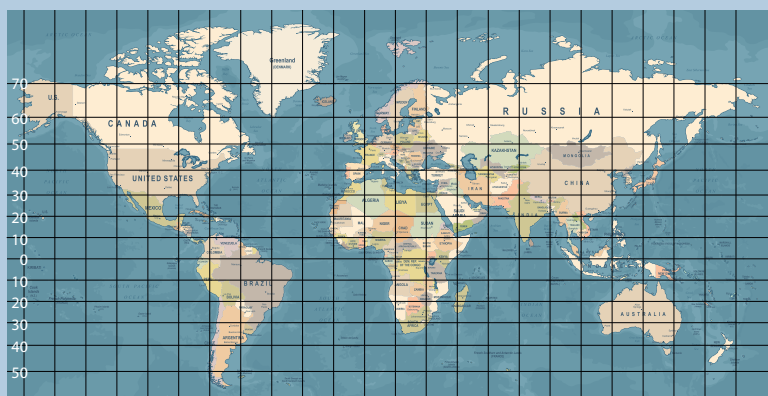

▶ Examples

Country	Hemisphere	Hatch date	Start of lay date	Light hours at start lay
Mexico	20° North	5 th February	June	12 h 29 min.
Peru	10° South	5 th February	June	11 h 35 min.
Senegal	20° North	5 th July	November	11 h 53 min.
Indonesia	10° South	5 th July	November	12 h 31 min.

Hours between Sunrise and Sunset in the Northern and Southern Hemispheres

Northern date	0°	10°	20°	30°	40°	50°	Southern date
5-Jan	12:07	11:34	10:59	10:17	9:27	8:14	5-Jul
20-Jan	12:07	11:38	11:05	10:31	9:47	8:45	20-Jul
5-Feb	12:07	11:44	11:19	10:52	10:19	9:32	5-Aug
20-Feb	12:06	11:50	11:35	11:16	10:55	10:23	20-Aug
5-Mar	12:06	11:58	11:49	11:38	11:28	11:11	5-Sep
20-Mar	12:06	12:07	12:06	12:06	12:07	12:09	20-Sep
5-Apr	12:06	12:14	12:25	12:35	12:49	13:08	5-Oct
20-Apr	12:06	12:24	12:41	13:02	13:27	14:03	20-Oct
5-May	12:07	12:31	12:56	13:26	14:02	14:54	5-Nov
20-May	12:07	12:37	13:08	13:45	14:32	15:37	20-Nov
5-Jun	12:07	12:41	13:17	14:00	14:53	16:09	5-Dec
20-Jun	12:07	12:42	13:20	14:05	15:01	16:22	20-Dec
5-Jul	12:07	12:41	13:19	14:01	14:55	16:14	5-Jan
20-Jul	12:07	12:37	13:11	13:49	14:38	15:46	20-Jan
5-Aug	12:07	12:32	12:59	13:29	14:09	15:02	5-Feb
20-Aug	12:06	12:25	12:44	13:06	13:35	14:14	20-Feb
5-Sep	12:06	12:17	12:26	12:40	12:55	13:16	5-Mar
20-Sep	12:06	12:08	12:10	12:13	12:16	12:22	20-Mar
5-Oct	12:07	12:01	11:53	11:46	11:37	11:26	5-Apr
20-Oct	12:07	11:52	11:36	11:20	10:59	10:31	20-Apr
5-Nov	12:07	11:44	11:20	10:55	10:21	9:36	5-May
20-Nov	12:07	11:38	11:07	10:34	9:51	8:51	20-May
5-Dec	12:07	11:35	10:59	10:19	9:29	8:18	5-Jun
20-Dec	12:07	11:33	10:55	10:13	9:20	8:05	20-Jun

STEP 2

WHERE WILL THE BIRDS BE TRANSPORTED TO AND FROM?

► This determines the number of hours at the end of the program.

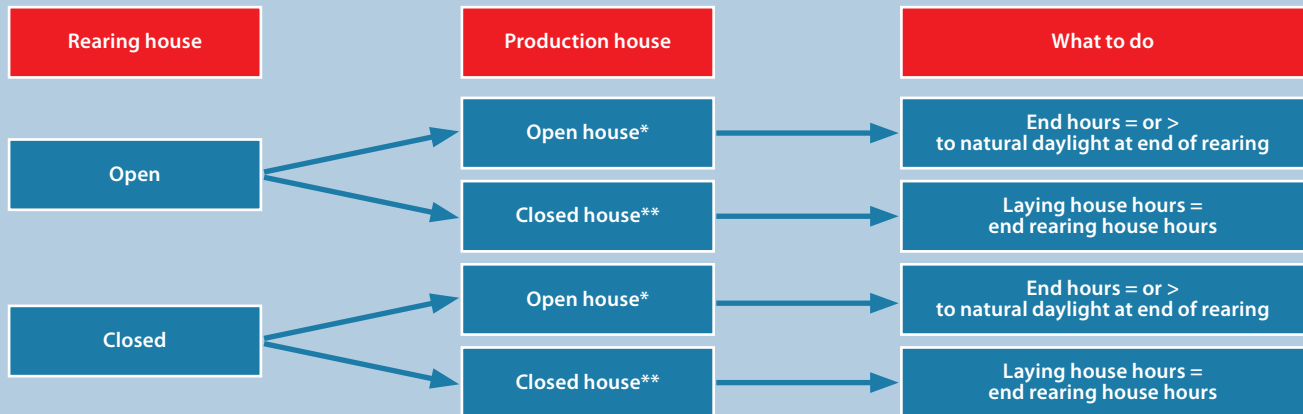

* Open house: any construction where you have > 3 lux. ** Close house: any construction where you have < 3 lux.

STEP 3

NUMBER OF HOURS IN THE REARING HOUSE

► Depending on limitations in step 1 and 2, determines the optimum end hours for your type of house: open or dark.

Shorter: ending at 10 – 11 hours / day

- Closed houses and when natural daylight allows
- Electricity savings
- Concentrate feed intake
- Feed intake challenge

Longer: ending at 12 – 14 hours / day

- Mostly open houses
- More time for feed intake
- Higher energy costs

► Remember: The hours of light at the end of rearing should equal the hours of light at the production house before the start of light stimulation.

STEP 4

SPEED OF LIGHT REDUCTION

► We recommend a moderate speed of reduction.

Moderate reduction until target:

- The moderate reduction is the best method to get the better egg size for incubation (58 to 60 grams) as quickly as possible. It is critical to keep the size under control as the flock ages.
- Have the less number of hours of light at 8 weeks for white PS and at 9 weeks of age for Brown Nick.
- Gives more time for feed intake
- The weekly reduction will depend on achieving the weekly body weights and uniformities.



GROWING (3 – 9 WEEKS)

STEP 5

LIGHT INTENSITY AT THE DESTINATION

► Light intensity should be adapted across the different rearing periods.

During the first week, a higher intensity is needed to activate the birds. After week 5, the light intensity should be decreased to calm the birds and prevent pecking and cannibalism. This is also recommended in open rearing houses.

In cages, light intensity should be measured at feeder and drinker level on bottom, middle and top tiers cages, mid-way between lights. Map the light intensity in the house. Use the bottom one to adjust light intensity to follow recommendations.

On floor/aviary, measure at bird level head, between light bulbs, at drinker and feeder level. Use the lower value to adjust to follow the recommendations.

On floor/aviary systems, try to bring light intensity in last 4 to 6 weeks of rearing on minimal of 10 lux for white and 15 lux for brown breeders to prevent floor eggs in production.

Light intensity should be measured at feeders and drinkers level.

Stimulate males and females at the same time and when body weight is in both at standard (18 weeks of age) and uniformity is more than 85 %

Example of lighting program for dark houses

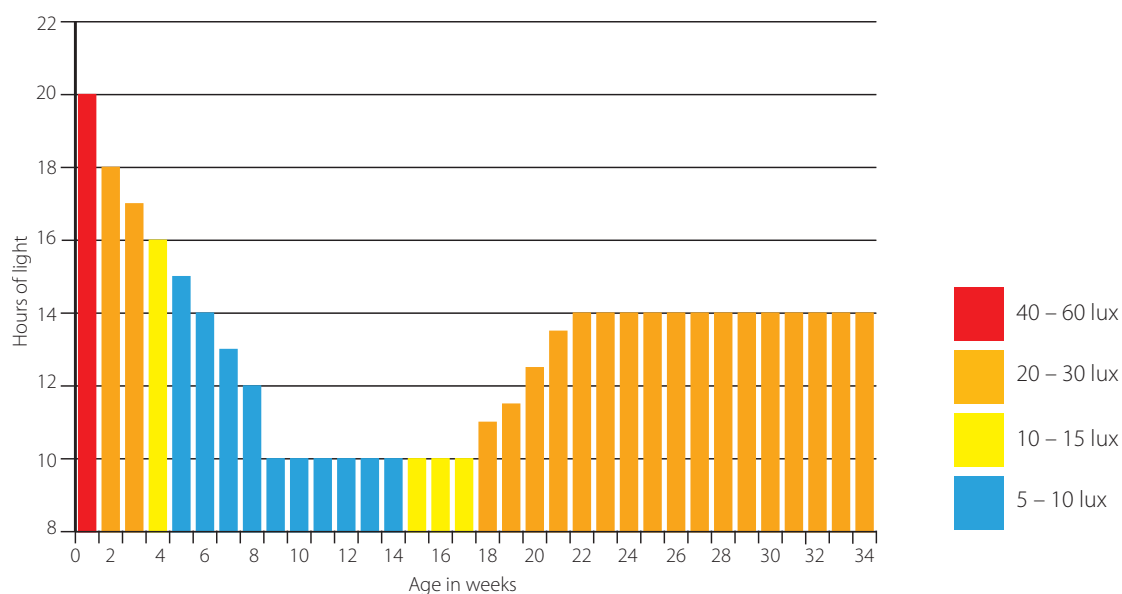

PULLET DEVELOPMENT

Pullets show extreme body growth during this period. This is especially true if we consider the percentage of growth compared with the previous body weight.

Even more importantly, at this stage the birds will develop most of their organs, skeletal system and muscles which are essential for their health and performance. Therefore, correct growth during this period is key to having healthy and productive adult birds.

If growth is delayed in this period, further compensatory growth is impossible: the

bone frame will stay as it is. The birds can reach the standard weight but the body content and size will differ and hens can become over fattened.

This also applies to male development; a correct body weight gain and uniformity is strongly related with good fertility. Always keep the body weight at standard and uniformity above 85 %

Change diets if body weight is on the target at the corresponding age: 0–5, 6–10 and 11 to 17 weeks (see the nutrition chapter). With a uniformity above 80 %. In case you didn't

achieve it, delay the change one or two weeks. Also, could delay the change in case of stress events, like vaccinations

It is very important to achieve the standard body weight during the first 12 weeks of age.

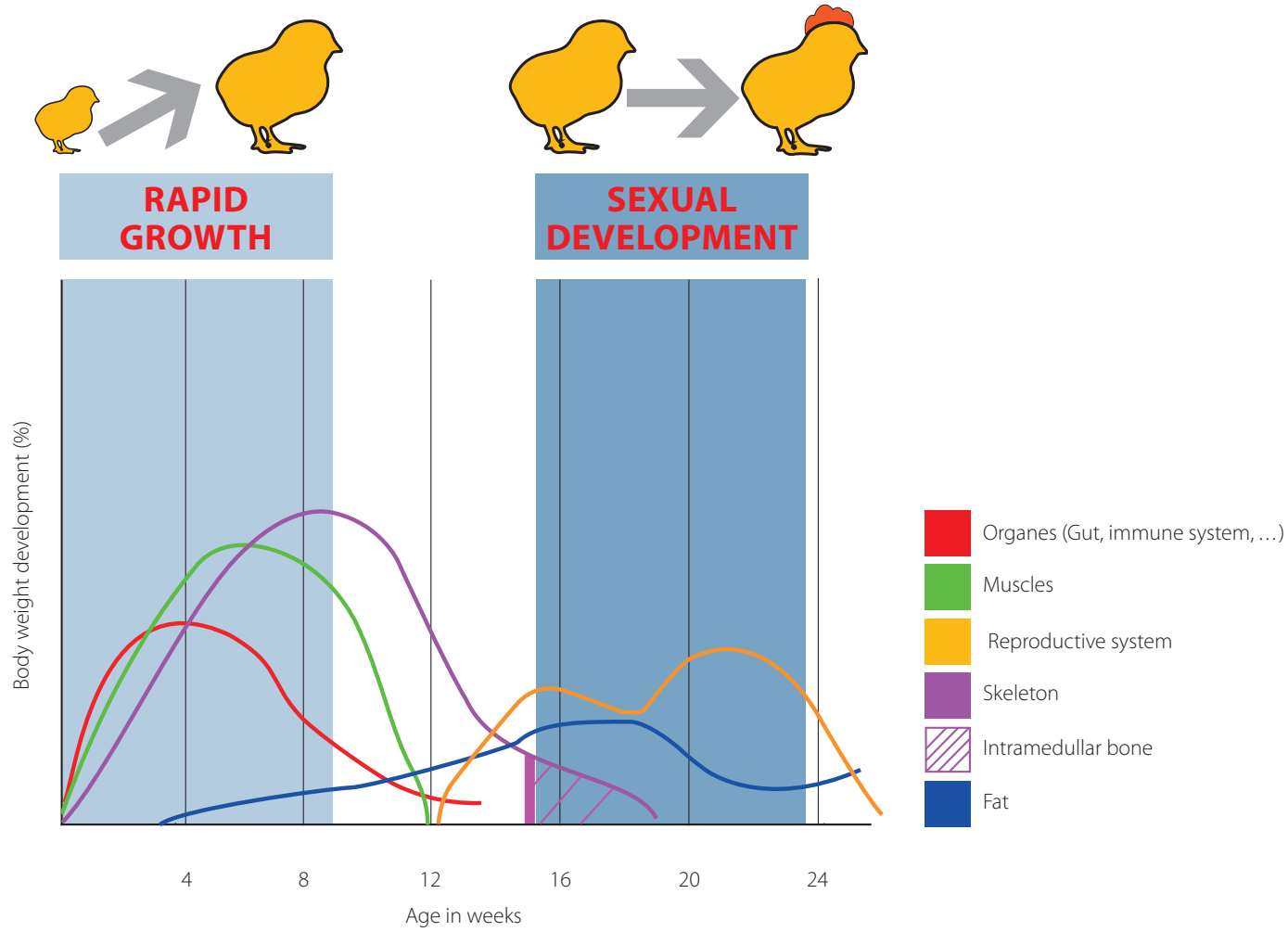



GROWING (3 – 9 WEEKS)

FEED INTAKE

Considering the importance of growth in this period, the daily consumption of the birds is below what it should be. It is very important to promote good feed consumption to maintain correct development:

- Temperature at week 3 should be 22–23 °C. This can be slowly reduced over the next few weeks to around 19 °C at 9 weeks of age.
- Maintain a low stocking density. In cage and aviary row rearing systems birds

should distributed along all the cages as soon as possible.

- Provide a “midnight snack” if the standard weight described in the section 8 is not reached or under hot climate. Follow the feeder and water space recommendations
- When possible, the feed intake training can start at 5–6 weeks of age. More details in page 32 of rearing period chapter.
- Providing good quality feed is also key to good bird development.

Please have an extra good look when you provide a midnight snack in floor/aviary systems concerning behavior chicks/pullets.

Daily feed intake pattern

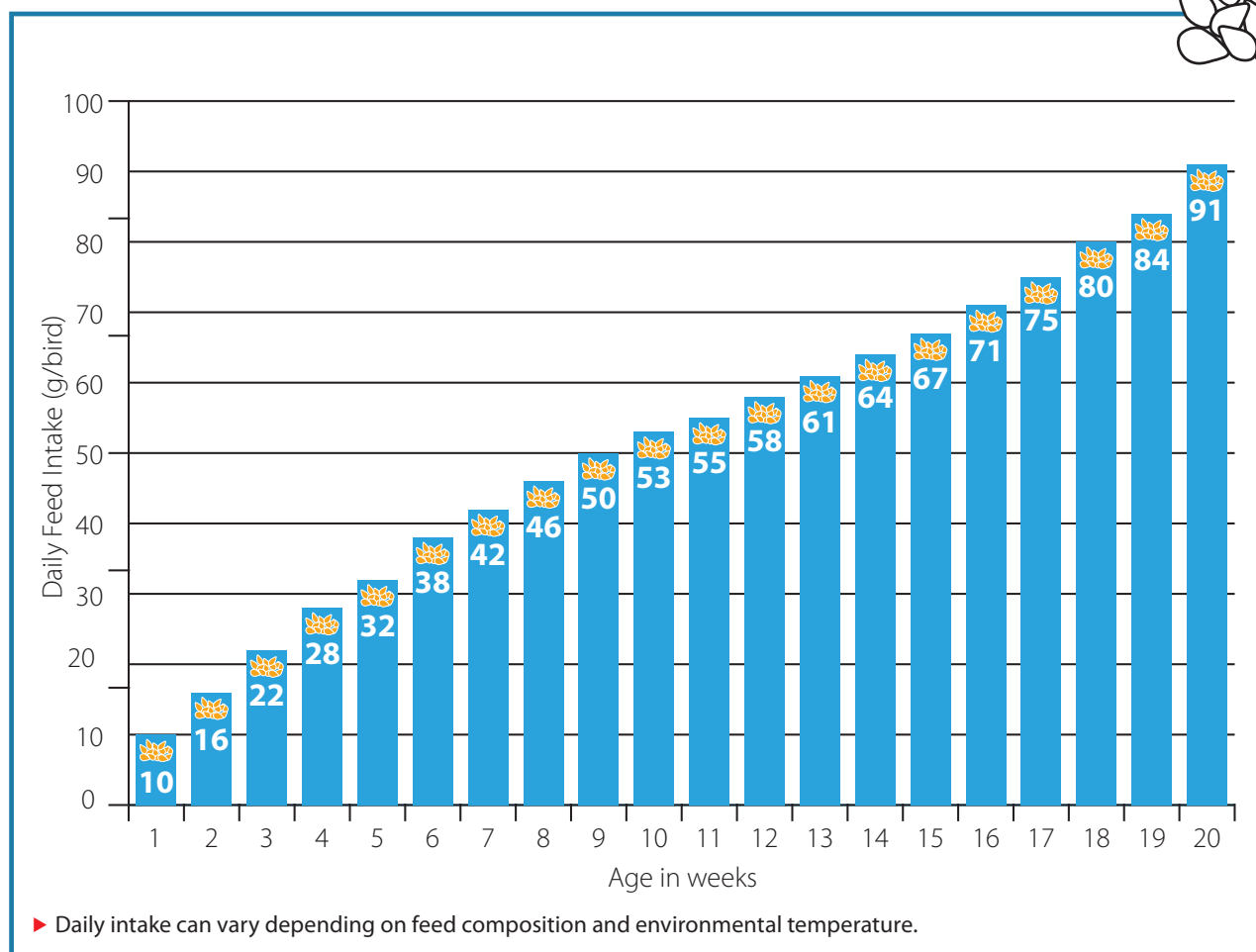

FEATHERING

Correct feathering is essential to enable a bird to regulate its temperature properly and is indicative of good development. A series of natural molting will occur during the rearing period: one complete molting (between 1 to 6 weeks) and three partials at 7 to 9 weeks, 12 to 16 weeks and 20–22 weeks when the stiff tail feathers are grown.

It is important that molting occurs in the indicated periods, otherwise it may signal delayed physiological development of the birds: nutritional, management, disease or any other problem.

It is important to periodically evaluate the feather conditions both during rearing and production periods. Loss of feather during production could indicate a stressor, impacting on the flock.

Feathering and molting

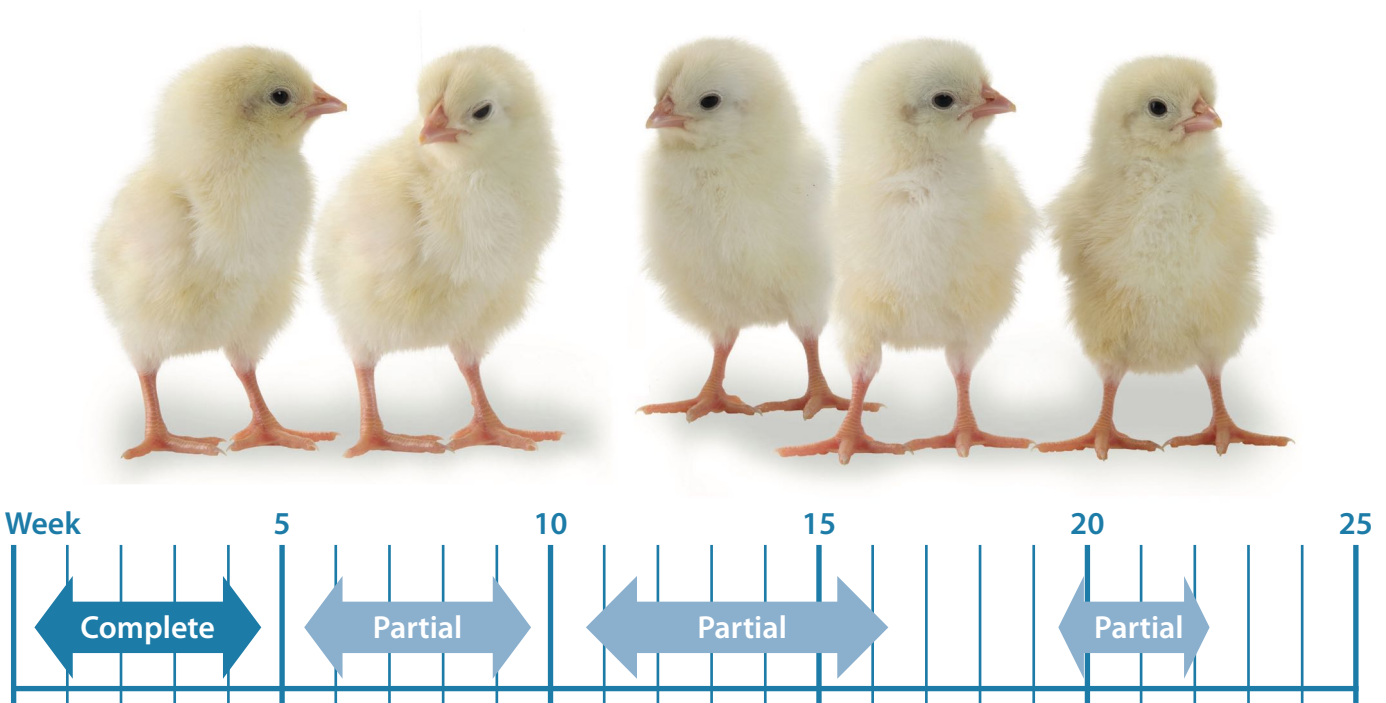

One of the tools to evaluate the status of the flock is by the primary feathers condition which can be done with certain frequency (for example, every other week). This can help us to either evaluate the status of feathering during rearing and production. Keep in mind that the number of molted feathers could give us an indication of the extent and magnitude of the stressor.

Here is a list of stressors that can impact on the flock inducing partial “molting” therefore impacting on the primary feathers development:

- decrease of daylight
- loss of body weight
- disease
- excessive cold or hot
- irregular feeding
- insufficient feed
- management (overcrowding, water deprivation or low flow)
- insufficient feed or water space
- ventilation issue), etc.

Some birds reduce body weight and production but never cease producing eggs; you could see excessive feathers on the floor or manure belt.



GROWING (3 – 9 WEEKS)

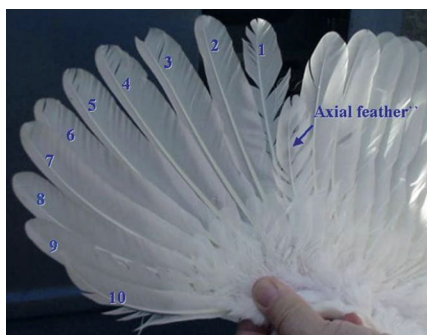

The axial and primary feathers on a wing of a chicken not in molt



Four feather molt, induced by an important stressor



One feather molt (First one); partial molting induced by a stressor.

Pictures from University of Kentucky: Evaluating Egg-Laying Hens

PERCHES

Perching improve nesting behavior, animal welfare, improve livability, bone/muscle structure and reduce floor eggs. They need to be placed as soon as 3 weeks of age.

Characteristics:

- Perches must have oval or round shape.
- Perches should have 8 to 12 cm of available space per bird (12 cm is best). The value depends on the bird density (higher value for high stocking density).
- At least 2,5 cm width or wider.
- Is recommended to place the perches as early as 3 weeks of age.
- Perches helps to reduce piling behavior.
- Perches improve bird welfare.
- Perches increase the floor space in the house.
- In case houses with 1/3 of floor with slats, always place the perches on the slats.

- Use the same type of perches in rearing and production.
- Preferably, place perches on the feeder line.
- Seal cracks, fissures and open ends of pipes to reduce areas where mites can hide.
- Positive effect on male/female behavior (aggressive males) for sure important in white breeders.

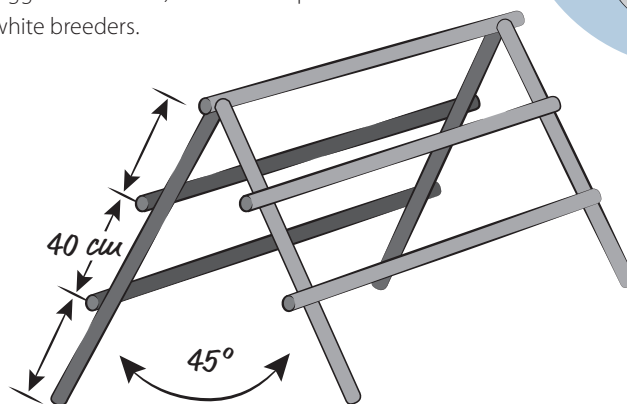
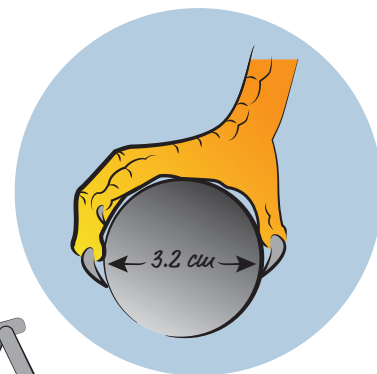

KEY POINTS

- ▶ Implement the lighting program according to your house conditions.
- ▶ Never allow day length to increase during the rearing period.
- ▶ Achieve the required body weight (males and females) during the first 12 weeks of age. with uniformity of at least 85 %.
- ▶ Provide enough feeder space as soon as possible.
- ▶ Follow the feathering and natural molting to check a correct physiological development.
- ▶ Males and females should be rearing together (cage and floor).
- ▶ Place perches at 3 weeks of age (floor rearing).
- ▶ Discard of sexing errors at 6 to 7 weeks of age.

REARING PERIOD (9 – 15 WEEKS)

- ▶ How to ensure weight gain and development during the last weeks of the rearing period.
- ▶ Weekly male body weight during the first 8 to 10 weeks is especially important for the development of the reproductive system and the future sperm production. Body weight must follow the standard, avoid any loose of body weight during this period.
- ▶ How to train the intake capacity to be ready for the production peak.
- ▶ How to prepare hens for the production period.

BODY WEIGHT

Weight gain slows during this period. That is especially true for the weekly percentage increase of body weight. However, the growth rate must be always maintained throughout this period.

Most of the skeleton and muscular systems have already been formed by now.

On the other hand, fat disposal improves during this period. A correct fat level in the body is necessary to achieve the production peak. Overfat females will face many issues in production (prolapse and pecking late in production) while overfat males could have fertility problems. Avoid over-fattening.

The feed intake is higher than in previous weeks. The birds may be given a more diluted feed.

If birds are within the weight standard or slightly above:

- Train feed intake capacity for the production peak challenge
- Promote weight CV

If birds are under the standard weight

- Some compensatory weight can be gained by maintaining grower feed for several weeks. However, this is very limited and the production period should be delayed.

*For weighing protocol see page 70.

Table 4: Body weight in rearing – Super Nick

Age (weeks)	Body weight Female	Body weight Male	Diet
1	65	70	STARTER
2	125	133	
3	187	200	
4	253	273	
5	325	356	
6	403	451	GROWER
7	484	557	
8	565	668	
9	645	775	
10	724	880	DEVELOPER
11	801	979	
12	876	1074	
13	949	1167	
14	1019	1256	
15	1085	1341	
16	1147	1424	ON-SET
17	1207	1503	
18	1261	1579	
19	1311	1652	
20	1358	1721	



REARING PERIOD (9 – 15 WEEKS)

FEED INTAKE TRAINING

During the last week of the rearing period, the nutritional requirement is not very high. However, it will change dramatically in the first weeks of production. To help the hens deal with this challenge it is beneficial to train them to increase their feed intake during the end of the rearing period.

To do this, try:

1. **Diluted feed:** From 10 to 15 weeks, it can be useful to switch to a feed (2700 Kcal, 15 % BP, 4.5% fiber) that promotes feed intake.
2. **Feed distribution program:** Allow hens to empty the feeders completely during the day.

3. **Move feed for the next day.** Once a week, you can withhold feed in the afternoon (20–30 % daily ration) and feed it the next morning instead. Check for uniform distribution and do not reduce the two-day ration.

Attn: this is only possible if the breeders are kept at the right stocking density and there is enough feeder space.

The feeding program should be similar to the one the pullets will have in production. You can start this program as soon as 5–6 weeks of age (growing period) when breeders are spread over all cages, or have access to all the living space in floor/aviary systems,

body weights (females and males) are at or above standard and uniformity is above 85 %.



Gizzard with (left) or without (right) feed intake training

Feed distribution in rearing from 10 to 16 weeks

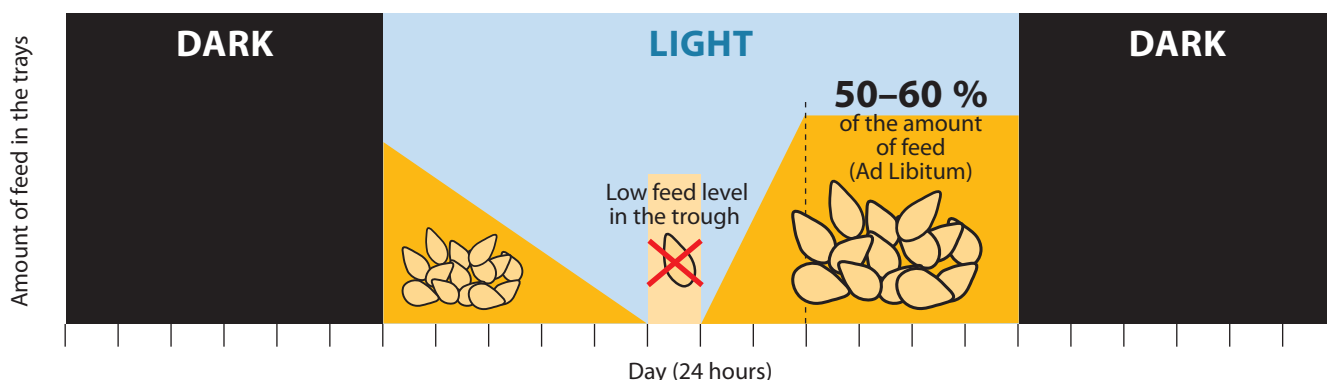

SEXING ERRORS

Even with good hatchery practice, some males will be confused with females and will be delivered and vice versa: some females will be delivered as males. such. It is best to separate them from the hens as soon as they are

identified. By 7 weeks or earlier, this should be very evident and this task can be easily performed. Non-productive hens can also be separated from the flock at the same time.

When white males are not comb treated, only mix with females when all the sexing errors were culled (around 7 weeks of age).

KEY POINTS

- ▶ Ensure body weight gain and correct development by maintaining feed consumption.
- ▶ Train hens to develop a good feed intake capacity by working with diluted feed and adapted feeding times.
- ▶ Remove non-productive birds from the flock.
- ▶ Remove sexing errors at around 6 to 7 weeks of age.

TRANSFER (15 – 18 WEEKS)

- ▶ How to prepare a flock for transfer to the laying house.
- ▶ How to transfer a flock correctly to the laying house.
- ▶ How to house a flock correctly in the laying house.

PREPARING THE BREEDING FLOCK TO MOVE TO THE LAYING HOUSE



We recommend transferring the birds between 16 and 18 weeks and once the vaccination program has been completed (at least one week after last killed vaccine). The birds should have time to become familiar with the new environment before they start to lay.

If the feed and water systems used in the rearing and the laying house are similar it will help the birds make a smooth transition. The same light program as in the rearing house should be applied. Good communication and coordination between the rearing and the laying house is necessary to synchronize flock management.

It is good management practice to visit the pullets several times during the rearing period.

Complete the vaccination program before transfer.

When possible do not administer vaccines during the transport of catching processes.

<p>PRODUCTION HOUSE</p> 	<ul style="list-style-type: none"> ▪ All reparation finished ▪ House clean and disinfected ▪ Feed in the silos ▪ Correct temperature ▪ Sampling of C&D process performed and satisfactory laboratory results received. ▪ Pre-heat the house in cold weather.
<p>FLOCK</p> 	<ul style="list-style-type: none"> ▪ Pullets on body weight ▪ Vaccine program administered ▪ Approved Sanitary certificate ▪ Flock information sent to production house (lighting program, feeding times, type of feed, body weight, ...)
<p>TRANSPORT</p> 	<ul style="list-style-type: none"> ▪ Transport truck ready ▪ Catching crew ready ▪ Housing crew ready ▪ Weather condition checked ▪ Personnel involved must have had two nights without had been in contact with birds.

STOCKING DENSITY IN THE LAYING HOUSE

The bird should have enough space, especially in hot climates. Important is not only cm² of cage floor/bird, but also the height of the cage and how many cm of feeder and how many drinkers are available per bird (a minimal recommendation is given in Table 1).

Keep in mind that overstocking has a strong impact on mortality, body weight and uniformity, feathering status, fertility and, finally, in hatchable eggs and chicks per hen housed.

Table 5: Stocking density at production house

Equipment	Requirements*
<p>Stocking Density</p> <ul style="list-style-type: none"> Colony cages Floor: only litter or 1/3 litter + 2/3 slat Floor: 100 % slat Aviary Systems 	<ul style="list-style-type: none"> 650–750 cm²/hen (13 to 15 birds / m²) 1.600 to 1.250 cm²/bird (6 to 8 birds / m²) 1.000 cm²/bird (10 birds / m²) 13 to 15 birds / m²
<p>Drinkers</p> <ul style="list-style-type: none"> Round drinkers Linear drinkers Nipple drinkers 	<ul style="list-style-type: none"> 1 drinker (Ø 46 cm) for 125 birds at least 2.5 cm / bird 1 nipple for 8–10 birds
<p>Feeders</p> <ul style="list-style-type: none"> Round feeder Chain feeder 	<ul style="list-style-type: none"> 1 feeder (Ø 40 cm) for 25 birds 10 – 15 cm / bird
<p>Nest</p> <ul style="list-style-type: none"> Family type nest boxes Family nest in family cages Single nest (26 x 30 cm) 	<ul style="list-style-type: none"> 100 hens / m² 50 cm²/hen (42 to 65 cm²) 4 to 6 hens per nest

*These recommendations should be adjusted to meet local regulations.



TRANSFER (15 – 18 WEEKS)

TRANSPORT PREPARATION

TRANSFER TO THE LAYING HOUSE

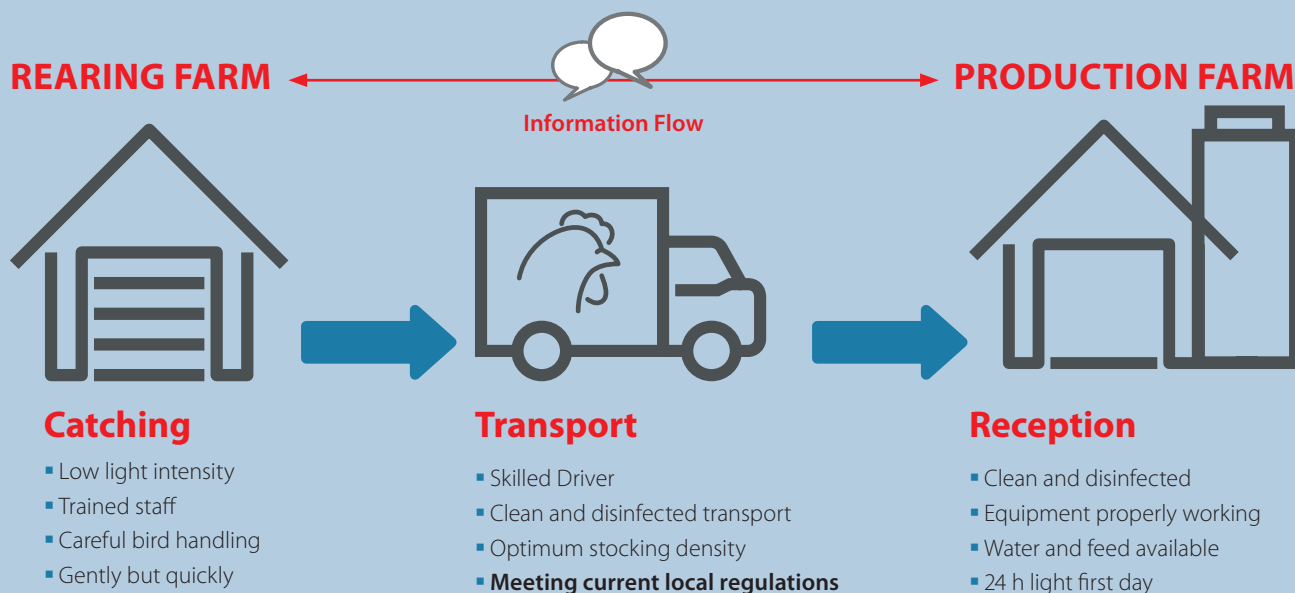

Preparation

Transport should be planned well in advanced and all staff involved should be informed. The crew must have been without contact to any other birds at least 2 days prior to the job (best to transport breeder after a weekend). Withhold feed for a few hours before loading but continue to provide fresh water. Transport equipment should be in good condition and thoroughly cleaned and disinfected. The staff in charge of handling and moving the birds should follow the biosecurity regulations, wear clean clothing and footwear that have not been exposed to poultry. Choose the best time of the day for transportation (especially in hot climates).

Loading

Load quickly but with care and maintain an adequate stocking density in the transport trolleys. Continue ventilating the house during the procedure. The staff should be well trained and should handle the birds according to animal welfare regulations, catching and holding the birds by both shanks. Ensure enough ventilation for the birds between loading and unloading.

Important:

- Load females and male breeders separate from each other (see male's management chapter for more details).

- Select any defective or unthrifty birds, and also birds that get into poor condition (males/females)
- Remove all the remaining sexing errors at this time. Sexing errors that remain in the flock will impair the genetic potential of resulting commercial stock. In addition, sexing and color sexing accuracy of commercial chicks will be adversely affected.

Transport

Transport time should be as short as possible, avoiding unnecessary stops. Avoid moving the birds during the part of the day with more extreme temperatures, or when climate conditions could have a negative effect on the birds.

In all cases:

- Do not catch hens by one wing or one leg or the neck.
- Do not overstock transport trolleys.
- Do not leave hens in trolleys in sunlight or unventilated areas.
- Do not load trolleys in closed and unventilated trailers.

Hens will lose some weight during the transport depending on the duration and the temperature. This loss will be quickly recovered if the housing conditions are correct.



When to move the birds?

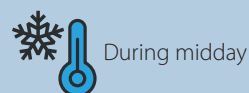

During midday



During the night or early morning

HOUSING IN THE LAYING HOUSE

Applying an “all-in all-out” system is recommended to break disease cycles and improve the health status. The laying house should have been thoroughly cleaned and disinfected in advance. The transfer should be done as smoothly and quickly as possible to allow the birds to be well prepared for the start of laying. The temperature in the laying house should be between 18 and 24 °C. Cool water and feed must be available when the pullets arrive at the house.

Water

In cage-free houses advise to use open water cups or 360 nipple drinkers. The drinkers should be at the right height and work adequately. Encourage the birds to drink - low water pressure in the drinker lines on the first days. During the first days check frequently that the birds are drinking. Adapting to a new drinker system could be difficult (especially if pullets have been reared with a different type of drinker). If water consumption does not increase in the days after housing, or it fails to reach normal levels, corrective measures should be taken at once.

Feed

Try to follow the same feeding program as used at the end of rearing.

Feeders should be filled when the pullets arrive so it is easy for them to locate the feed. Also encourage the birds to eat by running the feeding lines more frequently. If pullets are reluctant to eat after a couple of days, monitor feed and water consumption. Important is don't run feeders during the daily peak of production, to prevent hens moving out of the nests.

Pay attention to the male's adaption to the new feeders and drinkers. Fully combed males may have problems to eat if the feeders are not adapted for them (grill).

Light

In family cage houses a 24-hour light can be set during the first day, so the birds can become familiar with the new environment. After that, set the rearing house light program if possible.

In floor systems, use the same lighting program that was set in rearing. (Cage-Free) and make the dimming period at the end of the day manual for the first days, to train the breeders to find their way into the system. In this type of system is important, for the first 7 to 10 days after transfer, putting the birds to bed to prevent piling.

Light intensity can be a little higher during the first week (20 lux) to encourage hens to

explore the house. Avoid “light-shock (big step in light intensity between rearing and production) preventing stress and overstimulation.

Ensure a good light distribution to prevent dark spots that can impact on bird's behavior and to prevent as well, floor/system eggs at the start of production.

Weight

Weight lost during transport should be recovered in the first days in the house. The birds should continue gaining body weight and maintain a good flock weight uniformity to achieve a good start to production.

Keep weighing males and females weekly. Sometimes the females are gaining weight according to standard, but males have problems. This could happen when they weren't dub treated and have issues with the feeder's grill.

Behavior

Observe the behavior of the birds carefully and take actions if needed.



KEEP IN MIND

- ▶ In floor houses and aviaries, always check that the number of males per partition is the adequate.
- ▶ In family cages, after completing the unloading always check the number of males and females per cage.
- ▶ No vaccinations during transfer when possible.



TRANSFER (15 – 18 WEEKS)

MALES



Bad distribution: Males are too dominant and aggressive towards females

- too high male/female ratio
- too much difference in body weight
- males sexually matured earlier than females

Make a plan for a good distribution of the breeders in each cage, or in barn/aviary in every compartment and place the right numbers of males to keep the normal male/female ratio.

Accommodate (separate) the extra males in a pen/cages as soon as possible. This is to avoid possible aggressive behavior from males to females!

During housing is the last time to **make a good selection** of males and discards the ones with poor quality.

When you have experienced male's aggression in the past a recommendation in barn/aviary systems is to start with 3–4 % males. After 5–7 days, you can slowly bring in the additional males step by step during the night. Bring in 2 % males every week until you reach the right numbers of males. Do this during the night to avoid stress in the flock.

Having perches in the production house, help to reduce the social stress and the aggression on females.

Always is better to divide the house in compartments and place equally number of breeders per section. When well managed, this help to improve male:female behavior better feed distribution and less dirty eggs.

NESTS



Well maintained nests are critical for a good start.

The breeders should not be allowed to have access to the nest boxes too early.

Advise to open the nest boxes 1–2 weeks before the onset of lay.

Note that in aviary systems with one-line nest boxes, the birds need more time to find them!

Open the nest boxes 3–4 hours before start of day/lighting program, and close about 1 hour before end of lighting program.

LITTER



New and clean litter

Be sure that litter material is there in time the breeders start using the litter area in barn/aviary houses.

Different materials may be used:

- Wood shavings
- Cellulose pellets
- Coarse wood shavings

Regardless of the litter material used, it should be hygienic!

A litter level depth of 1–2 cm is sufficient.

Litter material should preferably be distributed after the house is pre-heated, and when the breeders have been housed.

This prevents the formation of condensed water between the floor and litter.

Keep the level of litter low and dry during whole production period!

KEY POINTS

- ▶ **Transfer the birds at least two weeks before the onset of lay (no later than 18 weeks).**
- ▶ **Only transfer flocks that are healthy and in good condition.**
- ▶ **Plan transport in advance and organize it well to ensure optimal comfort for the birds and biosecurity.**
- ▶ **Avoid transferring flocks during high temperatures. Transport by night if necessary.**
- ▶ **Monitor the body weight before and for the weeks after transfer to guarantee that the flock is developing correctly.**
- ▶ **Closely monitor water and feed consumption during the weeks after arrival at the laying house.**

ONSET OF PRODUCTION (18 – 22 WEEKS)

- ▶ How to manage the flock during the first weeks in the laying house.
- ▶ How to correctly apply light stimulation in line with flock status and production objectives.
- ▶ How to manage the flock to achieve a good production peak.

PERIOD AFTER TRANSFER

During the first days after housing, it is important to stimulate sufficient feed intake. The hens should increase their feed intake as fast as possible and continue gaining weight (see figure 1).

Some useful recommendations:

- Provide attractive feed with a good structure that avoids fine particles.
- Provide good quality, fresh water.
- Run the feeding lines frequently during the day.
- Feed on an empty feeder.
- Ensure there is enough light at the feeder
- Light intensity should be higher in the laying house than in the rearing house.
- Avoid excessive stimulation when transferring birds to open houses.
- **Crop filling score:** The goal is to have 100 % at 24 hours after transfer (check 100 females and 100 males). If is not 100 %, a complete review of all managements must be performed.

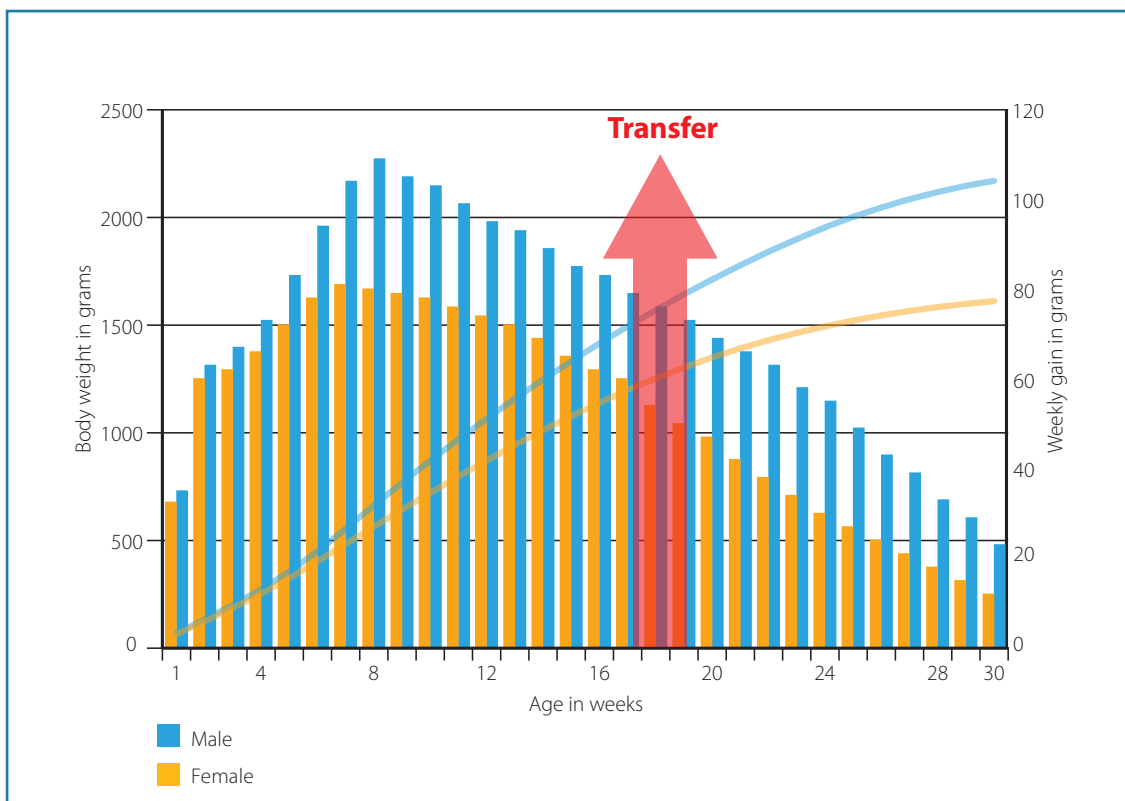



ONSET OF PRODUCTION (18 – 22 WEEKS)

LIGHT AND LIGHT PROGRAMS

There are two main factors that stimulate the onset of laying in the flock:

- ▶ **Body weight**
- ▶ **Photoperiod**

In the absence of other stimuli, hens will begin to lay when they reach an appropriate

body weight. However, the duration of the photoperiod can stimulate or delay the onset of lay as follow:

- Stable or increasing photoperiods with a duration exceeding 14 hours will stimulate the onset of lay.

- Stable photoperiods with a duration of less than 14 hours will delay the onset of lay.

Decreasing photoperiods should never be used in production period.

CHOOSE THE RIGHT STIMULATION AGE

▶ How to choose the right stimulation age

Normally a flock should be kept with a stable photoperiod until light stimulation starts. If hens are in the weight range, a standard recommendation for standard production is 18 or 19 weeks of life. However, this may vary according to:

- Flock body weight status: If the birds' body weight is far below the standard it is preferable to delay light stimulation for at least one week. Equally, if the uniformity is very low (less than 80 %) and/or the CV is very high (> than 10) and the weight of part of the flock is far behind the standard, later light stimulation is preferable.

The objective is to achieve as fast as possible an egg size of at least 50 to 52 grams, which is suitable for incubation. The goal is to reduce the number of un-settable eggs at the beginning of the production.

Never stimulate before 18 weeks of age. It is preferable to stimulate Brown Nick at 19 weeks of age.

TAKE THE NATURAL DAY LENGTH INTO ACCOUNT

▶ How to deal with natural day length

The light program in open houses should take the natural day length at the stimulation age into account. Determine the light program during rearing as explained in section X. Stimulation should differ depending on the day length.

- Increasing day length period: risk of flock being stimulated by natural light before they reach the correct body weight. To avoid this, the artificial day length should always be longer than the natural day length until the flock is ready to be stimulated. This should be considered in the rearing light program.
- Decreasing day length period: flocks exposed to decreasing day length can show delayed onset of lay. To avoid this, create an artificial day length longer than the natural day length from week 10.

To achieve this goal, use the app: H&N lighting program

USE CORRECT LIGHT STIMULATION

▶ How to apply light stimulation in a flock

Once the light stimulation age is defined, light stimulation starts with an initial photoperiod increase. Take the following into account:

- Increase the day length at least one hour after sunset, or after switching off the lights, and keep an eye on the start of production in the morning, and the risk that eggs are being laid before lighting program starts (floor/system eggs).
- Light intensity in the laying house should be slightly higher than in the rearing house
- Light distribution should avoid dark and shady areas
- Keep light sources clear

Subsequently, the photoperiod must be increased weekly. Light increases should be at least half an hour, although a higher increase is possible if the laying percentage increases rapidly. The more light hours the hens have, the more time they will use to consume feed. It is therefore important to achieve at least 14 hours of light to allow the flock to reach a proper feed intake.

MANAGEMENT UNTIL THE PRODUCTION PEAK

FEED



The birds need a good quality feed, with the structure and nutrient density necessary to suit their feed intake as well as provide their egg production, growing and maintenance requirements. Nutrient requirements in this phase increase rapidly so the feed intake of the birds should increase simultaneously. If not, the birds' nutrient requirement will not be met and they will be forced to mobilize their reserves. This may lead to soft bones and potentially harm the bird for the rest of the laying cycle. Switching to a layer diet with more than 2.5 % calcium stimulates the birds to lay eggs. This feed phase aims to cover the requirements to obtain the maximum egg mass.

Check if feeders are also accessible for males, they are bigger than females and have big combs that could be an obstacle in some feeder lines.



Mash Feed

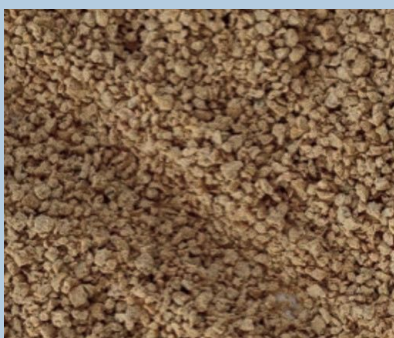

Crumble Feed

WATER



Cool water of good quality should always be available with the required water flow. Continuously monitor the water quality. Water consumption is normally 1.5–2 times higher than feed consumption. It is highly recommended to monitor the water consumption for early detection of possible problems. Regular cleaning and flushing of the water lines as well as the supply tank is essential. Water consumption will clearly increase at 10–14 days prior to the onset of lay. During this period, the ovary and reproductive organs will develop, and water will be stored in the follicles of the ovary

In aviary systems, keep an eye on levels where only water or feed is available. Pullets who don't move from one to another level will emaciate and/or dehydrate. You could pick up some pullets and look if there is water/feed in the crop.



Flushing system (water regulator)

SPACE



The birds should have enough space, especially in hot climates. Important aspects are not only cm² of cage floor/bird, but the height of the cage, which is especially important for males to allow a normal mating, how many cm of feeder, and how many drinkers are available per bird. The temperature should be between 18–24 °C.

VENTILATION AND TEMPERATURE

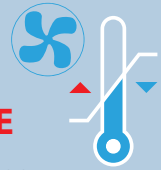

Proper ventilation should be used to guarantee good air quality in the house, and ensure a low concentration of gases and dust. At the same time, the temperature in the house should be optimally maintained between 18–25 °C (64.4–77.0 °F) with a relative humidity of 50–60 %. Birds do not tolerate temperatures above 30 °C (86.0 °F) well, especially if high temperatures are combined with high humidity. During heat stress, ensure that sufficient air circulates around the birds. The use of additional fans as well as evaporative coolers should be considered to reduce the house temperature. In aviary and floor production, ventilation and temperature is even more important to start with a good house temperature before transferring the pullets. The stocking density is less than cage systems, and we need good temperature and ventilation to stimulate pullets to find water and feed on the different levels in the system (important in aviaries). Mortalities smothering and floor/system eggs can be enhanced by poor ventilation.



Good air quality: you can see the back of the house



ONSET OF PRODUCTION (18 – 22 WEEKS)

NEST MANAGEMENT

Key points of using nest boxes in Cage-free systems:

- Right position of the nest boxes with drinking lines in front of them
- Use clean, automatic closing nest boxes with comfortable floor/mat.
- Nest boxes in the best right intensity of light (enough to find the nest, and inside dark enough to keep birds quiet).
- Enough nest space (refer to page 28)
- Breeders should not be allowed to have access to the nests too early. Open the nest boxes 1–2 weeks before the onset of lay. Open them 3–4 hours before start of day-lighting program and close 1 hour before the end of the lighting program (NEVER leave them open overnight)
- In an aviary system with on tier/level of nest boxes the birds need some more time to find the nests than a traditional floor house with slats or combi system where you have nest boxes on every level.
- System with on-line nest boxes can be equipped with incorporate barriers. Best way to use them every 2 meters at 6 meters from every compartment wall. This to prevent high density in these front and back nests.
- In case, of early production eggs you can also use very low light intensity lights inside the nests. This light can start 1–2 hours before the start of lighting program to give the birds that produce early to find the way to the nest boxes. These 1–2 hours are not included in the daylength.
- Always try to use more than standard nest space in cage-free systems to catch all the birds/eggs during the laying process. Especially at the onset of production of very uniform PS flocks.
- After the production peak and > 30 weeks, we can start gradually closing the nest boxes a bit earlier every 1–2 weeks. In the afternoon, the birds don't need access to the nest boxes. This is especially important if you start to see a lot of dirty nests (bedding or mat) and eggs due to nest material. In the afternoon, the birds don't need access to the nest boxes (after the production period – 10 hours after lights on.
- Close the nest in very small steps, and keep an eye on total number of eggs, and number of floor/system eggs. When these numbers stay same level, you can make the next step.
- For a correct nest management, always keep in mind the difference in the laying behavior between white and brown strains:
 - a) Browns tends to start the production earlier than whites, so the egg collection must start earlier.
 - b) In white flocks, at peak production hour a higher % of females are laying, plus the hens stay longer inside the nest than browns, therefore nest space is more critical for the white breeders than Brown Nick breeders.

Type of nest	Requirements*
Family type nest boxes	100 hens / m ²
Family nest in family cages	50 cm ² /hen (42 to 65 cm ²)
Single nest (26 x 30 cm)	4 to 6 hens per nest

*These recommendations should be adjusted to meet local regulations.



Manual nest: dirty and not enough nesting material: **ALWAYS** keep a clean and comfortable nest!



Type of nest in family cage



The management in the rearing period is critical to success in the training for nest use:

- Use of perches, water tables, etc.
- Lighting management.

The first 8 to 10 weeks post-hatch are critical to imprint the desirable behavior in our

birds. Therefore, the importance of optimizing the rearing periods, particularly for birds going into cage free housing systems is extremely important. Environments with simple rearing systems are not cognitively stimulating or spatially complex enough to adapt pullets to navigate in aviary or even on floor system.

If we don't provide perches or stimulate the pullets to jump on platforms in the rearing house, the chances to have a non-desirable % of floor eggs could be high.



Optimal set-up: with drinker lines close to the nest but not blocking the access to them, and a feeder line with the right height preventing laying eggs underneath it.



Wrong management of Manual nests: nests without platform. This structure is necessary to enhance the hens to explore and use the nests. Always keep enough and clean bed material.

MALES MANAGEMENT

Rearing

Males and females should be reared together from the first day if they are going to be under natural mating conditions in production. Males from white breeders without comb treatment need to be separate until 7 to 8 weeks of age to select the sexing errors. Do not dub brown males unless you have problems with feeders/grills in rearing or production.

Don't beak treat males (if you think you should beak treat them, ask H&N Technical service for advice). When is possible, males should be comb treated to avoid problems with feeder lines grills. This is a must when they will be housed in cages.

Males should be healthy and develop according to the standards as a predisposition for good mating behavior and good sperm quality. To achieve this, is important to follow the recommended stocking density, feeder and drinker spaces.

Check weekly male's body weight (always at standard) and uniformity (> 85 %). There are two critical periods when the body weight gain is extremely important and must meet the standard, the first is between 2 and 10 weeks of age, when the reproductive organs are developing and then, after light stimulation where is a fast growth of the testis.

At 10 weeks of age and before transfer (light stimulation) from rearing to the laying house a selection of the males should be made to only keep males in good conditions. Males with low body condition, leg problems, skeletal defects or bad feather cover will be sorted out. Furthermore sharp, hooked, short or uneven beaks should be selected since they can damage the females at mating.

All time, the stage of development should match to the development of the females based on comb, wattle and feather as indicators:

If their dominance develops too early, the males are getting active before a sufficient number of females is sexually mature, and as a result the males start chasing females, over-mating occurs, males start fighting each other, females are getting damaged and scared and as a final result, fertility is too low.

If their dominance develops too late, the males will not become dominant over the females and will be scared to mate with them. The males can be physically well developed but will not mate because they think they are not able to do so and as a result, again fertility is too low.

Production

Males in natural mating should develop dominance over the females otherwise they will not mate. Therefore, is important to keep an eye on the condition of the males during



ONSET OF PRODUCTION (18 – 22 WEEKS)

the laying period and check weekly the body weight development of the flock until week 30 and then biweekly.

Monitor carefully and permanently the sexual behavior of the flock and a good and even distribution of the males (especially important in the afternoon, during the mating period). An effort should be done to keep a good feather cover, otherwise females with naked backs will avoid males.

Depending on environmental condition the mating ratio ranges between 8 and 10 males per 100 females. In controlled environment, usually 8–9 % are optimal. In open or slatted floors and hot climate 9–10 % are recommended. Not always more is better, more males than needed causes disturbance in the flock resulting in reduced fertility.

It is a good practice to start at 20 weeks with 9–10 % males in natural mating and 7 % in artificial insemination and proceed to select males with poor condition during production to achieve 8–9 % and 6 % respectively of good quality males at 25–28 weeks of age and during production (for male/female ratio in family cages please ask H&N Technical Service).

Vent colour is a good indicator of the male's mating behavior, in an active male should be strong red and not pale and the variability of vent colour between males should be small.

Males with pale vents and underweighted should be sorted out.

In family cages, is critical to keep an eye on the males quality and behavior, because the decline in fertility could be faster than in floor systems. Every 2 weeks do fertility checks and when necessary apply intra-spiking or spiking. Always keep a group of extra males in a pen (better if they are younger than the flock; more details in the male's management Technical Tips).

Production System	Male / Female Ratio
Floor / Aviary System Controlled Environment	8 to 9 %
Ful slat or Hot Climate	9 to 10 %
Family Cages	10 %
Artificial Insemination	6 %

Fertility

If fertility problems appear in a flock check:

- Bad physical conditions of the males and females (overweight or underweight).
- Disease.
- Nutritional deficiencies.
- Sexual behavior of males and females.



Red vent of an active male



Pale vent of an inactive male



For further information, read the technical bulletin of Male's management

NATURAL MATING VS ARTIFICIAL INSEMINATION

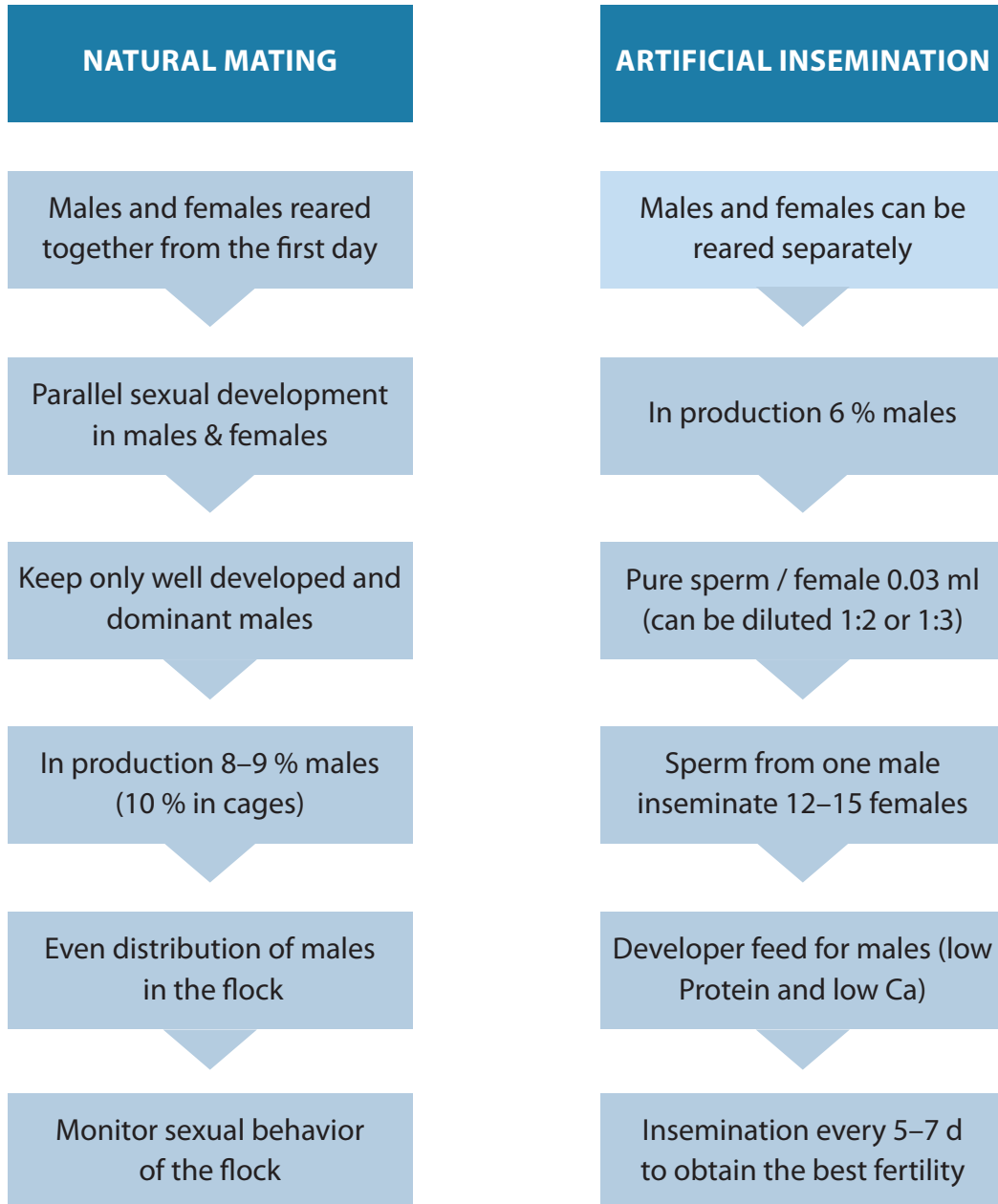



ONSET OF PRODUCTION (18 – 22 WEEKS)

ONSET OF LAY

Monitoring production data is essential for timely intervention in response to any issues that occur in the weeks between the first eggs and the production peak. Production data should be monitored daily or at least weekly.

% LAY

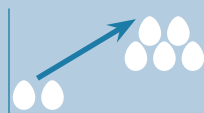

This should increase daily. During the first week, the increase may be small, but a bigger increase should be seen every day. In the middle part of onset of lay, the increase should be stronger, at least 2% per day and ideally close to 3%. Finally, in the last week, the increase should be close to 1% until the production peak is reached. The rate of increase cannot be monitored correctly if the eggs are collected at different times!

BODY WEIGHT



Increases could be a little erratic as not all the hens develop their reproductive system at the same time. However, body weight should never decrease, and a clear growth trend should be observed.

FEED AND WATER



As mentioned, consumption should increase every day. Water is the easiest parameter to monitor daily and is a critical management measure.

Female body weight and % lay until week 30

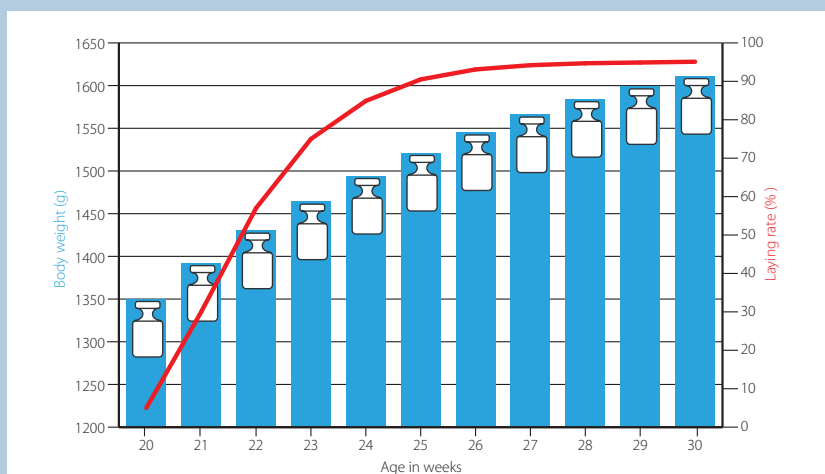

KEY POINTS

- ▶ Monitor how well the flock has adapted to the laying house by measuring water consumption daily and body weight weekly. Evaluate crop filling score 24 hours after transfer.
- ▶ Control the onset of lay and egg weight by correctly applying light stimulation.
- ▶ Never decrease day length in the production period.
- ▶ Closely monitor the increase in egg production, body weight (males and females), feed and water consumption during the weeks preceding the production peak. If the flock is not performing correctly, take corrective measures as soon as possible.
- ▶ Keep an eye on male's behavior especially during the last 4 hours of the lighting program.

PRODUCTION PERIOD (22 – 75 WEEKS)

- ▶ How to manage the flock to maintain optimal production levels during the production period.
- ▶ How to maintain the flock in good condition regarding body weight and feather covering.
- ▶ How to correctly manage the produced eggs.

PRODUCTION STAGE

After reaching a good production peak, H&N breeders should enter a production plateau. Their genetic potential allows them to maintain a high production level, optimal egg size and good eggshell quality for some weeks but to achieve this, pay close attention to certain aspects:

- Feed quality
- Daily intake
- Absence of diseases
- Body weight

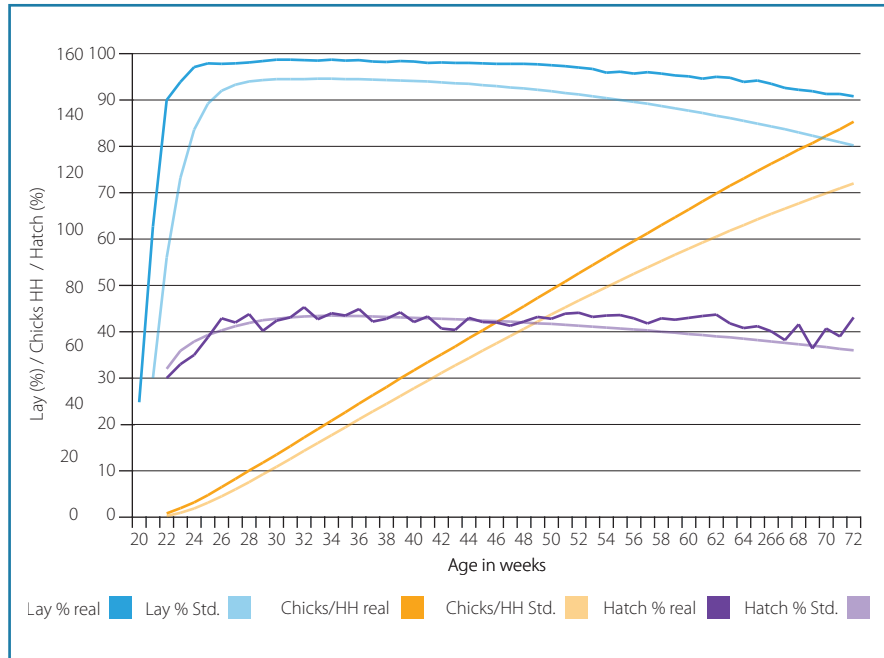

PRODUCTION MONITORING

Detailed laying cycle records are necessary to evaluate performance and profitability. Daily figures for hen-day production (total eggs and settable eggs), egg weight, feed and water consumption and mortality are necessary. This information will allow you to calculate very important data including daily egg mass, cumulative egg mass and feed

conversion. All results should be presented in graphs.

Use of graphs will improve analyses of flock performance trends. Growth records, accurate cage and / or pen counts are also very important. The spreadsheet should include the weekly hatchery results linked with the weekly farm results (weekly).

This enables timely intervention in response to any irregularities and generates historical data for more in-depth analysis of production performance.

H&N International provides you with good spreadsheets to enter your production data.

Flock				Rate of Lay			Egg Number		Hatching Eggs		Hatch-ability		Saleable Chicks		Rate of Lay					
Age	Act. hen number	Act. fem. Liveability	Standard Liveability	per H.D.	Standard	% Hatching Eggs	per H.H.	Standard	per H.H.	Standard	Saleable Chicks	Standard	per H.H.	Standard	per H.H.	Standard	Std. Hatching Eggs (%)	Act. number of males	Act. M. Liveability	



PRODUCTION PERIOD (22 – 75 WEEKS)

TROUBLESHOOTING

Problem	Possible cause
Lay drop	Low feed intake, low water intake, stress factors, feed quality, decreasing light program, pathology
Low feed consumption	Temperature, water supply, feed quality, inadequate feeder space, incorrect feed supply, pathology
Low egg weight	Temperature, low feed consumption, low body weight at light stimulation, incorrect feed formulation
Mortality	Flock uniformity, light intensity, stress factors, pathology
Low body weight	Incorrect feed formulation, low feed intake, high stocking density
High body weight	Incorrect feed formulation, overfeeding.
Floor eggs / System eggs	Incorrect training during rearing (use perches), not enough nest space, wrong nest structure, easy access to the nest, not optimal nest management (open and close), draft inside the nests, dark spots on the house, aggressive males at the beginning of production, feeding during production peak, wrong lighting program, wrong feeders management, feeder too close to the nest, low water flow, feeder and bell drinkers height (prevent hens laying under them). When slats are too high (> 45 cm), place ramps to facilitate the access from the litter area.
Cracked eggs	Ca/P ratio, Ca particle size, temperature, water quality, pathology, incorrect egg collection management, incorrect feed formulation, incorrect grading machine maintenance. Incorrect nest management and/or nest space. Compartmentalization in the production house helps to reduce the number of cracked and dirty eggs by ensuring an adequate use of the nest space.
Stained eggs	Water quality, pathology, incorrect egg collection management, incorrect feed formulation, incorrect grading machine maintenance, high stocking density, pest/diseases
Males aggression at start of production	Too many males → Check and adjust the male: female ratio; Place male and female together since day 1 or no later than 3–4 weeks of age (exception males with full comb). Keep the body weight close to the standard. In rearing, if the body weight is too way ahead of standard they will be sexually active earlier than females and could be aggressive towards them. If males weren't rearing together with females and/or body weight is more than 15 % ahead of standard and/or more than 45 % heavier than females is good to transfer them, starting with a low number and gradually add more males until you get the right ratio. When aggression start in rearing you can have a ratio of 4 % and slowly add more males. Also, compartmentalization and placing perches help to reduce male aggression.
Infertility	Males problem: too many, not enough, bad quality males, too old or too young; incorrect feed formulation (vitamins and minerals); high stocking density (especially in colony cages), females with bad plumage, overweight males and/or females.

FEATHER COVERING

Feather coverage is a key indicator of the hen's body condition. If hens lose their feathers, a drop-in fertility could happen because females would feel uncomfortable during mating. Also, their thermal insulation capacity will remain seriously impaired impacting directly on feed intake and maintenance energy needs. It therefore means an increase in the production feed costs.

Poor feathering can also be caused by stress or pecking. Excessive feather loss can be due to various factors including:

- Poor nutrition
- Pecking or social aggression
- High stocking density
- Harsh housing conditions
- High male's percentage (> 10 %)

Monitoring feather condition can help signal potential problems caused by aggression, nutritional deficiencies or other problems.

FEATHERING CONDITION SCORING

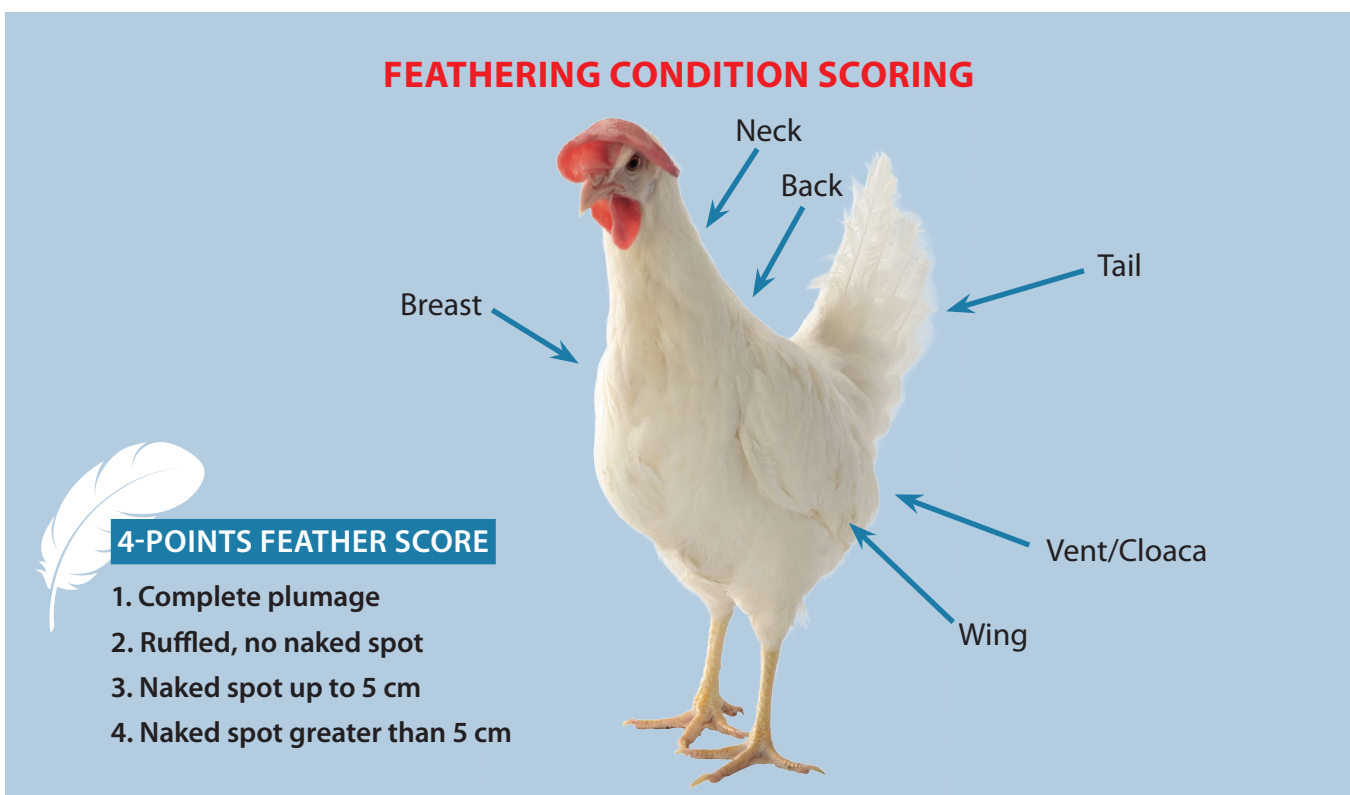

AGGRESSION

Occasionally, aggression and cannibalism can occur in the flock. This can affect hen welfare and their production performance. Behavior-related issues can have multiple causes, but certain management practices

can be applied to help prevent aggression and cannibalism:

- Control light intensity
- Correct rations, especially amino acids, sodium and fiber content
- Correct beak trimming – if permitted in your country
- Stress avoidance (noises, light intensity variation, etc.)
- Enrich the hens environment
- Adjust male: female ratio



PRODUCTION PERIOD (22 – 75 WEEKS)

FEEDING LAYERS DURING PRODUCTION

Layers do not consume equal amounts of feed during the whole of the day. 70 % of feed consumption occurs in the early hours of the morning and the last four hours in the afternoon. They also have a predilection for calcium during the last hours of light.

To mirror this behavior better, feed times should be adapted with the aim to leave feeders with a very low feed level around eight hours after switching on the lights. On the other hand, six hours before switching the lights off it can be interesting to concentrate 50 to 60 % of the

amount of feed given on that day. Ensure this afternoon feed is effectively distributed to the hens and throughout all the feeder lines.

Important that the birds go to sleep and wake up with a good level of feed.



Normal level



Low level

Feed distribution in production

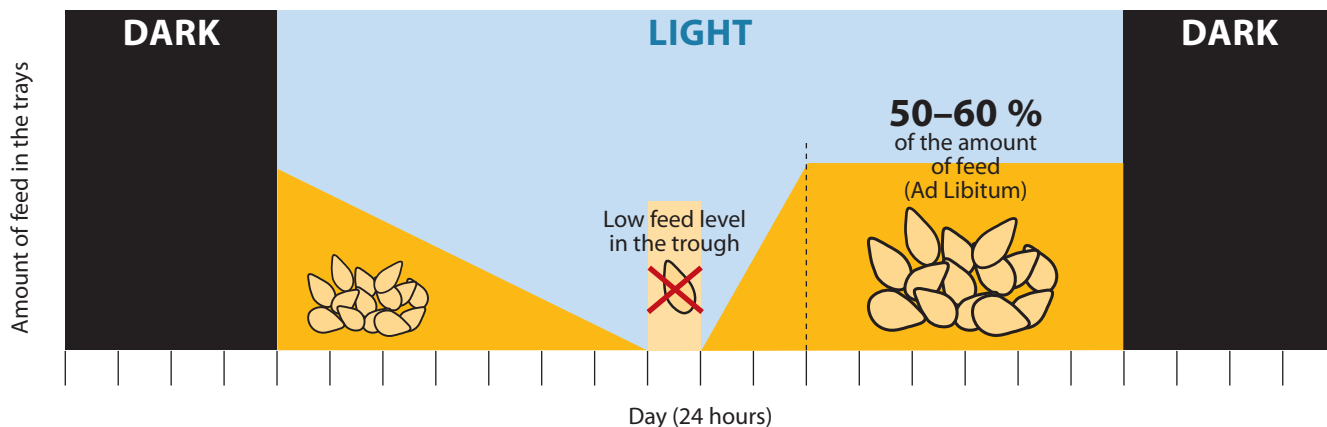

MIDNIGHT LIGHTING

Midnight Snack

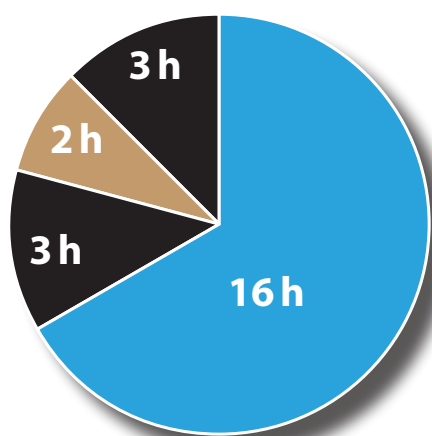

Darkness
 Light
 Midnight snack

This management technique is used to increase feed intake and allow calcium availability in the hours when the eggshell is formed, and its absorption is increased. It consists of lighting in the dark period to allow hens to feed and refill the crop. The following guidelines should be followed for correct application:

- Switch on the lighting for at least one hour and up to two hours. These hours aren't in addition to the normal period of light.
- Midnight period must be at least three hours after switching off the lighting and at least three hours before the lights switch on.
- Feeders must be filled before the lights switch on and always have water available.
- For floor / aviary systems is important to bring dimming period down around 15

to 20 minutes before the lights off to help breeders to look for the right place to sleep.

Midnight lighting can be used with different objectives:

- Increase in feed consumption. It can be used in rearing and/or production. It is especially useful in hot climates where birds are unable to feed properly in day time.
- Improvement of eggshell quality. The availability of extra calcium in the intestine allows better calcification and reduces bone decalcification.

Keep an eye on behavior of the flock during when using midnight feeding. Extremely important in Floor/Aviary production.



LAYING PROCESS

Egg process

Egg formation is a complex process that occurs in the oviduct of the hen. The whole process takes around 24 hours, but forming the eggshell takes most of the time (18–21 hours).

Lay is a critical moment for hens. If possible, they prefer a protected and dark area. The cloaca could be reversed during the lay process which can encourage cannibalism. If hens retain eggs due to stress, shell defects

may occur. Therefore, avoid disturbing hens during maximum laying hours to reduce this kind of defect. This means not disturbing them by removing dead birds, feed distribution, inspecting flock.

Laying window

The laying window is defined as the time in hours since the lay of the first egg to the last one. Its range varies between breeds of hens.

50 % of the lay takes place around 14 hours after switching off lighting or after the sunset. It is useful to know when most of the eggs have been laid. This information can also be used to advance or delay the time of sunset, although periods of 16 hours of light are used routinely.

There are differences between the laying window of Brown and white breeders. Brown Nick starts laying earlier than whites while SN/NC concentrate the production in a narrower window. Consider this when planning the hatching egg gathering and nest space.

Lay distribution during the day

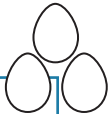
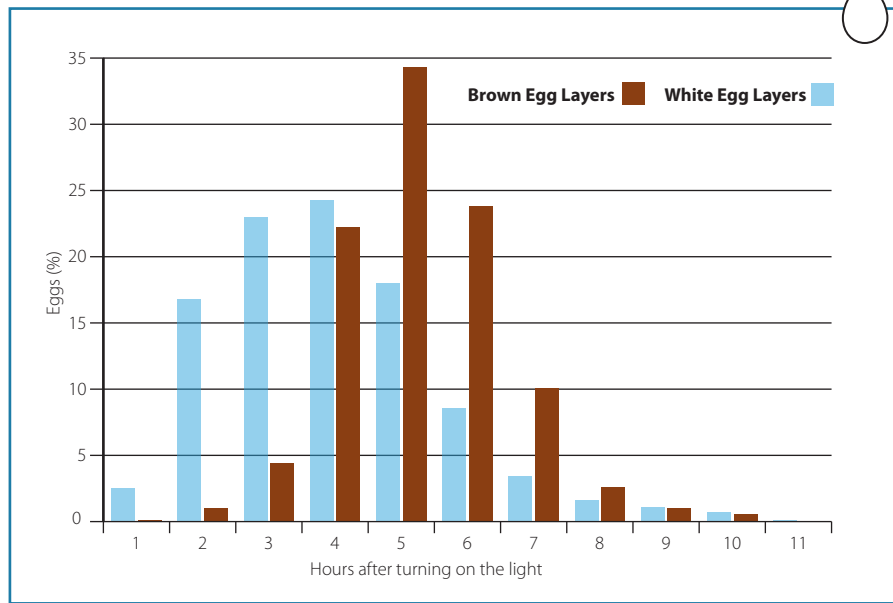



PRODUCTION PERIOD (22 – 75 WEEKS)

Mating behavior

The completed mating in chickens is the culmination of a sequence of behaviors which is completed when the cloacae of male and female come into contact and the rooster's ejaculate is released directly into the hen's vagina via her cloaca. In the typical breeder house with large population of birds the entire sequence of behavior does not always occur and most of the time we can only see the last part when the end of the mating behavior.

The frequency of mating follows a diurnal pattern with mating frequency reaching peaks early and mostly late in the day when more than 50 % takes place within 4 hours before lights going out at the breeder house. The first 3 to 4 weeks after transfer/light stimulation must visit the farm 3 to 4 hours before bedtime and see where are males and females? How are they (grouped, mixed) and sit down for 15 minutes to evaluate how is the mating behavior, do you see lots of mating or are the hens hiding?

As the male ages the frequency of mating decline, impacting on the flock fertility.

Frequency of Matings

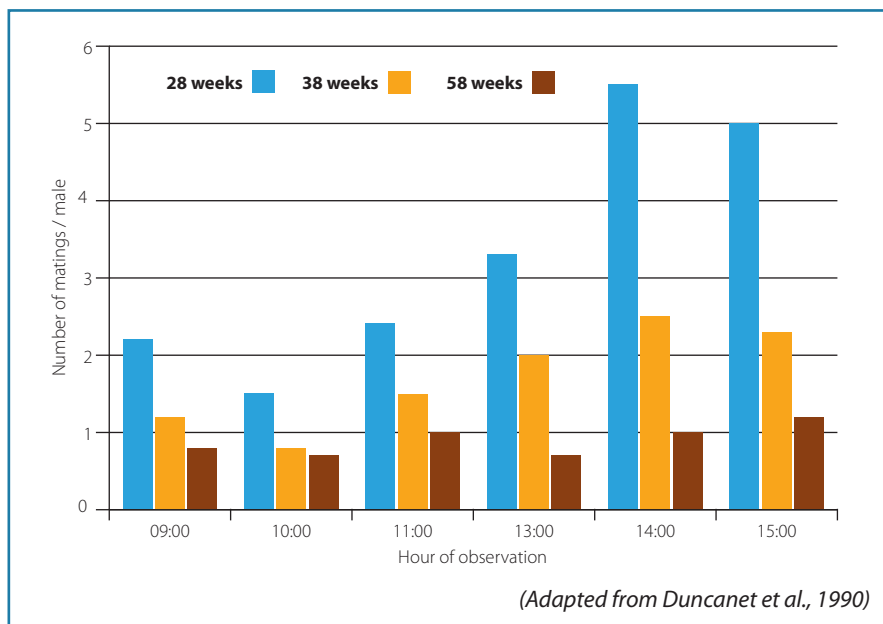

KEY POINTS

- ▶ Ensure a gain in body weight and correct development to maintain egg production.
- ▶ Correct management of feed distribution and feeding times
- ▶ Monitor body weight and feather covering in both, males and females.
- ▶ Monitor production outputs to enable corrective measures as soon as possible.
- ▶ Keep an eye on male behavior during the whole period. Especially important during both, the after transfer and production onset. Keep selecting weak and poor females and males.
- ▶ Evaluate the mating behavior in the first 3–4 weeks after light stimulation.
- ▶ Floor, system and dirty eggs are NOT hatching eggs.

HATCHING EGG MANAGEMENT

- ▶ **The fertile egg contains a living embryo which has all the genetic potential of H&N International. In order to enable embryo express this potential during incubation and later in life as pullet and laying hen, good hatching egg quality is essential.**

EGG WEIGHT

- Egg should weigh a minimum of 50 g and from a flock of 22 weeks of age or older to be incubated. In case of chicks delivered over long distance a minimum of 52 g is recommended.
- For best hatchability and chick quality, the Ideal egg weight is between 58 to 61g. Control the egg size to achieve this goal: lighting program, nutrition and pullet body weight.

EGG SELECTION

- Only incubate **CLEAN eggs. Floor and system eggs are not hatching eggs.** This selection must be done at the farm, therefore **NEVER A DIRTY EGG SHOULD ENTER THE HATCHERY.**
- Only incubate egg with normal shape and good shell quality (discard eggs with hairlines cracks).
- Quality control of the egg selection must be in place to evaluate the procedures: routinely check 60 to 90 eggs and calculate % of dirty, up-side downs, hairlines, etc. Record the result.

EGG DISINFECTION

- Disinfect as soon as you collect the eggs, while they are still warm (within 2 hours from laid).
- Only use product labeled for hatching eggs application.
- Always follow the directions: doses, exposition time and method of application.
- When is a high incidence of early deads (< 24 hours) is good to check the fumigation method.

NEST MANAGEMENT

- Good nest: enhances nesting behavior, keeps the eggs clean, and prevents damage on egg shell.
- Keep the nests clean. In manual nest always have clean, deep enough (2.5 cm / 1 inch), and good quality bed material.
- It is extremely important to keep a daily nest control. In manual nests, change the bed material and/or sanitize nest on time (every two weeks in automatic nests: daily and before start collecting egg must check the status of all nests (for example, if they are any missing covers or are all 100 % open) Check for non-productive females hiding inside the nests.
- Close the nest 2–3 hours before lights-off and open them back again before lights on. Never leave the nests open overnight.

EGG COLLECTION

- Collect the egg as frequent as possible. Preventing eggs pilling up in nests and belts.
- In manual nest, at least 4 times per day under normal temperature (18–25 °C). In summer/hot climate more frequently. Keep in mind that the goal is gather more than 90 % of the eggs in the first 7 hours after lighting on.
- In automatic nest, do not wait more than 3 hours since the start of the lighting period and do it continuously for the first 4 hours to avoid hairlines cracks.
- Egg collection is better in either disinfected plastic or setter trays. Always use trolleys that allow good air circulation among the eggs. Place the eggs in the trays with the air cell up (rounded end up).
- Never leave eggs overnight in the nests or belts.

EGG STORAGE

- After disinfection, quickly store the hatching eggs under optimal condition (within 5 hours from laid).
- Variation in temperature and condensation must be avoided all time.
- Important is have a good air circulation to create an even environment.
- Control temperature and humidity all the time. Use min/max thermometer and digital thermometer/hygrometer. The use of data loggers is recommended.
- If eggs stay for more than 3 days at the farm storage room, is necessary to control (75 to 85 % RH).
- Do not place controllers or sensors in direct airstream of the AC equipment.

Days in storage	Temperature	Relative Humidity
0–3 days	18–21 °C / 64.4–69.8 °F	75–85 %
4–7 days	15–17 °C / 59–62.6 °F	75–85 %
8–10 days	13–15 °C / 55.4–59.0 °F	80–85 %
More than 10 days	12–14 °C / 53.6–57.2 °F	80–85 %

When is not possible to have rooms with different temperatures a rule of thumb is to keep the eggs between 15 to 17 °C (59 to 62.6 °F) and a relative humidity of 75 to 85 %.



HATCHING EGG MANAGEMENT

TRANSPORTATION

- The transportation of hatching eggs from farm to hatchery is critical: avoid temperature fluctuations, bumps, and **prevent condensation**.
- Monitor the temperature during transportation. Best option is placing temperature data logger(s) inside the truck box.
- Clean and disinfect the truck box prior use.
- Only use the truck to transport hatching eggs and nothing else.

CONDENSATION

Condensation on the egg shell impairs the natural mechanisms of defense and provide an ideal environment for bacteria growth.

HATCHERY

- Place the eggs in setter trays soon after arrival to have good air circulation and cooling effect.
- The storage room must have good air movement.
- When eggs are stored for longer than 10 days, SPIDES is recommended.
- Check the cleanliness of the equipment having contact with the hatching eggs. For example, setter trays, suction heads of egg lifters, etc.

HAIRLINES CRACKED EGGS

Hairlines cracked eggs have low hatchability and poor chick quality. In case of a high incidence (> 2 %) a complete analysis of the hatching egg flow must be performed, identifying the impact points. Calculating the % of hair lines before and after impact points will identify equipment factor that could be damaging the egg shell. Example of impact points: nest, egg belt, egg lifter, conveyor, packing machine, etc.



Not enough nesting material = impact point

EXAMPLES OF UNSETTABLE EGGS



For more information please visit H&N website and read our Hatchery Management Guide located in the download section



NUTRITION

REARING NUTRITION

- ▶ How to develop the skeleton and muscle of the pullet at each phase.
- ▶ How to develop the feed intake capacity for the start of lay.

FEED DESCRIPTION AND MANAGEMENT

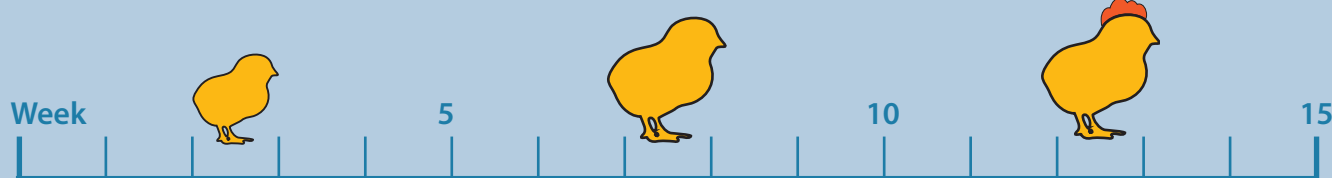

Starter feed

- High density diet with highly digestible raw materials.
- Investment that sets up the basis of skeletal and muscular growth of the pullet.
- Feed should always be available.

Grower feed

- Medium density diet with more variety of raw materials.
- This supports skeletal and muscular growth.

Developer feed

- Low density diet with raw materials high in fibre.
- Feed with significant levels of fibre or a higher particle size to develop the feed intake for the start of lay.

Changing diets

- Delay a change to the diet if the target body weight is not reached.
- If the body weight isn't achieved by 5 or 11 weeks of age, there is a need to review the nutrition, density and management in the previous weeks.
- If the birds are over the target body weight, the change to the next diet can be done a week earlier.

FORMULATION TIPS

Starter

- Crumble feed presentation will improve growth and make it easier to reach the standard body weight.
- It could be interesting to invest in highly digestible raw materials if they are available.
- Soy oil or coconut oil are better sources of energy than palm oil: at least during the first three weeks of age.
- A minimum of 0.30 % of salt will help to increase feed intake.

Grower

- Transition to mash feed if the starter was crumble feed.
- A minimum of 0.28 % of salt will help to have enough feed intake.

- A minimum of added fat will reduce the dustiness of the mash feed (1 – 2 % based on cost impact).

Developer

- Crude fibre level needs to be as high as possible based on the available raw materials (> 3 %, up to 5.5 %). See possible raw materials to supply the necessary fibre (table 9). These values can be applied, or even exceeded, as long as they are of good quality.
- If the available raw materials don't allow you to follow the recommendations below. Your Nutritionist should make a proportionally higher specification and the feed mill needs to make a higher particle size feed to compensate the lack of fibre.

- A minimum of added fat will reduce the dustiness of the mash feed (1 – 2 % based on cost impact).

Others

- Calcium particle size in pullet feed should be fine (average 1 mm).
- Enzymes: use and effect in the diet should be based on the available substrate in the diet.
- Antioxidants: protect against oxidation of the oils in the feed mill and the oxidation of fats and others in the diet.
- Organic minerals: provide additional benefits to the existing inorganics and may reduce the inclusion levels of the minerals.

NUTRIENT REQUIREMENTS

Fibre in the diet

- The feed intake development is one of the key factors for developing a pullet ready to lay. The feed intake capacity is related to the gut size, the addition of fibre in the diet expands the size of the gut and improves the feed intake capacity.
- The fibre concept is getting complex in poultry. There is new knowledge showing how different types have a different effect.

- Fibre can be classified like:
The total dietary fibre (TDF) is a sum of water soluble fibre (WSF), neutral detergent fibre (NDF), acid detergent fibre (ADF) crude fibre (CF) and acid detergent lignin (ADL).
- The addition of certain level of fibres since early ages will support the feed intake capacity (see table 10).
- There are several raw materials that can supply the necessary fibre in the diets to develop the feed intake capacity (table 9)

Energy

- The energy requirement in feed is given as a range because of the several systems available for energy evaluation.

Amino acids

- They follow the recommended Ideal Protein Ratio (table 7)

Vitamins and minerals

- See table 8



NUTRITION

Table 6: Nutrient recommendations for rearing period

Nutrient		Starter	Grower	Developer
		0 – 5 weeks	6 – 10 weeks	11 – 17 weeks
M Energy	Kcal/kg MJ/kg	2825 – 2950 11.83 – 12.35	2725 – 2850 11.41 – 11.93	2600 – 2750 10.89 – 11.51
Crude protein	%	20 – 19	18 – 17	15.5 – 14.5
Lysine	%	1.18	0.97	0.62
Dig. Lysine	%	1.00	0.83	0.52
Methionine	%	0.52	0.44	0.29
Dig. Methionine	%	0.44	0.37	0.25
Met. + Cysteine	%	0.88	0.78	0.52
Dig. Met + Cys	%	0.75	0.66	0.44
Threonine	%	0.78	0.68	0.43
Dig. Threonine	%	0.66	0.57	0.37
Tryptophane	%	0.23	0.20	0.15
Dig. Tryptophane	%	0.19	0.17	0.13
Isoleucine	%	0.81	0.74	0.47
Dig. Isoleucine	%	0.69	0.63	0.40
Valine	%	0.92	0.76	0.49
Dig. Valine	%	0.78	0.64	0.42
Argenine	%	1.24	1.02	0.65
Dig. Argenine	%	1.05	0.87	0.55
Calcium	%	1.05	1.00	0.90
Total Phosphorus*	%	0.70	0.60	0.58
Available Phosphorus*	%	0.45	0.41	0.37
Dig. Phosphorus*	%	0.41	0.38	0.32
Sodium minimum	%	0.18	0.17	0.16
Potassium minimum	%	0.50	0.50	0.5
Potassium maximum	%	1.20	1.10	1.10
Chloride minimum	%	0.18	0.17	0.16
Salt minimum	%	0.30	0.28	0.26
Choline total	mg/kg	1260	1240	1200

* without phytase

Table 7: Ideal Protein Ratio in rearing

	Starter	Grower	Developer
Lysine	100 %	100 %	100 %
Methionine	44 %	45 %	47 %
Met. + Cys.	75 %	80 %	85 %
Threonine	66 %	70 %	70 %
Tryptophan	19 %	21 %	24 %
Ile	69 %	76 %	76 %
Valine	78 %	78 %	80 %
Arginine	105 %	105 %	106 %

Table 8: Vitamin and trace mineral recommendation in rearing

		Rearing
Vitamin A*	IU	10000
Vitamin D ₃	IU	2000
Vitamin E	IU	20 – 30
Vitamin K ₃	mg	3**
Vitamin B ₁	mg	1
Vitamin B ₂	mg	6
Vitamin B ₆	mg	3
Vitamin B ₁₂	mcg	15
Pantothenic acid	mg	8
Nicotinic acid	mg	30
Folic acid	mg	1.0
Biotin	mcg	50
Cholin	mg	300
Cocciostat		as required
Manganese***	mg	100
Zinc***	mg	60
Iron	mg	25
Copper***	mg	10
Iodine	mg	0.5
Selenium***	mg	0.3

* Higher level might be possible according to local state and national regulations.

** double in case of heat treated feed

*** levels of organic trace minerals

Table 9: Inclusion level of raw materials rich in fibre

Raw material	Range (%)
Rice bran	5 – 15
DDGs	5 – 20
Wheat bran	10 – 20
Wheat pollard	10 – 25
Bakery by-products	5 – 10
Barley sprouts	5 – 8
Copra meal	5 – 10
Palm kernel meal	2 – 8
Sunflower meal	5 – 15
Lupins	5 – 10
Oat hulls	2 – 4

Table 10: Crude fibre levels in rearing

	0 – 5 weeks	6 – 10 weeks	11 – 17 weeks
Minimum	3 %	3.5 %	4 %
Maximum	4 %	5 %	6.5 %



NUTRITION

ONSET OF LAY NUTRITION

► How to develop feed intake as the bird is growing and laying its first egg

FEED DESCRIPTION AND MANAGEMENT

- A transition feed that supports the final development of the pullet and the nutrient need for the start of lay.
- This feed is recommended to use until you reach 70 % of laying rate and have an increasing feed intake curve.
- This feed could be given since week 17 as replacement of the pre-lay.

NUTRIENT REQUIREMENTS

- The ideal protein profile is the same as in the layer rations.
- The vitamins and minerals are the same as in the layer rations.
- Crude fibre: keeping high levels as in the developer feed supports the feed intake development.
- Try to have a level minimum of 3.5 % or higher.

FORMULATION TIPS

- The addition of fats will give the formulation room for the requested calcium and fibre.
- A minimum of salt, 0.28 %, will help in the feed intake stimulation.
- 60 % of the calcium carbonate should be in coarse particle size.

Table 11: Nutrient recommendations for the Onset period

Nutrient					
Energy	265 – 275 kcal/hen/day 1.109 – 1.151 MJ/hen/day				
Crude protein	16.0 g/hen/day				
	mg / hen / day		95	100	105
Lysine	847	%	0.892	0.847	0.807
Dig. Lysine	720	%	0.758	0.720	0.686
Methionine	424	%	0.446	0.424	0.403
Dig. Methionine	360	%	0.379	0.360	0.343
Met. + Cysteine	762	%	0.802	0.762	0.726
Dig. Met + Cys	648	%	0.682	0.648	0.617
Threonine	593	%	0.624	0.593	0.565
Dig. Threonine	504	%	0.531	0.504	0.480
Tryptophane	186	%	0.196	0.186	0.177
Dig. Tryptophane	158	%	0.167	0.158	0.151
Isoleucine	678	%	0.713	0.678	0.645
Dig. Isoleucine	576	%	0.606	0.576	0.549
Valine	741	%	0.780	0.741	0.706
Dig. Valine	630	%	0.663	0.630	0.600
Argenine	881	%	0.927	0.881	0.839
Dig. Argenine	749	%	0.788	0.749	0.713
Sodium	180	%	0.189	0.180	0.171
Potassium	500	%	0.526	0.500	0.476
Chloride	180	%	0.189	0.180	0.171
Calcium	3600	%	3.790	3.600	3.270
Phosphorus	600	%	0.630	0.600	0.570
Avail. Phosphorus	420	%	0.440	0.420	0.400
Dig. Phosphorus	360	%	0.380	0.360	0.340

NUTRITION

LAYING NUTRITION

► How to feed hens for achieving as many as saleable eggs as possible during the laying period.

FEED DESCRIPTION AND MANAGEMENT

Type of feed

- The feed should fulfill the maintenance, growth and production needs. The feed should be adjusted when:
 - **Egg mass changes:** DO NOT change amino acids if the % lay drops unless the egg mass (% lay x size egg) is dropping too;

- **Body weight changes:** body weight affects energy needs, around +/-4 kcal every 50 grams of body weigh change;
- **Calcium and phosphorus requirement changes:** the phosphorus requirement decreases and the calcium requirement increases as the bird gets older;

- **Feed intake changes:** housing temperature will impact the feed intake. Hot temperature reduces the feed intake and vice versa.

Chart 1: Flow diagram based on raw materials variability through the feed management on farm

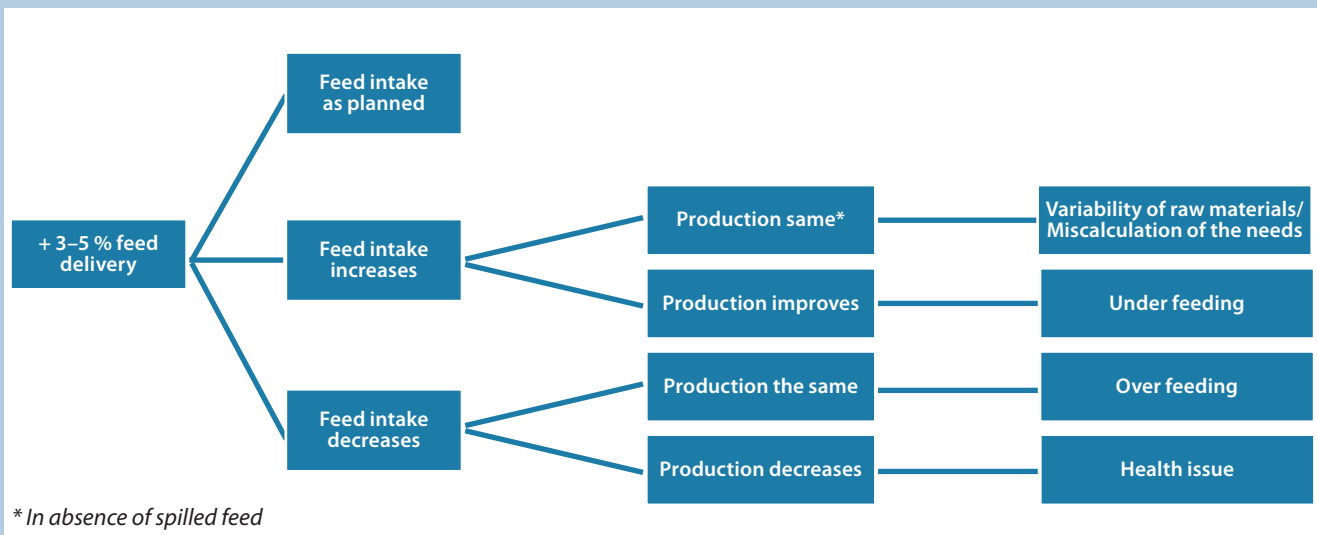

Feed management on farm

- Due to the variability of the raw materials the nutrient composition of the feed varies, to avoid this challenge we recommend to follow the Chart 1 decision tree:

Feed recommendation

- 40 % in the morning and 60 % in the afternoon (chart 2).
- Layer hens should clear all feed left in the feeder during the noon period.
- The time at which the feeder is empty depends on the lighting program.

Chart 2: Daily feed intake pattern

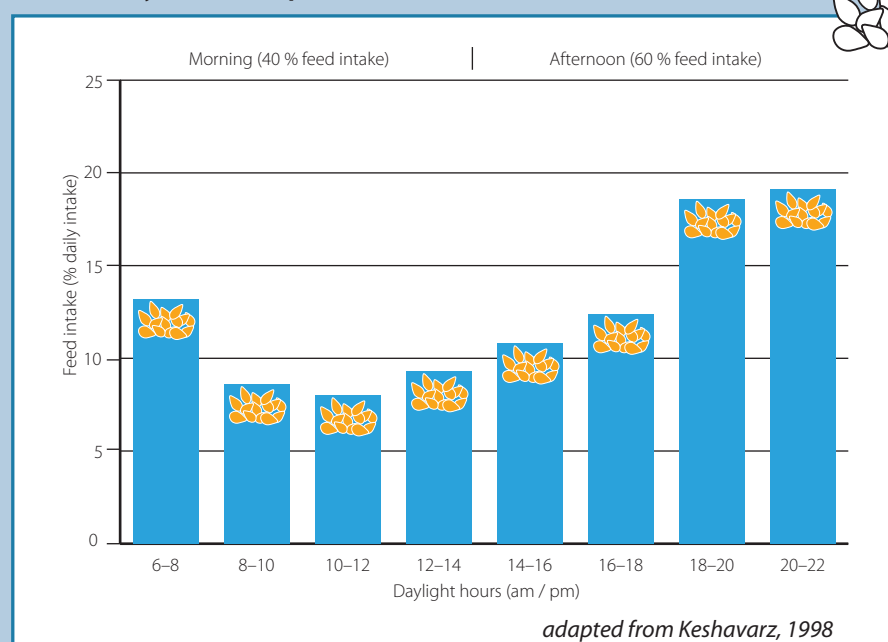



NUTRIENT REQUIREMENTS

- Recommendations below are based on egg mass production.
- After the Onset feed it is recommended to use the 60–58 egg mass recommendation until the target egg weight is achieved. The other recommendations can be applied to control the egg size on target or when the egg mass production drops as the layer hen gets older.

Energy

- The energy recommendation of this guide doesn't take into account the effect of the temperature in the needs of the layer hen. It needs additional adjustments by the nutritionist.
- Most of the energy intake will be used for maintenance. The body weight of the bird drives the energy requirement (see chart 3).

- There are different models to approach the energy evaluation, literature references (INRA, FEDNA, NRC ...) usually in MEn and calculations based on formulas, whereby the different elements of the raw materials are taken into account. Due to the variability of the values given by different systems, the recommendation of energy is defined as a range.
- Energy recommendation is calculated for a specific body weight of the bird and might need adjustments (see foot notes of table 12).

Amino acids

- Most of the amino acid intake will be used for egg mass production. The egg mass, % lay x egg size, drives the amino acid needs (chart 4)
- The total amino acid recommendation is based on a feed with 85 % digestibility. It

will need further adjustments by the nutritionist based on the digestibility of the diets of each customer. The formulation can be done using total or digestible AA. Do not use both values at the same time.

- Working with digestible AA is highly recommended when low digestible raw materials are used in the diet (see table 19 for the Ideal Protein Ratio recommendation).

Minerals and vitamins

- The vitamin and mineral requirement is shown in table 16.

Ca/P

- Ca and P requirement is shown in table 20.
 - Adapt the data in table 15 to suit the feed intake target.
 - Example: Av P requirement after peak 380 mg: if feed intake is 115 grams, the minimum amount in feed should be 0.33 %.

Chart 3: Daily requirements of energy of the bird

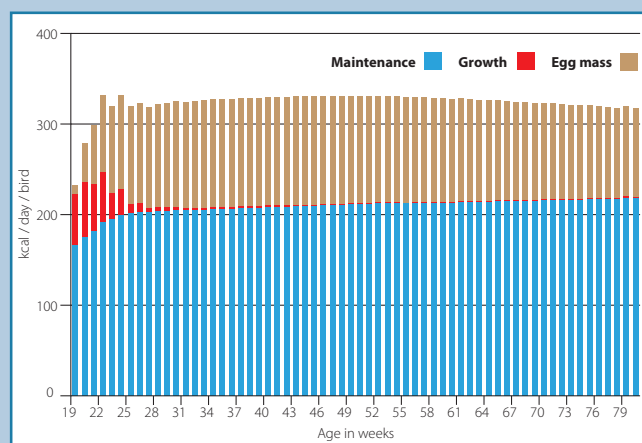
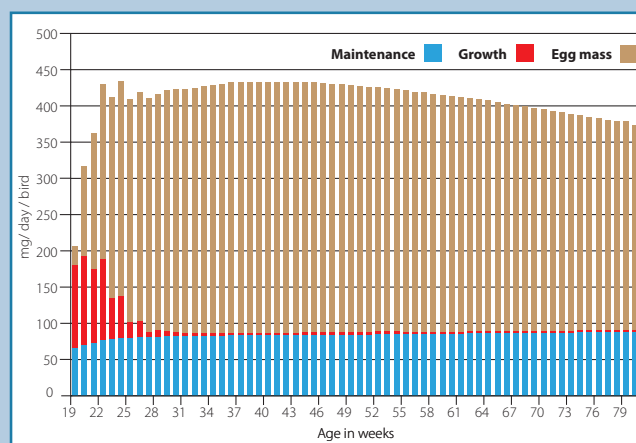

Chart 4: Daily requirements of digestible Methionine



FORMULATION TIPS

Crude Protein

- Using the minimum amount of crude protein is recommended if there is limited information about the raw materials.

Fat

- Added fat will reduce the dustiness of mash feed (1 – 2 % based on cost impact).

Ca/P balance

- Levels of Ca and P must be adapted as the layer hen gets older.
- An excess or deficiency of P can cause eggshell issues in the short or long term.
- Coarse limestone is necessary for eggshell quality. It can be replaced in part by oyster shells.
- Table 23 indicates the limestone particle ratio in layers.
- Table 22 indicates how much grit should be added directly to the feeding system.

Others

- Enzymes: use and effect in the diet should be based on the available raw materials in the diet.
- Antioxidants: protect against oxidation of the oils in the feed mill and the oxidation of fats and others in the diet.
- Organic minerals: provide additional benefits to the existing inorganics and may reduce the inclusion levels of the minerals.

Table 12: Nutrient requirement for a daily egg mass target of 55 – 57 g/hen for Super Nick PS

Energy*	291 – 306 kcal/hen/day 1.218 – 1.294 MJ/hen/day				
Crude Protein	16.8 g/hen/day				
	mg / hen / day		105	110	115
Lysine	941	%	0.896	0.856	0.818
Dig. Lysine	800	%	0.762	0.727	0.696
Methionine	471	%	0.448	0.428	0.409
Dig. Methionine	400	%	0.381	0.364	0.348
Met. + Cysteine	866	%	0.825	0.787	0.753
Dig. Met. + Cys.	736	%	0.701	0.669	0.640
Threonine	659	%	0.627	0.599	0.573
Dig. Threonine	560	%	0.533	0.509	0.487
Tryptophane	226	%	0.215	0.205	0.196
Dig. Tryptophane	192	%	0.183	0.175	0.167
Argenine	980	%	0.934	0.891	0.853
Dig. Argenine	833	%	0.794	0.758	0.725
Valine	824	%	0.784	0.749	0.716
Dig. Valine	700	%	0.667	0.636	0.609
Isoleucine	753	%	0.717	0.684	0.655
Dig. Isoleucine	640	%	0.610	0.582	0.557
Sodium	170	%	0.162	0.155	0.148
Potassium	500	%	0.476	0.455	0.435
Chloride minimum	170	%	0.162	0.155	0.148
Chloride maximum	310	%	0.295	0.282	0.270
Linoleic acid	155	%	1.476	1.409	1.348

* The energy needs are calculated for a body weight of 1660 g. Every 50 g of change will have an impact of +/- 4 kcal / bird / day



Table 13: Nutrient requirement for a daily egg mass target of 52 – 54 g/hen for Super Nick PS

Energy*	285 – 300 kcal/hen/day 1.193 – 1.256 MJ/hen/day				
Crude Protein	16.2 g/hen/day				
	mg / hen / day		105	110	115
Lysine	900	%	0.857	0.818	0.783
Dig. Lysine	765	%	0.729	0.695	0.665
Methionine	450	%	0.429	0.409	0.391
Dig. Methionine	383	%	0.364	0.348	0.333
Met. + Cysteine	828	%	0.789	0.753	0.720
Dig. Met. + Cys.	704	%	0.670	0.640	0.612
Threonine	630	%	0.600	0.573	0.548
Dig. Threonine	536	%	0.510	0.487	0.466
Tryptophane	216	%	0.206	0.196	0.188
Dig. Tryptophane	184	%	0.175	0.167	0.160
Argenine	938	%	0.893	0.852	0.815
Dig. Argenine	797	%	0.759	0.724	0.693
Valine	788	%	0.750	0.716	0.685
Dig. Valine	669	%	0.638	0.609	0.582
Isoleucine	720	%	0.686	0.655	0.626
Dig. Isoleucine	612	%	0.583	0.556	0.532
Sodium	160	%	0.152	0.145	0.139
Potassium	500	%	0.476	0.455	0.435
Chloride minimum	160	%	0.152	0.145	0.139
Chloride maximum	310	%	0.295	0.282	0.270
Linoleic acid	155	%	1.476	1.409	1.348

* The energy needs are calculated for a body weight of 1660 g. Every 50 g of change will have an impact of +/- 4 kcal / bird / day

Table 14: Nutrient requirement for a daily egg mass target of < 51 g/hen for Super Nick PS

Energy*	279 – 294 kcal/hen/day 1.168 – 1.231 MJ/hen/day				
Crude Protein	15.5 g/hen/day				
	mg / hen / day		105	110	115
Lysine	860	%	0.819	0.782	0.748
Dig. Lysine	731	%	0.696	0.664	0.635
Methionine	430	%	0.409	0.391	0.374
Dig. Methionine	365	%	0.348	0.332	0.318
Met. + Cysteine	791	%	0.753	0.719	0.688
Dig. Met. + Cys.	672	%	0.640	0.611	0.585
Threonine	602	%	0.573	0.547	0.523
Dig. Threonine	512	%	0.487	0.465	0.445
Tryptophane	206	%	0.197	0.188	0.179
Dig. Tryptophane	175	%	0.167	0.159	0.153
Argenine	896	%	0.853	0.814	0.779
Dig. Argenine	761	%	0.725	0.692	0.662
Valine	752	%	0.716	0.684	0.654
Dig. Valine	639	%	0.609	0.581	0.556
Isoleucine	688	%	0.655	0.625	0.598
Dig. Isoleucine	585	%	0.557	0.531	0.508
Sodium	160	%	0.152	0.145	0.139
Potassium	500	%	0.476	0.455	0.435
Chloride minimum	160	%	0.152	0.145	0.139
Chloride maximum	310	%	0.295	0.282	0.270
Linoleic acid	155	%	1.476	1.409	1.348

* The energy needs are calculated for a body weight of 1660 g. Every 50 g of change will have an impact of +/- 4 kcal / bird / day



Table 15: Ca and P needs during laying period

	Before peak	Peak to 45 weeks	45 – 70 weeks	> 70 weeks
Ca (g/bird/day)	3.80	4.00	4.30	4.50
Phosphorus* (mg/bird/day)	600	540	480	430
Av. Phosphorus (mg/bird/day)	420	380	340	300
Dig. Phosphorus (mg/bird/day)	360	325	290	255

Levels can be changed based on the use and the levels of phytase

Table 16: Vitamin and trace mineral recommendation in Lay

		Lay
Vitamin A*	IU	10000
Vitamin D ₃	IU	2500
Vitamin E	IU	75 – 100
Vitamin K ₃	mg	3**
Vitamin B ₁	mg	1
Vitamin B ₂	mg	10
Vitamin B ₆	mg	6
Vitamin B ₁₂	mcg	30
Pantothenic acid	mg	20
Nicotinic acid	mg	50
Folic acid	mg	2
Vitamin C	mg	150
Biotin	mcg	200
Cholin	mg	400
Cocciostat		–
Manganese***	mg	70
Zinc***	mg	60
Iron	mg	35
Copper***	mg	10
Iodine	mg	0.5
Selenium***	mg	0.3

* Higher level might be possible according to local state and national regulations.

** double in case of heat treated feed

*** levels of organic trace minerals

Table 17: Addition of Coarse calcium at farm in the afternoon

Week	Grams
18 – 25	1.0
26 – 45	2.0
46 – 70	3.5
> 70	4.0

*Review the formulation to balance it in Calcium

Table 18: Particle size distribution recommendation in layer feed

Week	Fine*	Coarse**
18 – 25	35 %	65 %
26 – 45	30 %	70 %
46 – 70	25 %	75 %
> 70	15 %	85 %

*Fine Limestone: average 1 mm

**Coarse Limestone:
85 % of the particles > 3.5 mm and less than 5 % < 5 mm

Table 19: Ideal protein ratio in layer hens

	Lay
Lysine	100 %
Methionine	50 %
Met. + Cys.	92 %
Threonine	70 %
Tryptophan	24 %
Ile	80 %
Valine	88 %
Arginine	104%

FEED STRUCTURE

Mash feed is the most commonly used feed throughout the world. Layer hens tend to eat the larger particles avoiding the fine particles which is where most of the key nutrients are. Therefore, it is vital for successful nutrition to have a uniform particle structure. It is even more important in non-beak treated birds.

Table 20: Pullet feed particle size

Pullets	Media %
> 2 mm	28.2
> 1.4 < 2 mm	24.5
> 1 < 1.4 mm	12.8
> 0.71 < 1 mm	9.9
> 0.5 < 0.71 mm	8.8
< 0.5 mm	15.6

Crumble and pellet forms can be used as long as the structure holds in the feeding system of the birds and it doesn't become a fine particle mash.

Table 21: Layer feed particle size

Layer	Media %
> 2 mm	26.2
> 1.4 < 2 mm	30.3
> 1 < 1.4 mm	14.4
> 0.71 < 1 mm	9.0
> 0.5 < 0.71 mm	7.1
< 0.5 mm	12.6

Key points of the uniformity in mash diets

- Grinding of the raw materials
- Particle size of the protein sources
- Addition of liquids like oil that reduces the dustiness of feed
- Reduction of fine particle raw materials
- A good feed structure is even more important with non beak treated birds.
- See table 20 and 21 for feed particle size in pullet and layer feeds.



FEED QUALITY

Nutrients

Good information is needed to formulate a realistic diet. A combination of available literature, wet chemistry methods and/or NIR is necessary to generate an updated matrix of the raw materials we use.

Microbiology

There are no specific guidelines in place, however the lower the contamination, the better the performance parameters. Ensure adequate control measures are in place to prevent microbiological risk factors in the

diet. Extremely important is the prevention of SALMONELLA; stronger control measures than laying hens.

Oxidation

Oils in the feed mill and fat in the diet are the commonest components of oxidation. The quality control plan of raw materials should include analysis of the oxidation status of oils, evaluating at least two parameters of the available methods.

Mycotoxins

Follow the guidelines available in your country and literature to prevent negative effects on layer hen health and production. Adapt the use of mycotoxin binders to suit the level of risk in the diet and the contamination load in the raw materials.

Antinutritional factor

Good understanding of the ANF will allow higher or lower inclusion levels of the raw materials.

KEY POINTS

- ▶ Adjust the feed to the needs of the birds based on the body weight and egg mass produced.
- ▶ Calcium and phosphorus requirements change as the layer hen gets older.
- ▶ Excess and deficiencies have a negative effect in egg shell quality.
- ▶ Feed structure should be attractive for the layer hens, so they eat a complete diet.
- ▶ Thorough information of nutrient and microbiological quality is key for a good performance.



HOUSE ENVIRONMENT

- ▶ How to control the effect of temperature on the birds.
- ▶ How to provide good quality water to the birds.
- ▶ How to control the effect of the light on the birds.

HEN THERMO-REGULATION

Convection

Heat loss occurs due to the movement of the air which permits the transfer of heat from the hen's body to the air. This process can be promoted by providing fast air movement around the hen.

Conduction

Heat transfer from surface to surface. Normally, it is relatively unimportant as the contact surface is small and the temperature of the litter or of the cage is not significantly different from the body temperature.

Radiation

This is the transmission of heat from a warm object to a cold one. Heat loss is proportional to the temperature difference between the body surface and the surrounding air.

Evaporation

Birds use evaporation to stabilize their body temperature by increasing the respiration rate through panting, which is very effective.

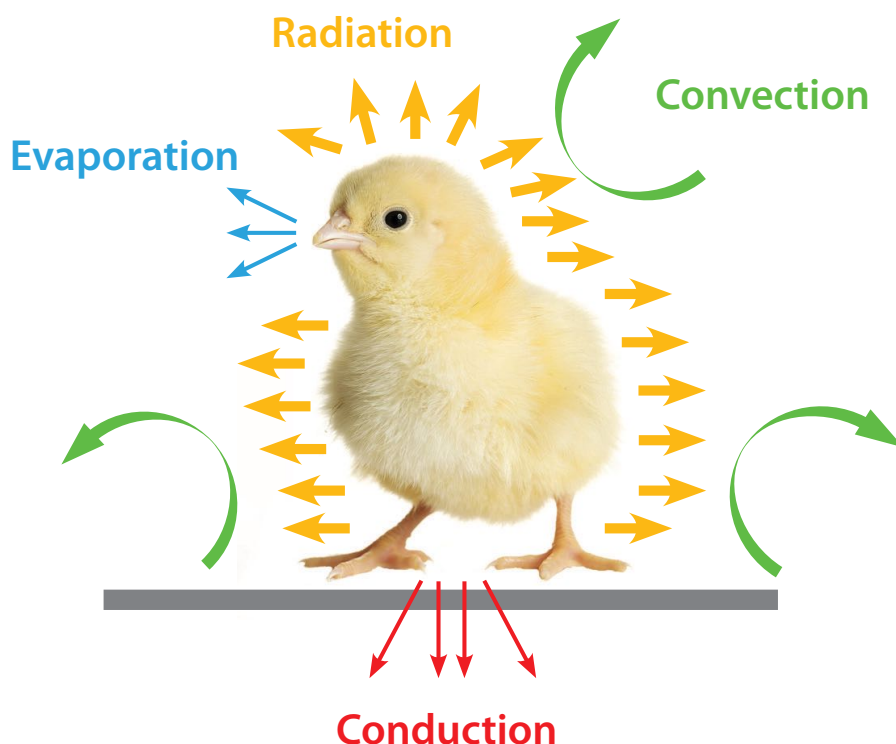

Effect of the room temperature on the different ways of losing heat

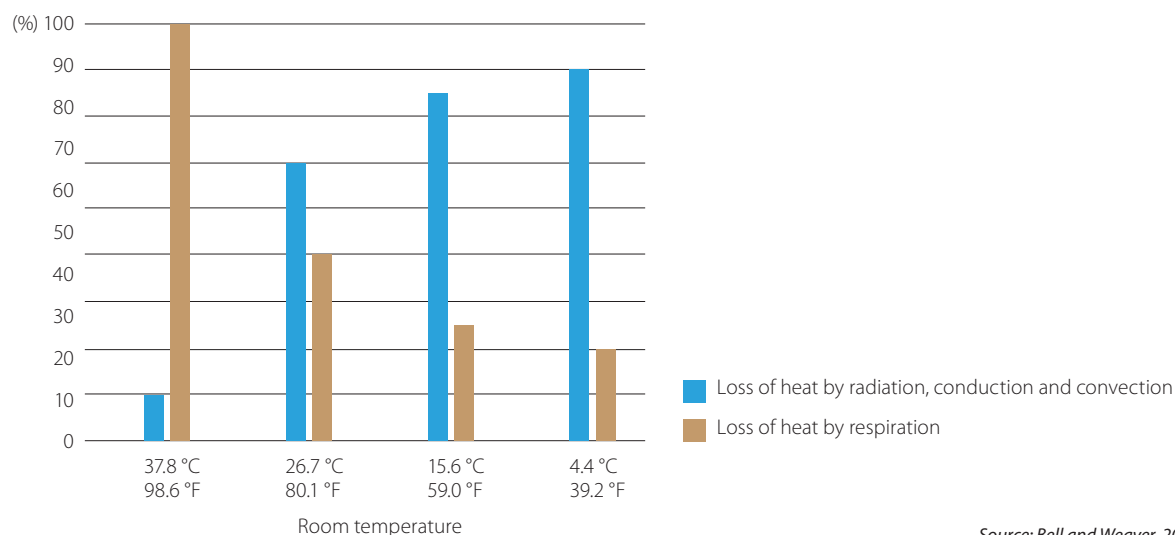

Source: Bell and Weaver, 2002

HOUSE ENVIRONMENT

TEMPERATURE

The ambient temperature has a great influence on egg production. Layers perform well over a wide range of temperatures. Temperature fluctuations between 21 °C and 27 °C (69.8 °F and 80.6 °F) have a minimal effect on egg production, egg size and shell quality. Feed conversion improves with higher house temperatures, and maximum efficiency is attained in the 21 – 27 °C (69.8 – 80.6 °F) range. As the temperature rises, however, the following parameters could be affected:

- Feed intake
- Egg weight
- Egg production
- Eggshell quality
- Mortality

A uniform temperature throughout the house is very important. Good ventilation management and thermal insulation should help to reduce or eliminate temperature variations, specially between day and night.

The temperature should not be seen as an isolated parameter but always considered in combination with humidity. In addition, air speed is also an important element of the perceived ambient temperature.

Tabel 22: Temperature and its effect on the birds

Temperature		Effects
°C	°F	
< 20 °C	< 51.8 °F	Increased feed conversion
20–27 °C	51.8–77 °F	Ideal temperature for good performance and feed conversion.
27–31 °C	77–87.8 °F	Slightly reduced feed intake. Slightly impact on fertility.
32–36 °C	89.6–96.8 °F	Further reduction of feed intake. Reduced activity and drop in egg production, egg weight, shell quality and fertility.
37–39 °C	98.6–102.2 °F	Severe reduction of feed intake. Increase in cracked eggs. Mortality of heavier hens or those in full production.
40–42 °C	104–107.6 °F	Severe panting and respiratory alkalosis. Increased mortality due to heat prostration.
> 42 °C	> 107.6 °F	Emergency measures are needed to cool down hens for survival.

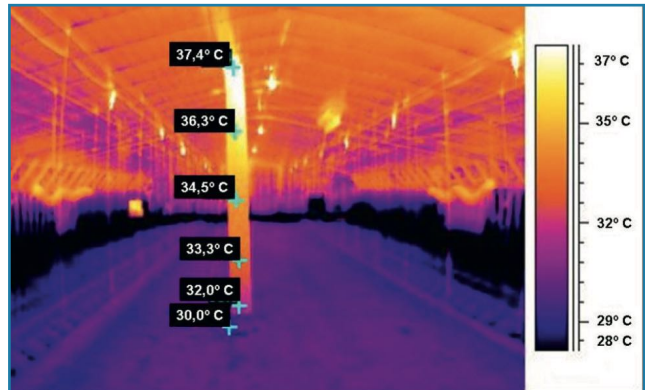

Temperature always has a height gradient. Careful consideration should be taken in cage systems. Courtesy of M. Czarick – UGA

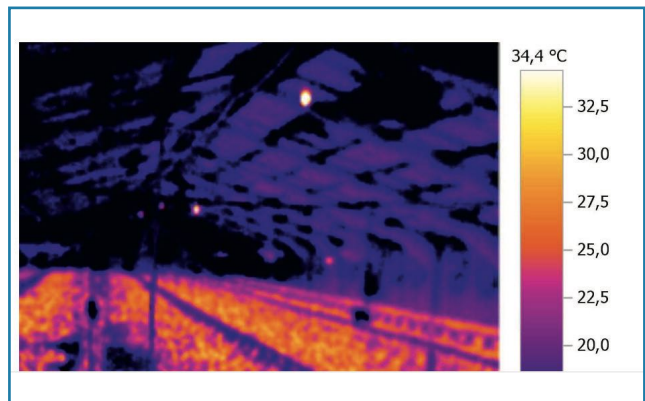

Roof insulation is the corner stone for a correct house temperature and ventilation in hot or cold weather.

Courtesy of M. Czarick – UGA

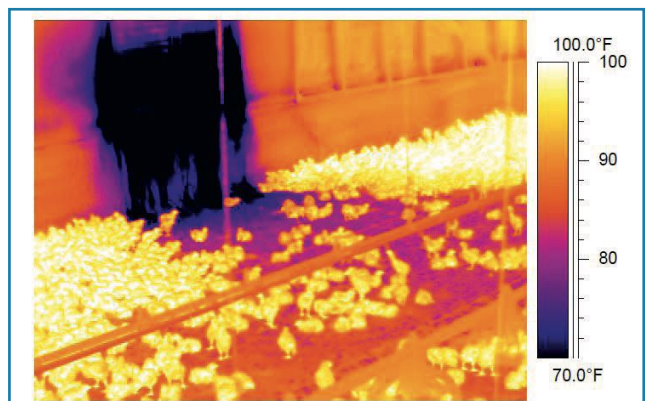

Fans or windows don't have the same insulation capacity as the walls. They can create uncomfortable areas for the birds.

Courtesy of M. Czarick – UGA



HOUSE ENVIRONMENT

HOT CLIMATE

High temperatures, especially over a long period, can cause serious losses to the poultry farmer. The effects of heat stress are delayed onset of lay, lower performance, decreased feed intake, increased mortality and drop in the fertility. Therefore, to minimize financial losses, every effort should be made to maintain an ambient temperature in the house that is within the bird's comfort zone. If this is not possible, corrective measure should be taken:

Ventilation

The ventilation system should be checked before the hot weather arrives. Fans should be cleaned and fan belts should be tightened and replaced if necessary. The inlets must be adequate to supply the air flow needed, they should be clean and not obstruct the flow of the incoming air. Tunnel ventilation and cooling pads are the preferred ventilation system.

Low stocking density

The stocking density should be in accordance with the environmental conditions. If the housing density is too high, the radiant heat between the birds will accumulate, the temperature will increase and air will be prevented from circulating around the birds properly. They should be enough space for the birds to separate in order to pant and droop and slightly lift their wings away from the body to maximize responsible heat loss.

Cold and good quality water

When birds are heat stressed, they increase consumption of water in an effort to cool down. The ratio of water to feed increases from 2:1 under normal conditions to over 5:1 under hot conditions. Cool water of good quality should be supplied so that birds can find relief from the heat. To ensure that all the birds have access to water, provide the minimum of water space and adjust it according to the climate conditions.

During period of hot temperature, the drinker lines should be flushed every day and at least one time per day at the start of lighting program, to get fresh water into the system.

Feeding times

Do not feed at the hottest time of the day. A good strategy is to withhold feed five to eight hours prior to the anticipated time of peak temperature. Feeder chains should be run frequently to stimulate feed intake. The feeder should remain empty for about two hours per day in the afternoon, to promote a better appetite and ensure that the fine particles are consumed, which usually consist of minerals, vitamins and amino acids. To increase feed consumption, a midnight snack can be implemented.

Feed formulation

Since feed intake is reduced during hot weather periods, the general feeding approach is to increase the energy content in the feed to keep daily energy intake at the level necessary for optimum performance under these conditions.

Hatching egg collection

High temperatures require to collect the eggs more frequently to minimize incubation conditions inside the nests.

- ▶ Check the [Hot Climate Management Guide](#)

Shades in open houses



Fans

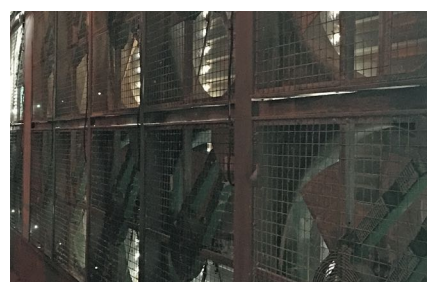

Inlets



Water reservoir



HOUSE ENVIRONMENT

WATER QUALITY

Water is the most important and critical nutrient for hens. Any water privation will directly impact feed consumption and production. If privation exceed 24 hours, egg production will be severely affected. If privation exceed 48 hours, high mortality will occur in the flock. It is therefore essential to provide a good quality, stable and reliable source of water. Better still, ensure there are two water sources.

Microbiological quality

Water can act as a disease carrier if it is contaminated at the source. Moreover, a poor microbiological quality of water can affect gut health and lead to pathologic issues that affect production.

The microbiological quality at the water source should be monitored and samples should be taken at least once per year. This is even more important if water comes from surface sources.

Even if the water source is of excellent quality, chlorination or an alternative treatment is highly recommended. Treatment of surface water is compulsory.

Physical quality

The content of minerals and other elements can greatly impact egg production and hen health. Even if corrective measures can be taken, it is very difficult and expensive to alter the chemical characteristics of water. A good quality water source is a huge advantage when a new farm is under construction. The physical and chemical water quality must be monitored and samples taken at least every year.

Refusing water

In some cases, hens can refuse water. This situation is the same as water privation:

- **Temperature:** hens will decrease their water consumption when water is above 24° C, but will refuse it above 32 °C
- **Taste:** hens do not have a very developed sense of taste but will refuse to drink water with a unpleasant taste. Some water additives or antibiotics can produce this effect.

- ▶ **Always when you apply a product through the water lines must check that the water flow isn't impaired**

Tabel 23: Drinking water parameters

Element	Maximum Limit
No. of Bacteria per ml	10 – 50
No. of Coli forms per ml	0
Organic Substances	1 mg / litre
Nitrates	0 – 15 mg / litre
Ammonia	0 mg / litre
Cloudiness / Turbidity	5 U
Iron	0.3 mg / litre
Manganese	0.1 mg / litre
Copper	1.0 mg / litre
Zinc	5 mg / litre
Calcium	75 mg / litre
Magnesium	50 mg / litre
Sulphates	200 mg / litre
Chlorides	200 mg / litre
PH value	6.8 – 7.5

Water consumed / 1000 birds / day

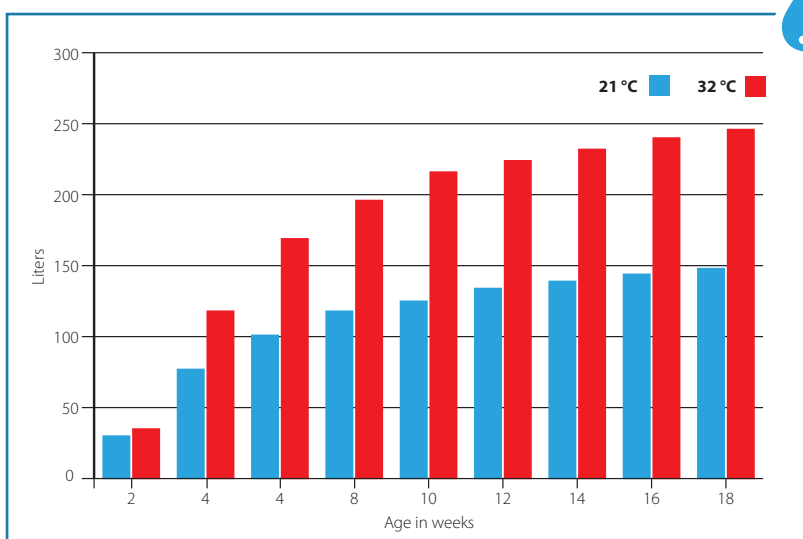

Water chlorination station





HOUSE ENVIRONMENT

AIR QUALITY

Good air quality should be guaranteed in the house by using proper ventilation, so there is a low concentration of gases and dust. At the same time, the temperature in the house should be optimally maintained between 18 – 20 °C with a relative humidity of 50 – 60 %.

The rate of ventilation is determined by the temperature, however when this parameter is reached a minimum ventilation level must be guaranteed. This minimum is normally calculated in m³/body weight/hour but the real aim is the correct management of these parameters:

- Relative humidity
- CO₂ > 5000 ppm
- CO > 50 ppm
- NH₃ > 25 ppm

Table 24: Air Movement

Weeks of age	Ambient Temperature					
	32	21	10	0	-12	-13
1	360	180	130	75	75	75
3	540	270	180	136	110	110
6	1250	630	420	289	210	210
12	3000	1500	800	540	400	400
18	7140	3050	2240	1500	600	600
19+	9340-12000	5100-6800	3060-4250	1020-1700	700-1050	700-850

m³/hour/1000 birds

VENTILATION SYSTEMS FOR LAYER BREEDER

Transverse Ventilation

1. Most commonly used during brooding or in cold weather.
2. Cold air is directed to the roof. Air circuit is very important for avoiding cold draft at the bird's level.
3. Normally it is not working in permanence but it is driven by a timer.

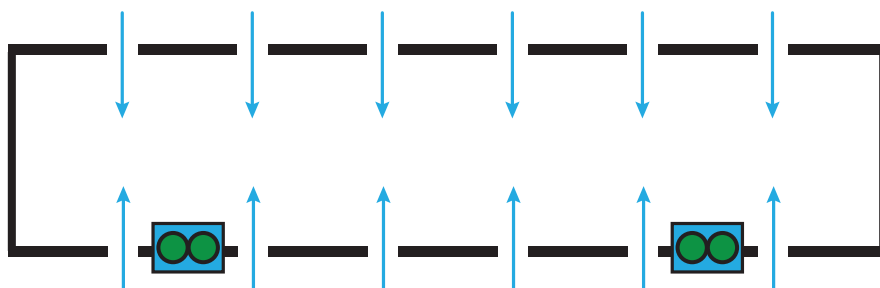

Transition System

1. Used when temperature rise but tunnel ventilation cannot be used. (Not available, cold weather, young chicks)
2. Air still is directed to the roof.
3. Main function is to reduce the house temperature.

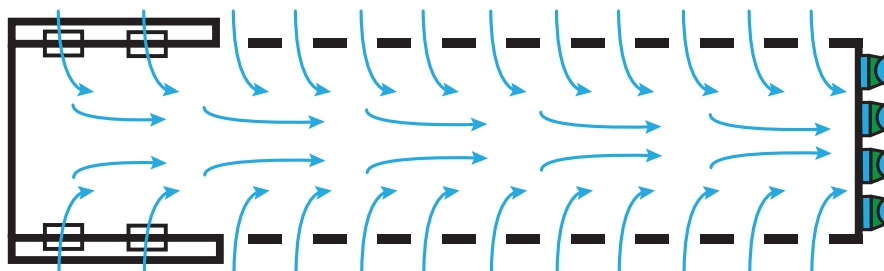

Tunnel System

1. Used in hot weathers and only in adult feathered birds.
2. It generates a high-speed flow at bird's level. It helps to cool the birds by the wind chill effect
3. Most important driver for this system is the air velocity at bird's level

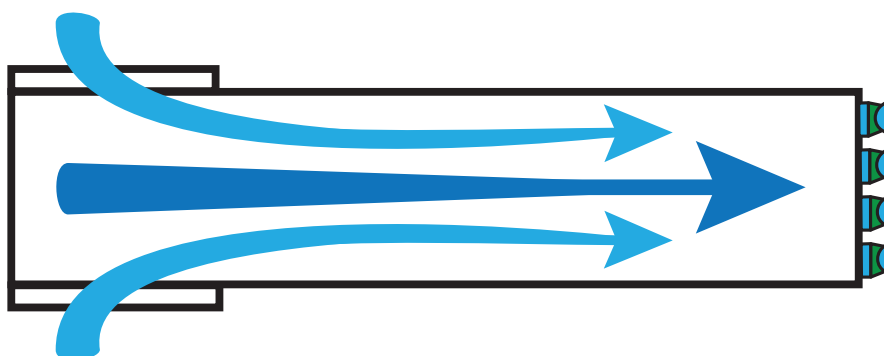

HOUSE ENVIRONMENT

LIGHT

Birds vision differs from that of humans in vision spectra. Hens can see ultraviolet and infrared light. This fact should be considered

when creating light programs and the light color choice.

strobe light effect on hens and encourage feather pecking and cannibalism.

Hens need proper light with an adequate light intensity and the correct photoperiod. The best source of light for production is a high frequency (> 2,000Hz) bulb emitting light within the warm color spectrum (2,500–3,500 K). Low frequency fluorescent tubes or energy saving bulbs (50–100 Hz) have a

In addition, hens can see perfectly in a low light intensity ambiance. Light intensity will vary during the different production stages but keep in mind that the higher the light intensity, the more active the hens will be. It can be positive (as in the case of brooding) or negative (as in the case of cannibalism during laying). In any case, light intensity variation during the day should be avoided as it can cause high stress level in the hens. Direct sunlight should also be avoided for the same reason.

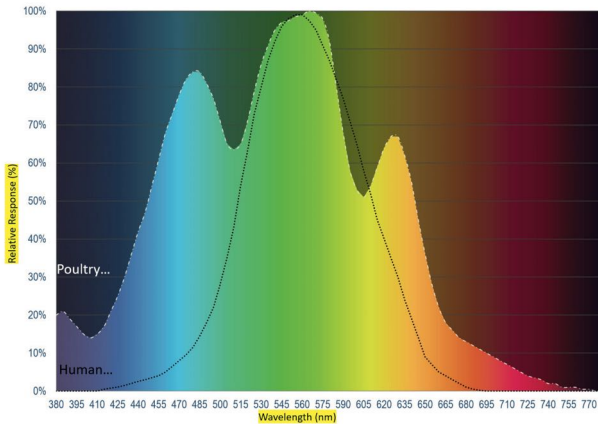

LIGHT INTENSITY IN PRODUCTION FLOOR HOUSE

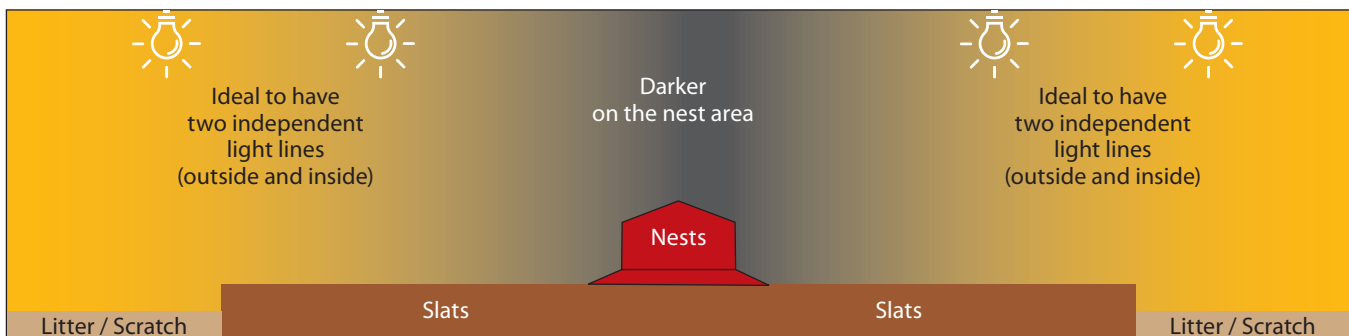

KEY POINTS

- ▶ Temperature has a critical impact and must be well managed to achieve good production.
- ▶ In warm weather, take corrective measures to reduce the impact of temperature.
- ▶ Water is a key nutrient. Ensure that a good quality water supply is accessible to the hens.
- ▶ Maintain good air quality and distribution through correct ventilation.
- ▶ Remember that light impacts significantly on hen behavior.



BIRD ASSESSMENT

► How to get reliable information to make good decisions.



PULLET PHASE

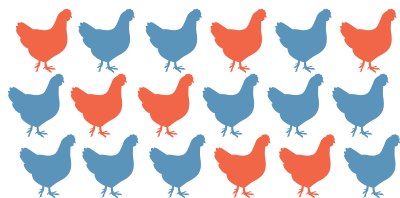

BODY WEIGHT AND UNIFORMITY

Weigh minimum 100 birds

All birds need to be weighed one by one.

Select birds from different areas in the front, middle and back part of the house. In case of family cages, select cages from different tiers and also from the front, middle and back part of the house. All the birds of the selected cage need to be weighed and weigh the same cages every week and very week, weigh the same cages.

Weigh weekly

Formula

UNIFORMITY

$$= \frac{\text{all weighed birds} - A1 - B2}{\text{all weighed birds}}$$

A1 =

No. of birds \geq average BW x 1.1

B2 =

No. of birds \leq average BW x 0.9

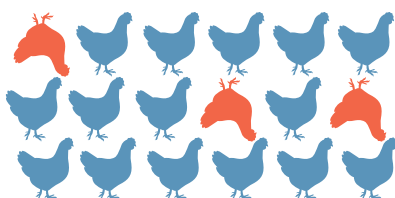

MORTALITY

Daily Mortality (%)

$$= \frac{\text{No. of dead birds today} \times 100}{\text{No. of live birds yesterday}}$$

Weekly Mortality (%)

$$= \frac{\text{No. of dead birds in last 7 days} \times 100}{\text{No. of live birds on day before the week starts}}$$

Accumulated Mortality (%)

$$= \frac{\text{No. of dead birds so far} \times 100}{\text{initial No. of housed birds}}$$

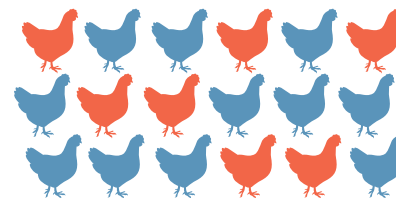

SHANK LENGTH OR KEEL LENGTH

Measure minimum 50 birds

Select birds (males and females) from different areas and the front, middle and back part of the house. All the birds of the selected cage or area need to be measured.

Measure 5th week before transfer

How to do shank measurements



How to do keel measurements





PRODUCTION PHASE

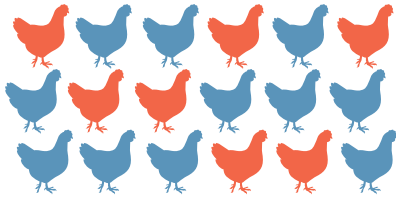

MALE EVALUATION

Measure minimum of 5 % of the males

Select birds from different areas and the front, middle and back part of the house.

In case of family cages, select cages from different tiers and also from the front, middle and back part of the house.

Males selection at 10 weeks of age and a week before transfer and/or light stimulation

Check for

Excellent feather cover

Good legs

Good body condition

Cull all the submissive males: small, bad plumage, lesions on the head, etc.

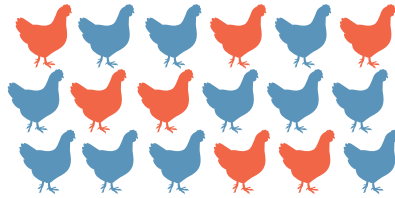

BODY WEIGHT AND UNIFORMITY

Weigh minimum 100 males and 100 females

All birds need to be weighed one by one.

Select birds from different areas and the front, middle and back part of the house. In case of family cages, select cages from different tiers and also from the front, middle and back part of the house. All the birds of the selected cage need to be weighed and weigh the same cages every week and very week, weigh the same cages.

Frequency

Weigh weekly up to 30 weeks of age

Weigh every 2 weeks up to 40 weeks of age

Weigh monthly after 40 weeks of age

Formula

UNIFORMITY

=

$$\frac{\text{all weighed birds} - A1 - B2}{\text{all weighed birds}}$$

A1 =

No. of birds \geq average BW x 1.1

B2 =

No. of birds \leq average BW x 0.9

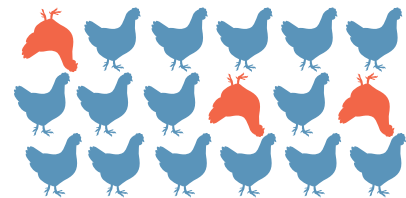

MORTALITY

Daily Mortality (%)

=

$$\frac{\text{No. of dead birds today} \times 100}{\text{No. of live birds yesterday}}$$

Weekly Mortality (%)

=

$$\frac{\text{No. of dead birds in last 7 days} \times 100}{\text{No. of live birds on day before the week starts}}$$

Accumulated Mortality (%)

=

$$\frac{\text{No. of dead birds so far} \times 100}{\text{initial No. of housed birds}}$$



PRODUCTION PHASE

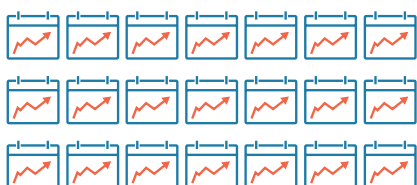

EFFICIENCY PARAMETERS

Weekly females produced per hen housed

$$= \frac{\text{No. of female chicks produced within 7 days}}{\text{No. of hens housed after transfer to production house}}$$

Females produced per hen housed

$$= \frac{\text{No. of female chicks produced}}{\text{No. of hens housed after transfer to production house}}$$

Eggs per hen housed

$$= \frac{\text{No. of eggs produced}}{\text{No. of hens in the production house after transfer}}$$

Hatchable eggs per hen housed

$$= \frac{\text{No. of hatchable eggs}}{\text{No. of hens housed in production after transfer}}$$

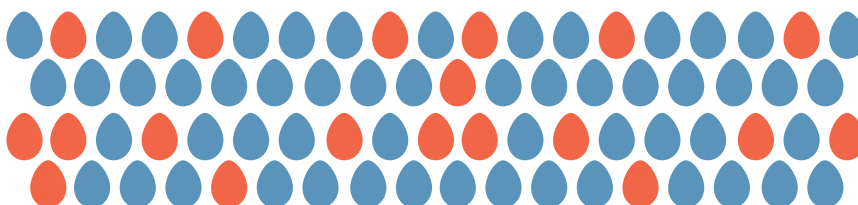

EGG PRODUCTION

Daily Laying Rate (%)

$$= \frac{\text{all produced eggs} \times 100}{\text{daily birds in the farm}}$$

Accumulated Lay (%)

$$= \frac{\text{Sum of all the produced eggs}}{\text{No. of birds housed} \times \text{Days in production}}$$

Daily egg size

$$= \frac{\text{Total weight of produced eggs}}{\text{Total No. of produced eggs}}$$

Weekly egg size

$$= \text{Average egg size of the last 7 days}$$

Downgrades

1. No. of broken eggs (BE)
2. No. of cracked eggs (FE)
3. No. of dirty eggs (DE)

Daily Downgrade (%)

$$= \frac{\text{Sum of daily BE, FE, DE} \times 100}{\text{all the daily eggs}}$$

Accumulated Downgrade

$$= \frac{\text{No. of all BE, FE, DE so far} \times 100}{\text{all eggs so far}}$$

HEALTH AND BIOSECURITY

- ▶ Understanding the importance of health programs in modern egg production.
- ▶ How to implement a biosecurity program.
- ▶ How to implement and monitor a vaccination program.

FLOCK HEALTH AT PARENT STOCK FARM: A CRITICAL POINT FOR SUCCESS

In the egg industry, numerous diseases are vertically transmitted, this means from breeders to their progeny. That is why without a strict sanitary control at the selection and reproduction level it is not possible to control these diseases in commercial layer. This will avoid the birds express their maximum genetic potential.

The control strategy should always be to keep the flocks free of these diseases and

monitor that their status remains so over time. If the birds are infected by vertical transmitted diseases, antibiotic use or other treatments can help to recover the productivity of the birds, but in no case, will ensure the non-transmission of these diseases to the progeny. That is why these strategies are wrong and should be not implemented.

In the other hand, layer breeder should transmit maternal antibodies to the day-old

chick for conferring protection against certain diseases. Otherwise the chick will suffer from these diseases if they are challenged by during the first days of life. That is why it is so important to adapt the vaccines program for assuring that these antibodies are developed by breeder.

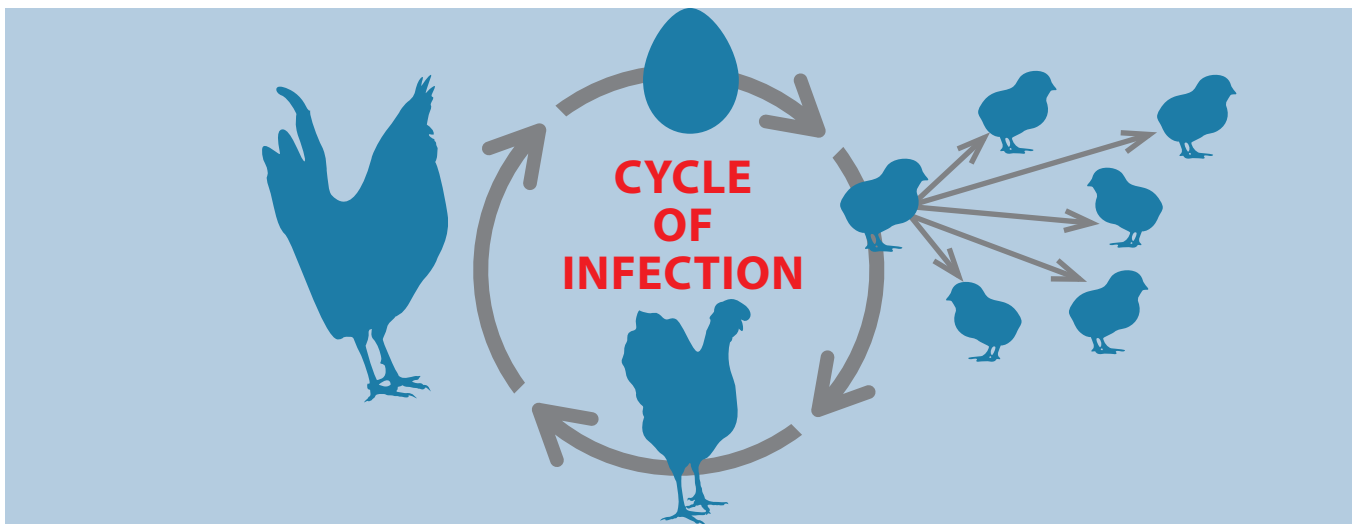

POSSIBLE INFECTION ROUTES

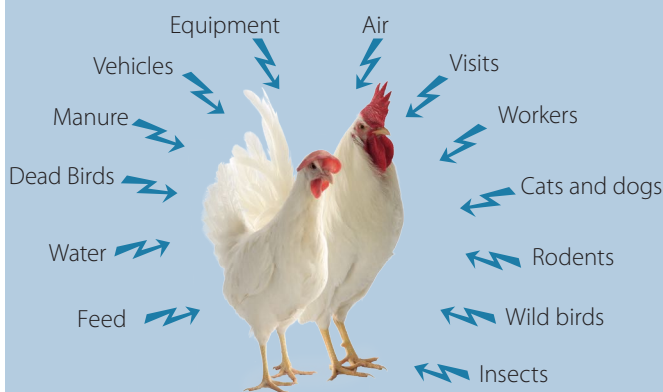

Major vertically transmitted diseases

- Mycoplasma gallisepticum
- Mycoplasma sinoviae
- Salmonella spp.
- Avian Leukosis virus

Diseases in which maternal antibodies play a key role in protection

- Chicken Anemia Virus
- Avian encephalomyelitis
- Gumboro disease



HEALTH AND BIOSECURITY

BIOSECURITY PROGRAM

A biosecurity program plays a key role in maintaining hens in good health and, therefore, profitable production. Biosecurity can be defined as all the procedures put in place to prevent pathogens infecting hens and spreading to other poultry farms.

To be effective, a biosecurity program

should be implemented in a very practical and structured way. An effective biosecurity program is well-adapted to the production structures and well-understood by all the actors (staff, production managers, external suppliers, veterinarians, general manager etc.) at the farm. If certain actors do not take

biosecurity seriously and fail to follow the procedures, the efforts of the others will not be rewarded.

It is essential to apply procedures systematically. Sporadic application of a biosecurity program will not work.

BIOSECURITY TYPES

Conceptual biosecurity

- ▶ This is the biosecurity related to the farm design and its location of the farm and its surroundings.

Ideally farms should be situated away from:

- other poultry farms (including backyard farms)
- other farms (other species)
- Live bird markets
- Hatcheries
- Slaughterhouses

If these kind of facilities are near to the farm, structural and operational biosecurity should be improved. If possible, new farms should be constructed in biosecure locations.

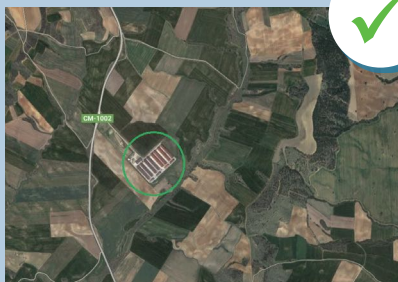

Isolated location



High-density farm location

Structural biosecurity

- ▶ This is the biosecurity related to the physical structures used at the farm to prevent the introduction or spread of diseases.

Important components include:

- Perimeter fences
- Surrounding buffer zone
- Bird-proof elements
- Entrance doors
- Disinfectant system in entrance door
- Shower or black/white room
- Booth baths
- Work clothing and footwear
- Feed storehouse or silos
- Dead bird disposal



Sink



Surrounding concrete zone

Operational biosecurity

- ▶ This is the biosecurity related to how work on the farm should be done to prevent the introduction or spread of diseases.

People are the key element to success here. Good communication, which implies training, is essential to improve operational biosecurity.

Clear and written biosecurity protocol should be available for all the staff having contact with the farms. Normally the simplest rules work better than the complicated.

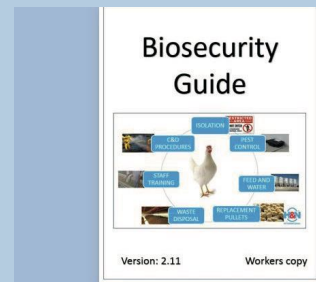

Written biosecurity protocol



Farm meeting room



BIOSECURITY PROGRAM – STEP 2

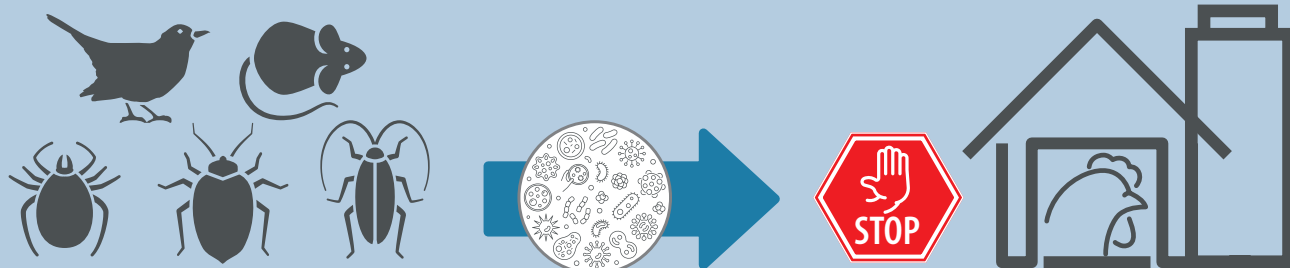

PEST CONTROL

► This includes all measures taken to prevent the introduction and spread of pathogens by vermin (esp. rodents and birds) and insects.

Rodents

The flock health status will be severely damaged in the event of infestations of rats or mice.

Passive measures:

- Keep the perimeter around the house free of grass and other organic material.
- Maintain integrity of walls.
- Keep feed free of rodents.
- Remove any spilled feed.

Active measures:

- Install bait stations.
- Have an active Rodent Control Program.

Birds

It is very important to exclude other birds from entering hen houses. Bird-proof houses can be constructed using special netting. Bird's feces are also very infectious material. Direct or indirect contact should be completely avoided.

Insects and other

Establish an insecticide program. Manure management is also very important to prevent flies. Mites can be very damaging to the hens overall health status. This is particularly the case with Red Mite and Northern Fowl Mite. See its control in the Technical Tips.

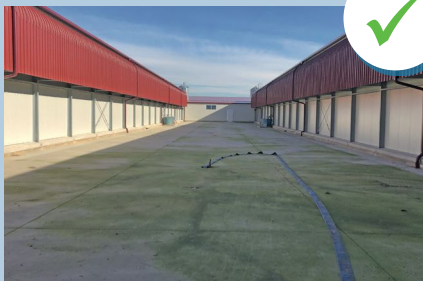

BIOSECURITY PROGRAM – STEP 3

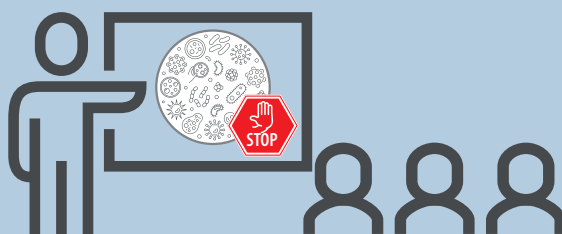

STAFF TRAINING

► This includes all measures related to training workers to do their jobs properly and observe biosecurity regulations.

Information, meetings and training days should be provided to staff and other people working on the farm to ensure that they

understand, respect and collaborate in the biosecurity program. It is also very important to ensure staff do

not raise poultry at home or come into contact with other birds (pigeons, hawks, ducks, ...).

HEALTH AND BIOSECURITY

BIOSECURITY PROGRAM – STEP 4

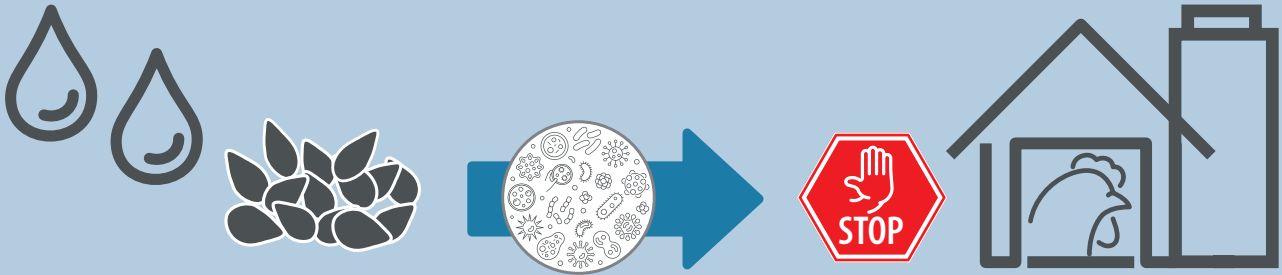

FEED AND WATER

► This includes all measures taken to avoid the introduction and spread of pathogens by water and feed.

Feed

The quality of raw materials and hygiene measures at the feed mill are vital to produce pathogen-free feed.

Adding disinfectants is also recommended. Feed transport and feed storage should be controlled to avoid contamination after feed mill delivery.

Water

Chlorine or an alternative disinfectant should be added to drinking water. It has a dual purpose: firstly preventing the introduction of pathogens by water and secondly reducing water recontamination while it is in the house pipeline.

See page 67 for more information on water quality.



Silos in good conditions



BIOSECURITY PROGRAM – STEP 5

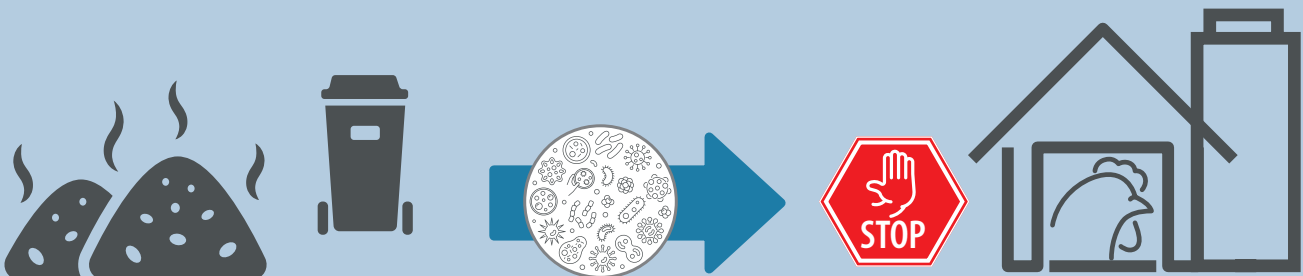

WASTE DISPOSAL

► This includes all measures to prevent the introduction of pathogens during waste removal.

Waste removal and disposal is critical because waste material can be heavily contaminated.

Manure

Manure should be removed and disposed of at least 3 km away from the site. Make sure that no other farms dispose of their manure within a 3 km radius of your farm.

Dead birds

Dead birds should be removed from hous-

es on a daily basis and stored away from the poultry houses.

Different methods are available to destroy the dead birds hygienically. If dead birds are moved from the farm, take extreme care during transport:

- Never permit transport of dead birds to enter the farm.
- Only permit dead birds to be collected outside the farm.
- Never have personal contact with people handling dead birds.



Dead birds container





BIOSECURITY PROGRAM – STEP 6

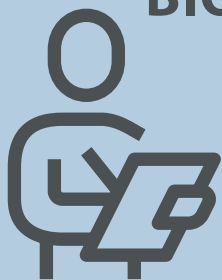

CLEANING & DISINFECTION PROTOCOL

► This includes all measures to prevent pathogens being transferred from one flock to the following.

If a severe infestation of mites or other parasites has occurred, take extra precautionary measures to eliminate or exclude the presence of pests. See the disinfectant table for more details.

Table 25: Common disinfectants used in farms

Chemical disinfectant	Mycoplasma	Gram + Bacteria	Gram – Bacteria	Enveloped virus	Non-enveloped virus	Fungal spores	Coccidia	Characteristic
Aldehydes	++	++	++	++	++	+	-	Efficacy reduced by organic material, soap and hard water. Irritative
Alkalis	++	+	+	+	+–	+	+	Corrosive, irritative
Biguanides	++	++	++	+–	-	-	-	Ph dependent, inactivated by soaps
Chlorine Compounds	++	++	+	+	+–	+	-	Inactivated by sunlight and soap, corrosive, irritative
Oxidant agents	++	+	+	+	+–	+–	-	Corrosive
Phenolic Compounds	++	+	++	+–	-	+	+–	Irritative
Quaternary Ammonium Compounds	+	+	+	+–	-	+–	-	Inactivated by organic material, soap and hard water

BIOSECURITY PROGRAM – STEP 7



PULLET REPLACEMENT

► This includes all measures to prevent the introduction of vertically transmitted pathogens.

In order to achieve this, the breeder flock should remain disease-free. Sampling and analysis should be encouraged to check that one-day old chicks are not contaminated. H&N grandparent stock are free of lym-

phoid leukosis, Mycoplasma gallisepticum, Mycoplasma synoviae, Salmonella pullorum, Salmonella gallinarum, Salmonella enteritidis, Salmonella thyphimurium and other Salmonella species.

Take into account that trucks and other equipment can be infected with pathogens or infested with parasites. Previous cleaning and disinfection of all of them is strongly recommended.

HEALTH AND BIOSECURITY

VACCINATION PROGRAMS

Specific recommendations for individual farms are not possible, but the sample vaccination program (table 26) is intended as a very general guideline for vaccinations which are needed on most farms worldwide.

Additional vaccinations for coccidiosis, Escherichia coli, Avian Influenza and the variant strains of other disease-causing agents may also be needed. These decisions, however, need to be made on a farm-by-farm basis after careful consideration of the risk factors involved which

include, but are not limited to: previous exposure, geographic location, vaccination and exposure of neighboring flocks, state regulations and endemic disease-causing factors.

Ask for an adapted vaccine program from your local veterinarian

Table 26: Vaccination program

Weeks	Marek's disease	Infectious Bronchitis	Gumboro disease	Gumboro disease (vectored vaccine)	Metapneumovirus Avian	Newcastle disease	Newcastle disease (high challenge)	Newcastle disease (high challenge, vectored vaccine)	EDS 76	Lariongotracheitis (CEO)	Laringoracheitis (vectored vaccine)	Fowl Pox	Encephalomyelitis	Chicken Anemia Virus (web wing administration)	Chicken Anemia Virus	Coccidia*	Coryza	Escherichia coli	Salmonella enteritidis **	
0	1 SC	1 SP		1 SC		1 SP	1 SP 1 IM	1 SP 1 SC			1 SC					1 SP			1 DW	
1																				
2			1 DW			2 SP/ DW	2 SP/ DW	1 SP/ DW												
3			2 DW																	
4		2 SP	3 DW																	
5																				
6						2 SP/ DW	2 SP/ DW	2 SP/ DW										1 IM	1 IM	2 DW
7					1 SP/ DW															
8										1 ED		1 WI	1 WI/ DW							
9		3 SP																		
10						3 SP/ DW	3 SP/ DW	3 SP/ DW												
11														1 WI	1 DW					
12																			3 DW	
13																				
14																	1 IM	1 IM		
15		1 IM	1 IM	1 IM	1 IM	1 IM	1 IM	1 IM												
16																				

SC = Subcutaneous Injection
IM = Intramuscular Injection
ED = Eye Drop

SP = Spray
DW = Drinking Water
WI = Wing Inoculation

Inactivated vaccines Live vaccines Recombinant vaccines

* Flocks housed in floor system. Keep in mind that vaccine should recirculate in the house. ** It could interfere in the monitoring program.



HEALTH AND BIOSECURITY

ADMINISTERING VACCINES IN PRACTICE



Administering the vaccines in practice is just as important as the vaccine program design. All this involves is simply following a

procedure that is clearly defined by the vaccine manufacturer. However, mistakes are still often made. To avoid errors, check and

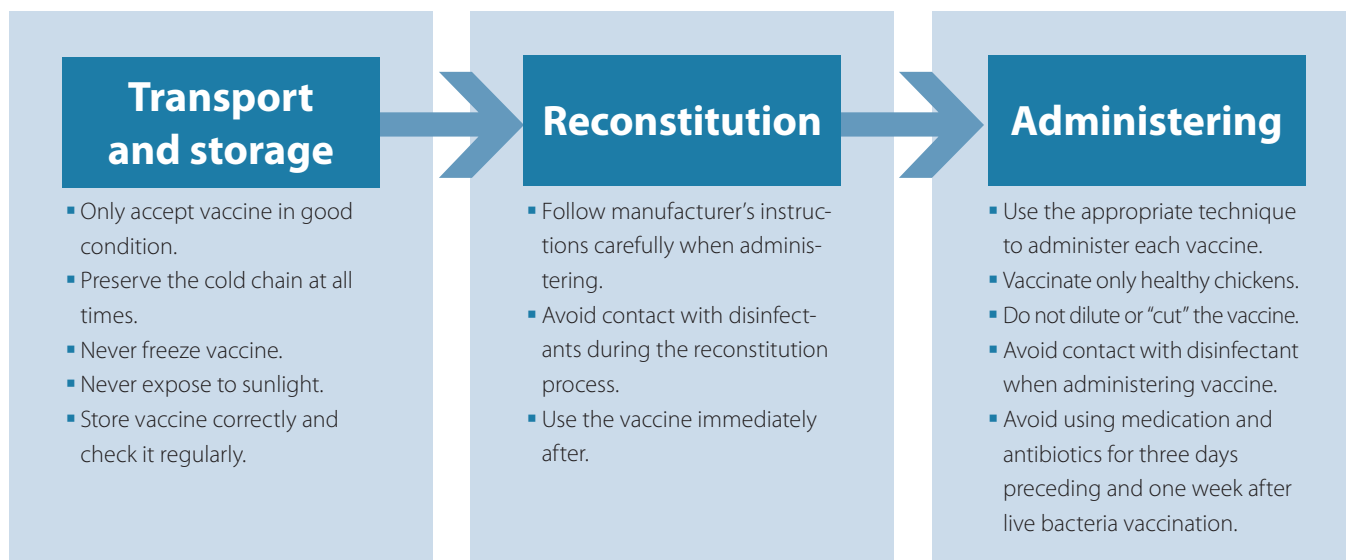
audit these procedures regularly. Proper vaccination is essential for a good health status!



Mass administration



Drinking water

- Most common vaccination technique.
- Assure the absence of chlorine or other disinfectant in the drinking water.
- A previous water privation can assure that all birds are thirsty.
- Use dye in the drinking water for monitoring water consumption.
- Assure that water is consumed within 2 hours.

Spray

- Used for respiratory disease vaccination.
- Assure the absence of chlorine or other disinfectant in the sprayed water.
- Droplet size plays a key role in the vaccine reactions and immune response.
- Distribute vaccine homogeneously among the birds.
- Avoid drafts during the vaccine administration.

Individual administration

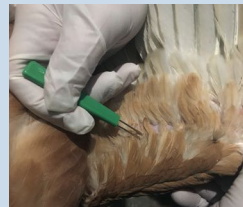
Eye drop

- Used for respiratory disease vaccination.
- Use dye in order to assess the efficiency of instillation.
- Trained and committed crew and a well organized program of work is essential.
- Ensure all chicks are vaccinated.

Injection

- Used for inactivated vaccines and certain live vaccines.
- Injection can be subcutaneous or intramuscular depending on the vaccine.
- Equipment should be correctly maintained.
- Trained and committed crew along with a well organized program of work is essential.

Wing inoculation

- Used mostly for Pox vaccination.
- Assure that needle is in contact with the vaccine before you inoculate every individual bird.
- Trained and committed crew and a well organized program of work is essential.
- Check vaccine reaction 7 days after administering it in the case of Pox vaccine. More than 90 % of chicks should be positive.

HEALTH AND BIOSECURITY

MONITORING PROGRAM

Monitoring programs in breeder is essential to produce high quality day-old chicks. This is because it is the only way to test and verify that the breeding lots are free of vertical transmission diseases. On the other hand, it is necessary to verify that the vaccination programs have been applied correctly and the lot will be protected against productive

problems in case of disease challenge. It is necessary to work in an orderly systematic and organized manner to the full advantages of this program. First of all, it is necessary to have access to a veterinary laboratory that reliably runs the demanded analyzes. Secondly, laboratory results should be read and filed on time by a responsible

veterinarian. In case of nonconformities the adequate corrective measures must be taken. Given the weighty and pressing of these, it is highly recommended to have a contingency plan pre-agreed with the owners of the bird breeders. In many countries, these monitoring programs must conform to the legislation of the country.

Age	Samples	Technique	Analysis
10 weeks	10 x serum	ELISA ARP	MS, MG, IB, TRT, CAV SG
16 weeks	30 x serum	ELISA ARP	MS, MG SG
	10 x serum	ELISA	AI, ND, IB, TRT, CAV, IBD, EDS, AE
22 weeks	30 x serum	ELISA ARP	MS, MG, IB, TRT, CAV SG
	10 x serum	ELISA	AI, EDS, TRT, IBD, AE, ILT, CAV
Every 4 weeks	30 x serum	ELISA ARP	MS, MG SG
	10 x serum	ELISA	AI, ND, IB, TRT, IBD

Age	Samples	Technique	Analysis
10 weeks	2 x 150 gr manure	ISO	Salmonella spp.
16 weeks	2 x 150 gr manure	ISO	Salmonella spp.
22 weeks	2 x 150 gr manure	ISO	Salmonella spp.
Every 4 weeks	2 x 150 gr manure	ISO	Salmonella spp.

KEY POINTS

- ▶ Health is vital to achieve the birds' full genetic potential. Act before diseases become a limiting factor for your performance!
- ▶ Implement a real biosecurity program, not a paper biosecurity program.
- ▶ Adapt the vaccine program to your epidemiological situation.
- ▶ Administer vaccines according to the instructions. No vaccine program will work if vaccines are administered incorrectly.
- ▶ Monitor flock serology to indicate the effectiveness of your vaccination program.
- ▶ Monitor flock serology to check that is free of vertical transmitted diseases.
- ▶ When weekly mortality exceeds 0.1 % / week perform necropsies.



HEALTH AND BIOSECURITY

BREEDING SCHEME

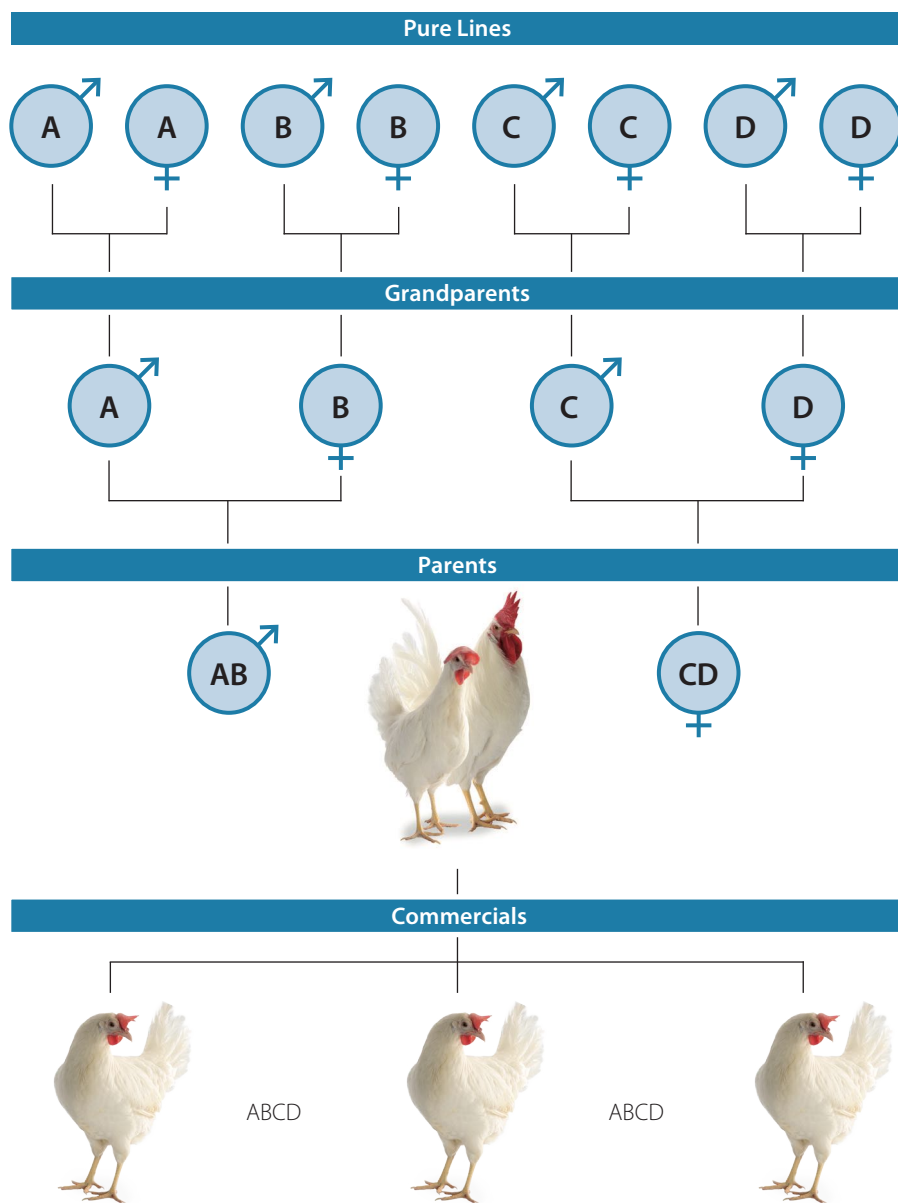

These crosses have been extensively tested and proven to have the best combinability and hybrid vigour to deliver the optimum results at the parent as well as the commercial layer level. It is important that these crosses are done as planned and the right bird is used in the right position. That's why it is important that sexing errors are detected and sorted out as fast as possible.

Several field tests with pedigreed birds are carried out under commercial conditions in different locations worldwide. These data is used to select birds that not only shows a great performance under optimal conditions in the breeding farm but also under commercial conditions, and selecting resilient birds that can cope with different challenges like variable and poor feed quality, hot climate and areas with high disease pressure.

Breeding goals have become more comprehensive including traits such as egg production, reproduction traits, feed efficiency, egg quality traits but additionally these have been complemented in the last decades with other traits related with animal welfare, animal behavior and suitability of birds to cage-free housing systems.

HEALTH AND BIOSECURITY

COMPREHENSIVE BREEDING GOALS – FOCUS IN WIDE-SPREAD GROUP OF TRAITS

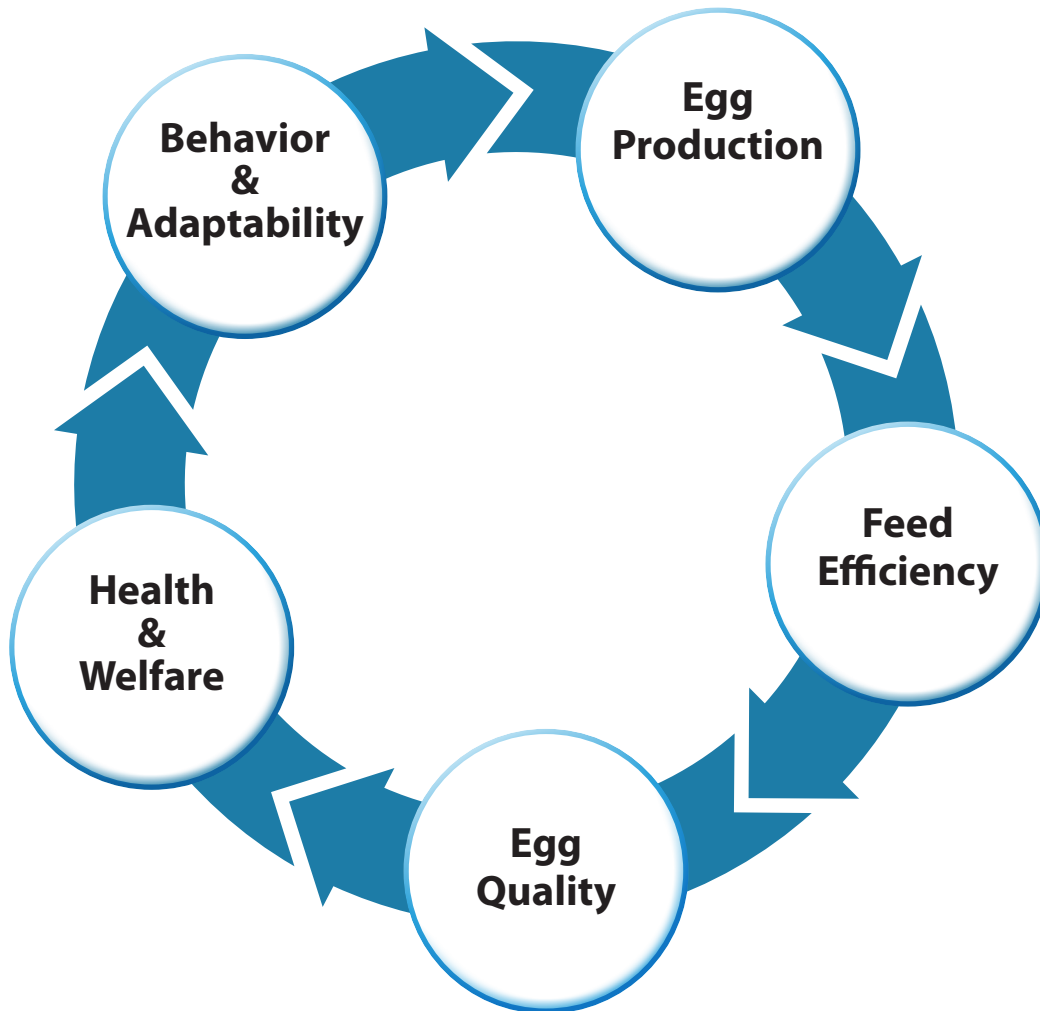

KEY POINTS

- ▶ The increased genetic potentials need to be “translated” into reality in commercial practice. Disease control, farm management and nutrition have to keep pace with genetic improvement.



PERFORMANCE GOALS

Table 27: Production performance of H&N Super Nick parent stock under good management and moderate environment

Age week	Liveability	Rate of Lay	Egg Number	Hatching Eggs		Hatch %		No. of saleable chicks		Egg weight	Body weight	
	%	HD %	HH cum.	%	cum.	total chicks	saleable chicks	per week	cum.	g	Female g	Male g
20	100.0										1358	1721
21	99.9	30.0	2.1	0	0.0	0.0	0.0	0.0	0.0	45.0	1400	1787
22	99.8	57.0	6.1	30	1.2	65.6	32.0	0.4	0.4	47.5	1438	1850
23	99.7	75.0	11.3	60	4.3	74.1	36.2	1.1	1.5	49.6	1472	1908
24	99.7	84.9	17.2	70	8.4	78.1	38.1	1.6	3.1	51.6	1502	1963
25	99.6	90.5	23.5	80	13.4	80.9	39.5	2.0	5.1	53.4	1529	2012
26	99.5	93.1	30.0	85	18.9	83.0	40.5	2.2	7.3	54.9	1553	2055
27	99.4	94.2	36.6	90	24.8	84.8	41.4	2.4	9.7	56.1	1574	2094
28	99.3	94.7	43.2	93	30.9	86.2	42.1	2.6	12.3	56.9	1592	2127
29	99.2	94.9	49.8	94	37.1	87.3	42.6	2.6	14.9	57.7	1607	2156
30	99.1	95.1	56.4	95	43.4	88.3	43.1	2.7	17.6	58.3	1619	2179
31	99.0	95.1	63.0	96	49.7	89.0	43.4	2.7	20.3	58.7	1628	2198
32	98.9	95.1	69.6	96	56.0	89.4	43.6	2.7	23.0	59.1	1633	2211
33	98.8	95.1	76.2	96	62.3	89.7	43.8	2.8	25.8	59.3	1636	2219
34	98.7	95.1	82.8	96	68.6	89.9	43.9	2.8	28.6	59.5	1638	2224
35	98.6	95.1	89.4	96	74.9	90.0	43.9	2.8	31.4	59.7	1640	2227
36	98.5	95.0	96.0	96	81.2	90.0	43.9	2.8	34.2	59.9	1642	2230
37	98.4	94.9	102.5	96	87.4	89.9	43.9	2.7	36.9	60.0	1644	2233
38	98.3	94.9	109.0	96	93.6	89.7	43.8	2.7	39.6	60.1	1646	2236
39	98.2	94.7	115.5	96	99.8	89.5	43.7	2.7	42.3	60.2	1648	2238
40	98.0	94.6	122.0	96	106.0	89.2	43.5	2.7	45.0	60.3	1650	2241
41	97.9	94.4	128.5	96	112.2	88.9	43.4	2.7	47.7	60.4	1652	2244
42	97.7	94.3	134.9	96	118.3	88.6	43.2	2.6	50.3	60.5	1654	2247
43	97.5	94.1	141.3	96	124.4	88.3	43.1	2.6	52.9	60.5	1656	2250
44	97.4	93.9	147.7	95	130.5	88.0	42.9	2.6	55.5	60.6	1658	2253
45	97.2	93.7	154.1	95	136.6	87.7	42.8	2.6	58.1	60.7	1660	2256
46	97.0	93.4	160.4	95	142.6	87.4	42.7	2.6	60.7	60.7	1662	2259
47	96.8	93.2	166.7	95	148.6	87.0	42.5	2.6	63.3	60.8	1664	2262
48	96.6	92.9	173.0	95	154.6	86.6	42.3	2.5	65.8	60.8	1666	2265
49	96.5	92.6	179.3	95	160.6	86.2	42.1	2.5	68.3	60.9	1668	2268
50	96.3	92.4	185.5	95	166.5	85.8	41.9	2.5	70.8	60.9	1670	2270

PERFORMANCE GOALS

Table 27: Production performance of H&N Super Nick parent stock under good management and moderate environment

Age week	Liveability %	Rate of Lay HD %	Egg Number HH cum.	Hatching Eggs		Hatch %		No. of saleable chicks		Egg weight g	Body weight	
				%	cum.	total chicks	saleable chicks	per week	cum.		Female g	Male g
51	96.1	92.1	191.7	95	172.4	85.4	41.7	2.5	73.3	61.0	1672	2272
52	95.9	91.8	197.9	94	178.2	85.0	41.5	2.4	75.7	61.0	1674	2274
53	95.7	91.4	204.0	94	183.9	84.6	41.3	2.4	78.1	61.1	1676	2276
54	95.5	91.1	210.1	94	189.6	84.2	41.1	2.3	80.4	61.1	1678	2278
55	95.3	90.7	216.2	94	195.3	83.8	40.9	2.3	82.7	61.2	1680	2280
56	95.1	90.4	222.2	94	200.9	83.3	40.7	2.3	85.0	61.2	1682	2282
57	94.9	90.0	228.2	94	206.5	82.8	40.4	2.3	87.3	61.2	1683	2284
58	94.6	89.5	234.1	94	212.0	82.3	40.2	2.2	89.5	61.3	1684	2286
59	94.4	89.1	240.0	93	217.5	81.8	39.9	2.2	91.7	61.3	1685	2288
60	94.2	88.7	245.8	93	222.9	81.3	39.7	2.1	93.8	61.3	1686	2290
61	94.0	88.2	251.6	93	228.3	80.8	39.4	2.1	95.9	61.4	1687	2292
62	93.8	87.7	257.4	93	233.7	80.3	39.2	2.1	98.0	61.4	1688	2294
63	93.5	87.2	263.1	93	239.0	79.7	38.9	2.1	100.1	61.4	1689	2296
64	93.3	86.7	268.8	92	244.2	79.1	38.6	2.0	102.1	61.5	1690	2298
65	93.0	86.1	274.4	92	249.4	78.5	38.3	2.0	104.1	61.5	1691	2300
66	92.8	85.6	280.0	92	254.6	77.9	38.0	2.0	106.1	61.5	1692	2302
67	92.5	85.0	285.5	92	259.7	77.3	37.7	1.9	108.0	61.5	1693	2304
68	92.3	84.4	291.0	91	264.7	76.7	37.4	1.9	109.9	61.5	1694	2306
69	92.0	83.8	296.4	91	269.6	76.1	37.1	1.8	111.7	61.6	1695	2308
70	91.7	83.1	301.7	91	274.4	75.4	36.8	1.8	113.5	61.6	1696	2309
71	91.4	82.5	307.0	90	279.2	74.7	36.5	1.8	115.3	61.6	1697	2310
72	91.2	81.8	312.2	90	283.9	74.0	36.1	1.7	117.0	61.6	1698	2311
73	90.9	81.1	317.4	90	288.6	73.3	35.8	1.7	118.7	61.6	1699	2312
74	90.6	80.4	322.5	90	293.2	72.6	35.4	1.6	120.3	61.6	1700	2313
75	90.3	79.6	327.5	90	297.7	71.9	35.1	1.6	121.9	61.6	1701	2314

ACKNOWLEDGEMENT

We would like to thank following companies for sharing the pictures:

Mike Czarick – University of Georgia

Silvina Emacora – Cabaña Barhy

Carlos Gonzalez – Industria Genética Guatemala

Juan Pablo Villalda – Pronavicola

Luke Stalter – H&N North America

Nicole Paradis – Maritime Hatchery

Cory Cox – Maritime Hatchery

Pierre-David Cyr – Westco

Nova-Tech Engineering LLC

DISCLAIMER

The information, advices and suggestions given in this management guide should be used for guidance and educational purposes only, recognizing that local environmental and disease conditions may vary and a guide cannot cover all possible circumstances. While every attempt has been made to ensure that the information presented is accurate and reliable at

the time of publication, H&N International cannot accept responsibility for any errors, omissions or inaccuracies in such information or management suggestions.

Further, H&N International does not warrant or make any representations or guarantees regarding the use, validity, accuracy, or reliability of, or flock performance

or productivity resulting from the use of, or otherwise respecting, such information or management suggestions. In no event H&N International be liable for any special, indirect or consequential damages or special damages whatsoever arising out of or in connection with the use of the information or management suggestions containing in this management guide.



IMPRINT

Editor
H&N International GmbH
Am Seedeich 9 | 27472 Cuxhaven | Germany
Phone +49 (0)4721 564-0
E-mail: info@hn-int.com | Internet: www.hn-int.com
Photo credits
H&N International GmbH

© H&N International
All rights reserved. Reproduction in whole or in part is
only permitted with referencing the source.