

# PARENTS STOCK

**Management  
Handbook**

2018



## **This Handbook**

The purpose of this Handbook is to help Aviagen® customers to optimize the performance from their parent stock. It is not intended to provide definitive information on every aspect of parent stock management, but to draw attention to important issues, which if overlooked or inadequately addressed, may depress flock performance. The management techniques contained within this Handbook have the objectives of maintaining flock health and welfare, and achieving good flock performance.

## **Introduction**

Aviagen produces a range of genotypes suitable for different sectors of the broiler market. All Aviagen products are selected for a balanced range of parent stock and broiler characteristics. This variety allows our customers to choose the product that best meets the needs of their particular operation.

As parent stock, all Ross® genotypes are selected to produce the maximum number of vigorous day-old chicks by combining high egg numbers with good hatchability, fertility and welfare. This combination is achieved by mating together male lines that are bred in a balanced way with emphasis on fast growth, feed efficiency, and high meat yield, with females that are selected for the same health, welfare and broiler characteristics, and to lay high numbers of eggs.

This Handbook summarizes best practice parent stock management for all Ross parent stock, taking into account the ongoing selection for improved broiler traits. Additional management advice for specific Ross products can be found on the Aviagen website.

## **Performance**

The most common management strategy worldwide is for birds to receive first light stimulation after 21 weeks (147 days) of age and achieve 5% production at 25 weeks of age, as this gives distinct advantages in early egg size, chick numbers and broiler chick quality. However, poultry production is a global activity and across the world, differing management strategies may need to be adapted for local conditions.

The information presented is a combination of data derived from internal research trials, published scientific knowledge, and the expertise, practical skills and experience of the Aviagen Technical Transfer and Technical Service teams. However, the guidance within this Handbook cannot wholly protect against performance variations that may occur for a wide variety of reasons. Aviagen therefore accepts no ultimate liability for the consequences of using this information to manage parent stock.

## **Customer Services**

For further information, please contact your local Ross representative or visit the website at [www.aviagen.com](http://www.aviagen.com).

## Using this Handbook

### Finding a Topic

Blue tabs appear on the right-hand side of the Handbook. These tabs allow readers immediate access to those sections and topics in which they are particularly interested.

The Table of Contents gives the title and page number of each section and subsection.

An alphabetical Keyword Index is given at the end of the Handbook.

### Key Points and Useful Information



Look for this symbol to find **Key Points** that emphasize important aspects of husbandry and critical procedures.



Look for this symbol to find suggestions for further **Useful Information** on specific topics in this Handbook. These documents can be found in the Resource Center of the Aviagen website unless otherwise stated.

### Supplements to this Handbook

Supplements to this handbook contain performance objectives that can be achieved with good management, as well as nutritional, environmental and health control. Nutrition specifications are also available. All management information can be found online at [www.aviagen.com](http://www.aviagen.com), by contacting your local Ross representative, or by emailing [info@aviagen.com](mailto:info@aviagen.com).

**Table of Contents**

7	<b>Key Management Timetable</b>
10	<b>Stockmanship</b>
	<b>Section 1 - Rearing (0-105 days/0-15 weeks)</b>
15	<b>Management Requirements for Males and Females During Rear</b>
17	Chick Management
30	Equipment and Facilities
37	Best Practice in the Absence of Beak Treatment
38	<b>Grading to Manage Uniformity</b>
39	General Procedures for Grading
42	Flock Management After Grading (Post 28 Days)
	<b>Section 2 - Management into Lay (15 Weeks to Peak Production)</b>
49	<b>From 105 Days (15 Weeks) to Light Stimulation</b>
49	Management Considerations
60	<b>Management of Females Post Light Stimulation Until 5% Production</b>
60	Management Considerations
61	Floor Eggs
62	Nest Box Set-up
63	<b>Management of Females from 5% Hen-day Production Until Peak Egg Production</b>
63	Management Considerations
64	Feed Clean-up Trends
65	Egg Weight and Feed Control
67	<b>Management of Males Post Light Stimulation Until Peak Egg Production</b>
67	Feeding Considerations
68	Mating Ratio
69	Over-mating
	<b>Section 3 - Management in Lay (Peak to Depletion)</b>
71	<b>Management of Females After Peak Production Through to Depletion</b>
71	Factors for Post-peak Management
72	Procedures
72	General Guidelines for Post-peak Feed Reductions Based on Target Performance Characteristics
76	Monitoring Post-peak Feed Reduction
78	Post-peak Feed Reductions and Environmental Temperature
79	<b>Management of Males After Peak Production Through to Depletion</b>
79	Procedures

	<b>Section 4 - Monitoring Broiler Breeder Growth</b>
<b>81</b>	<b>Monitoring Broiler Breeder Growth</b>
81	Body-weight Weighing Methods
83	Methodology for Sample Weighing
	<b>Section 5 - Assessment of Bird Physical Condition</b>
<b>89</b>	<b>Assessment of Bird Physical Condition</b>
89	Assessing Bird Condition
90	Assessment of Male Condition
97	Assessment of Female Condition
	<b>Section 6 - Care of Hatching Eggs on Farm</b>
<b>101</b>	<b>Care of Hatching Eggs</b>
101	Why Do Hatching Eggs Need Care?
102	The Egg's Protection System
104	Best Practice for Care of Hatching Eggs
	<b>Section 7 - Environmental Requirements</b>
<b>109</b>	<b>Housing</b>
109	Farm Location and Design
111	House Design
<b>113</b>	<b>Ventilation</b>
113	Air
114	Housing and Ventilation Systems
117	Minimum Ventilation
124	Transitional Ventilation
126	Tunnel Ventilation
128	Evaporative Cooling Systems
132	Light Baffles
<b>133</b>	<b>Lighting</b>
133	Lighting During Brooding
133	Lighting Programs and Housing Type
142	Wavelength (Light Color) and Lamp Type
	<b>Section 8 - Nutrition</b>
<b>143</b>	<b>Nutrition</b>
143	Broiler Breeder Nutrition
143	Supply of Nutrients
147	Feeding Programs and Diet Specifications
149	Feed Manufacturing
151	Water

**Section 9 - Health and Biosecurity**

**153 Health and Biosecurity**

153 The Relationship Between Management, Disease Expression and Bird Welfare

154 Hygiene Management

159 Water Quality

161 Dead Bird Disposal

162 Health Management

165 Health Monitoring Programs

**Appendices**

167 Appendix 1 - Records

169 Appendix 2 - Useful Management Information

171 Appendix 3 - Conversion Tables

174 Appendix 4 - Grading Calculations

178 Appendix 5 - Dew Point or Condensation Table

181 Appendix 6 - Calculations for Ventilation Rates

182 Appendix 7 - Troubleshooting - Vitamin Deficiency

183 Appendix 8 - Nutrient Composition of Some Commonly Used Feed Ingredients

**Keyword Index**

184 Keyword Index

### Key Management Timetable

The critical age objectives for parent stock are summarized in the table below.

Age (days)	Action
Before chick delivery	<p>All housing and equipment should be cleaned and disinfected and effectiveness of biosecurity operations verified prior to chick placement.</p> <p>Preheat the house. Temperature and relative humidity (RH) should be stabilized for at least 24 hours, prior to the chicks being delivered.</p> <p>House set-up should be completed prior to chick arrival. Litter should be evenly spread on the floor, that has been preheated to a temperature of 28-30°C (82-86°F). Litter temperature should also be 28-30°C (82-86°F). Drinkers and feeders must be in place and should be filled immediately prior to placement so chicks have immediate access to feed and water.</p> <p>Ensure good biosecurity. Pathogens can survive in the surrounding environment even before the chicks have been placed. Biosecurity before chick delivery is equally, if not more, important than biosecurity after chick arrival.</p>
On chick arrival	<p>Achieve optimum environmental temperature, which is critical for stimulating both appetite and activity.</p> <p>Establish a minimum ventilation rate, which will ensure that fresh air is supplied to the chicks, help to maintain temperature and relative humidity (RH), and allow sufficient air exchange to prevent the accumulation of harmful gases.</p> <p>Monitor chick behavior to ensure that temperature is satisfactory.</p> <p>Bulk weigh a sample of chicks.</p>
0-7	<p>Develop appetite from good brooding practice.</p> <p>Ensure adequate drinker and feeder space, provide good quality feed and maintain optimum temperatures.</p> <p>Provide 23 hours of light and 1 hour of dark for the first 2 days after placement.</p> <p>Light intensity must be uniformly distributed throughout the brooding area. A light intensity of 80-100 lux (7-9 fc) must be provided in the brooding area to promote feed and water intake.</p> <p>Use crop fill assessment as an indication of appetite development.</p> <p>Monitor bird behavior and adjust house environment as necessary.</p>
7-14	<p>Achieve target body weights.</p> <p>Obtain body-weight sample. A bulk weighing of birds is required at 7 and 14 days of age. A minimum of 2% or 50 birds (whichever is larger) should be weighed from each population.</p> <p>Where possible, provide a constant (8 hour) daylength by 10 days of age. In open-sided houses, daylength will depend on the placement date and the natural daylength patterns.</p> <p>Increasing the number of birds weighed or the frequency of weighing (to 2-3 times a week) during the first 2-3 weeks after placement will be beneficial.</p> <p>If 14-day (2-week) body weights for previous flocks have regularly been below target, a longer daylength can be provided until 21 days (3 weeks) of age to help stimulate feed intake and improve body-weight gain.</p>

Age (days)	Action
14-21	Start recording individual body weights between 14 and 21 days (2 and 3 weeks) of age. This information is required to calculate body-weight uniformity (CV%).
28	Grade males and females at 28 days (4 weeks).  After grading, revise body-weight profiles to ensure that birds achieve target body weights by 63 days (9 weeks).
28-63	Ensure adequate feeder space and feed distribution is achieved.  Monitor and record body weight weekly.  If necessary, adjust daily feed allocation for the male and female populations to achieve any revised body-weight targets and maintain uniformity.  The main focus during this period is to achieve good skeletal uniformity and correctly control the growth within each graded population.
63	Re-examine graded population weights in relation to the body-weight target. Combine populations that are of similar weight and feed intake.  If populations are not following the target profile, a new target body-weight line should be drawn.  For populations that are over the target weight a new target line should be drawn so that the birds are brought back to target at 105 days (15 weeks).  Populations that are under the target should gradually be brought back to target by 105 days (15 weeks).
63-105	Ensure correct feeding space and feed distribution is achieved.  Monitor and record body weight weekly.  If necessary, adjust daily feed amounts for the male and female populations to achieve the target or any revised body-weight targets, and maintain uniformity.  The main focus during this period is to correctly control the growth within each graded population.
105	Re-examine body weights in relation to target.  Underweight birds need to be brought back to target by 147 days (21 weeks).  For populations that are over the target weight, a new target line should be drawn parallel to the target.  Remove any sexing errors as they are identified.  Movement of birds between populations should stop.
105-161	Ensure correct feeding space and feed distribution is achieved.  Achieve correct weekly body-weight gains by ensuring the appropriate feed amounts are given, particularly from 105 days (15 weeks) onwards.  All populations should achieve similar body weight by light stimulation. Significant variation in body weight between populations at this age will lead to production problems in lay.  Monitor and record body weight weekly.



Age (days)	Action
126-147	Remove remaining sexing errors. Begin assessment of pin bone spacing.
140	Calculate and record the uniformity (CV%) and evaluate the sexual maturity of the flock to determine the lighting program.  If the flock is even (CV less than or equal to 10%), follow the normal recommended lighting program.  If the flock is uneven (CV greater than 10%), light stimulation should be delayed by 7-14 days (1-2 weeks).
147-161	First light increase given (not before 147 days/21 weeks of age).  Monitor and record body weight weekly.
147-168	Mating-up: the exact time will depend on the relative maturity of both males and females.  Immature males should never be mated with mature females.  If males are more mature than females, they should be introduced gradually.  Monitor and record body weight weekly.
168-175	Introduce the breeder feed from 5% hen-day production at the latest.
161-196	From first egg, increase feed amounts according to the rate of daily egg production, daily egg weight and body weight.  Monitor and record body weight weekly.
210-depletion	Manage males by observing bird condition.  Remove non-working males to maintain appropriate mating ratios.  Monitor and record body weight.
245-depletion	Female post-peak feed reduction should be started approximately 35 days (5 weeks) after peak production is achieved, which is generally at 252 days (36 weeks) of age.  Feed intake should be reviewed weekly and any reductions in feed should be based on feed clean-up time, egg production, daily egg weight, egg mass and body weight.

**BIRD HANDLING**

It is important that all birds are handled in a calm and correct way at all times. All people handling birds should be experienced and appropriately trained so that they can handle the birds with the care that is appropriate for the purpose, age and sex of the bird.

## Stockmanship

The importance of stockmanship for parent stock welfare, performance and profitability must not be underestimated. A good stockman will be able to identify and respond to problems quickly.

The stockman must apply and interpret the best practice recommendations given in this Handbook and use them in combination with their own professional competence, practical knowledge, skills and ability to meet the birds' needs.

The stockman must be constantly in tune with and aware of all the birds in the flock and their environment. To do this, the birds' behavioral characteristics and the conditions within the poultry house must be closely observed. This monitoring is commonly referred to as "stock sense" and is a continuous process that uses all the stockman's senses (**Figure 1**).

**Figure 1:** Stockmanship - using all the senses to monitor the flock.

### Hearing

Listen to the birds' vocalization, breathing and respiratory sounds. Listen to the mechanical sounds of fan bearings and feed augers.

### Sight

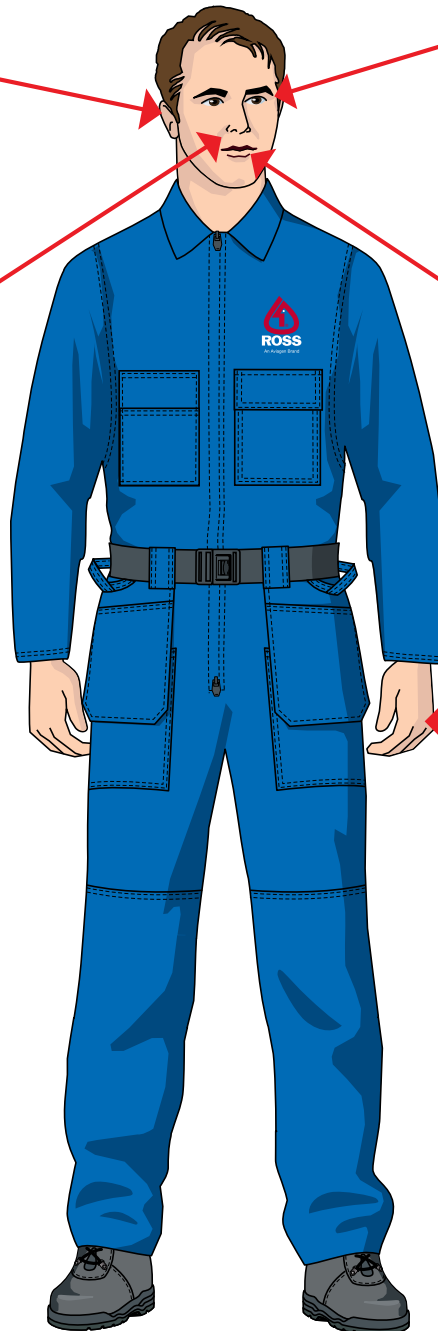
Observe behaviors such as bird distribution in the house and number of birds feeding, drinking, preening, mating and using nest boxes. Observe the environment such as dust in the air and litter quality. Observe bird health and demeanor such as posture, alertness, eyes and gait.

### Smell

Keep notice of smells in the environment such as ammonia levels. Is the air stale or stuffy?

### Taste

Water and feed quality.



### Feel

Handle the birds to assess crop fill and check the birds' general condition (breast conformation, vent and feather condition). Take notice of air movement across your skin. Is there a draft? What does the temperature of the house feel like?

## Practical Stockmanship

The body-weight and egg production targets at a given age are usually the same across flocks, but each individual flock will have slightly differing management requirements to achieve those targets. To understand the individual management requirements of a flock and to be able to respond to each flock appropriately, the stockman must know and also sense what is normal for the flock.

The stockman has an important role to play in maintaining the welfare, health and performance of a flock. If only farm records (growth, feed consumption, etc) are monitored, important signals from the birds and their environment will be missed. Often the first signs that there is a problem or inadequacy in the environment are subtle changes in bird behavior. By understanding what is normal for a flock, any changes in behavior or development of abnormal behavior for that flock can be quickly identified. Using all the senses, the stockman must build up an awareness of the environment, the birds' experience and an understanding of what the normal behavioral characteristics of the flock are. This information should be continuously analyzed (in conjunction with the farm records, the stockman's previous experience and knowledge and consideration of the environment the flock is experiencing) to allow any shortfalls in the birds' condition and/or environment to be rapidly identified and corrected.

The flock environment and behavior should be observed at various times of the day by the same person. This observation should be done at any time day-to-day management activities are completed in the house, but importantly, some specific inspections just to monitor flock behavior should be also made.

Before entering the house, the time and ambient climatic conditions should be noted. This will help determine how the fans, heaters, cool cells and inlets should be operating when compared to the system's set points.

Upon entry to the house, gently knock on and gradually open the door and ask yourself the following question:

### **Does the door into the house open with a slight resistance, no resistance or high resistance?**

The answer to this question will indicate the air pressure within the house and reflect the ventilation settings, i.e. inlet openings, fan operation.

Slowly enter the house and stop until the birds become accustomed to your presence. During this time, continuously use all your senses to assess the flock condition. **LOOK, LISTEN, SMELL AND FEEL.**

#### **LOOK AT:**

- **Bird distribution.** Are specific areas of the house being avoided, suggesting an environmental issue (draft, cold, light), or are females avoiding males (incorrect mating ratio)?
- **Bird respiration.** Are the birds panting? Is the panting specific to one area of the house, suggesting an air flow or temperature issue?
- **Bird behavior - feeding, drinking, mating and resting.** Ensure behaviors are appropriate for the time of day.
- **Number of fans running, inlet position, are the heaters running?** Are the heaters coming on as soon as the fans go off or are the fans and heaters running at the same time, i.e. do the set points need adjustment?
- **Cool cell.** Depending on the set points, is pad area wet, dry or a combination? Is the water pump functioning and the water being distributed evenly on the pads?
- **Litter condition.** Are areas capping due to leaking drinkers or excess water from cool cells? Is cold air entering the house and falling to the floor?
- **Feeders and drinkers.** Are they the right height? Is there feed in the feeders? Are the drinkers leaking? What is feed quality like?

#### **LISTEN TO:**

- **The birds.** Are the birds snicking/sneezing? What are their vocalizations like? How do the birds sound compared to previous visits? Is it a vaccination response or is it related to a dusty, poor environment? Often, listening to the birds is best done in the evening when ventilation noise, etc., is reduced.
- **The feeders.** Are the mechanical augers or chains constantly running? Has the daily feed amount been completely distributed?
- **The fans.** Are the fan bearings noisy? Do fan belts sound loose? Routine maintenance can prevent environmental issues related to suboptimal air quality.

**FEEL:**

- **The air.** How does the air feel on your face? Is it stuffy (humid), cold, hot? Is there fast air speed or no air speed? These, either in combination or solely, can indicate specific environmental issues such as not enough minimum ventilation.
- **The feed physical quality.** Is the crumb very dusty? Do the pellets break down very easily in the hand and in the feeder?
- **The litter condition.** Pick up and feel the condition of the litter. If the litter stays together after compressing (does not spring apart), it indicates excessive moisture, which may suggest ventilation inadequacies. If litter is dry, it will remain friable and fall apart after compressing.

**SMELL:**

- **The feed.** What does the feed smell like? Does it smell fresh or musty?
- **The environment.** What does the environment smell like? Can you smell ammonia?

After the initial entry into the house and observation of the flock and the environment, slowly walk the entire house, assessing the points above. Walking the entire house is important to ensure that there is minimal variation in the environment and bird behavior throughout the house, and not just in the area you are standing. When walking through the house, get down to bird level. Pick up any birds that do not move away. Are they sick? How many birds are affected? Assess the way the flock moves in front of and behind you. Do the birds move back to fill the space created by walking through the flock?

Periodically stop to handle and assess individual birds for the following:

- **Eyes.** Should be clear, no signs of irritation.
- **Skin.** Should be unblemished with no scratches.
- **Breast.** Monitor fleshing confirmation scores.
- **Body condition.** Check sexual maturity.
- **Feathering.** Evaluate feathering score.
- **Leg health.** What is the gait of the birds?
- **Feet.** Should be clean with no irritation markings.
- **Vent.** Should be clean with no signs of loose droppings. In mating birds, check vent color of males.
- **Beak and tongue.** Should have no nasal discharge (or feed sticking to beak), and no signs of tongue discoloration or mouth lesions.
- **Crop.** Are they feeding? Does the crop contain litter? Is the crop very hard or soft? This will indicate the water availability.
- **General demeanor and alertness.**

These observations will help build a picture for each individual flock/house. **Remember, no two flocks or houses are the same!**

Compare this stock sense information with actual farm records. Are the birds on target? If there are any irregularities, they must be investigated and an action plan should be developed to address any issues that occur.

**The Relationship Between Stockmanship and Bird Welfare**

Stock sense, combined with the stockmans knowledge, experience and skills in husbandry will produce a rounded technician who will also have personal qualities such as patience, dedication and empathy when working with the birds. The implementation of the Three Essentials of Stockmanship will not only bring the birds as close as possible to the ideal state of "The Five Freedoms of Animal Welfare" (**Figure 2**), it will ensure efficiency and profitability.

The Three Essentials of Stockmanship include:

**Knowledge of animal husbandry.** Sound knowledge of the biology and husbandry of farm animals, including how their needs may be best provided for in all circumstances.

**Skills in animal husbandry.** Demonstratable skills in observation, handling, care and treatment of animals, and problem detection and resolution.

**Personal qualities.** Affinity and empathy with animals, dedication and patience.

*(Source: Farm Animal Welfare Committee (FAWC) defined as the 'ideal state to strive for').*

**Figure 2: The Five Freedoms of Animal Welfare.**

*(Source: Farm Animal Welfare Committee (FAWC) defined as the 'ideal state to strive for').*

**The Five Freedoms for Animal Welfare**

- Freedom from hunger and thirst.
- Freedom from discomfort.
- Freedom from pain, injury and disease.
- Freedom to express normal behavior.
- Freedom from fear and distress.



**Notes**

A series of horizontal dotted lines for taking notes.

# Section 1 - Rearing (0-105 days/0-15 weeks)

## Management Requirements for Males and Females During Rear

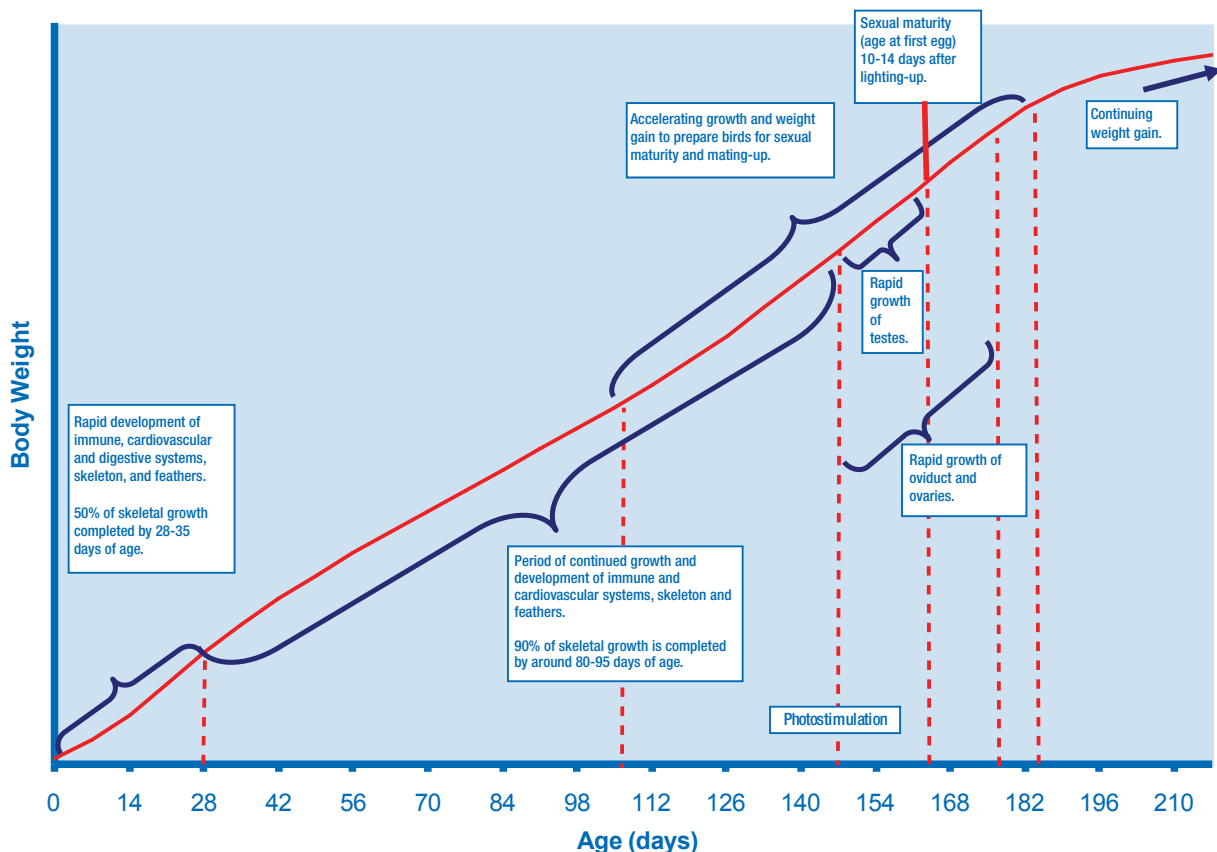
### Objective

To meet the requirements of male and female parent stock during each stage of rear, and to prepare them for sexual maturity.

### Principles

Growing the Ross parent to the target growth curve in rear allows males and females to achieve optimum lifetime reproductive performance by ensuring that the birds grow and develop correctly. **Figure 3** shows the progression of bird growth and development over time. At different points in time, different organs and tissues will develop. Within each phase of growth, the flock manager should consider, and be aware of, the birds' priorities for growth at that time. Management and feed amounts must be adjusted in response to the birds' needs.

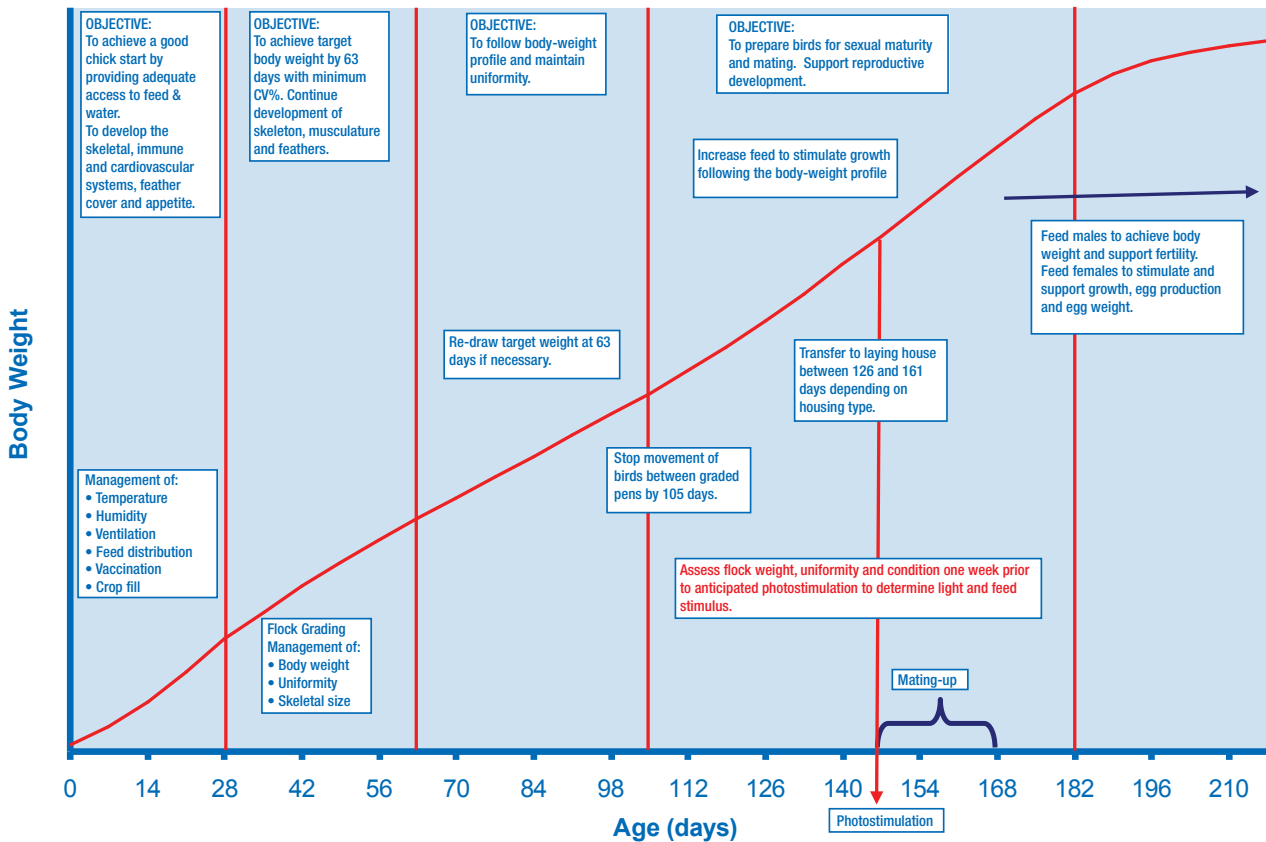
**Figure 3:** Bird growth and development.\*



\*The principles of growth and development will be the same for both males and females but absolute growth rates will be different.

Figure 4 details the important management considerations for each phase of bird growth illustrated in Figure 3.

Figure 4: Management progression.



Males and females are reared separately from day-old to mating-up at 147-168 days (21-24 weeks of age), but the principles for managing males and females in the rearing period are the same (apart from differences in body weight and feeding programs). The males form 50% of the breeding value of the flock and are therefore, just as important as females. So the management of the males requires the same attention to detail as that of the females. Growing the two sexes separately using separate feeding and drinking systems ensures that growth and uniformity can be controlled properly, thus providing more control over body weight and fleshing.



**Other Useful Information Available**

*Aviagen Poster: Broiler Breeder Growth Profile*

*Aviagen Poster: Uniformity of Female Broiler Breeders*



## Chick Management

Providing chicks with a good start is essential for the subsequent health, welfare, uniformity and performance of the flock. Chick management should successfully establish the flock from day-old by developing feeding and drinking behavior, and providing the correct environmental and management conditions to adequately meet the requirements of the chick.

### Chick Preparations at the Hatchery

Only in circumstances where it is anticipated that the welfare of the birds will be challenged should any preventative procedures be undertaken during chick processing in the hatchery.

In situations where bird health is likely to be compromised or where there is a local disease challenge or local legislation dictates, procedures such as vaccination may be required. Where this is found to be necessary, it is essential that consultation with a veterinarian takes place and that vaccination is only completed by properly trained staff using the correct equipment.

The necessity for any other processing procedures must be regularly reviewed. Processing procedures should only be undertaken after investigations into the birds' environment and management conditions have taken place. Procedures undertaken during chick processing at the hatchery should be completed to the highest standard; variations in the quality of chick handling can lead to welfare problems.

Animal welfare regulations and recommendations are regularly reviewed and updated with regional variations. Regional and national regulations must be followed.

### Planning Before Chick Placement

The expected delivery date, time and number of chicks should be established with the supplier well in advance of chick placement. This will ensure that the appropriate brooding set-up is in place and that chicks can be unloaded and placed as quickly as possible.

If the stock is being imported, appropriately trained personnel must be available to supervise and liaise with any customs clearance regulation formalities, especially where bird health is likely to be compromised, there is a local disease challenge, or to meet local legislation requirements. Chicks should always be held in a dry, sheltered environment at the correct temperature for their welfare.

Chick placements should be planned so that chicks from different-aged donor flocks can be brooded separately. Chicks from young donor flocks will achieve target body weights more easily if kept separate until the time of grading at 28 days (4 weeks) of age.

Chicks should be transported from the hatchery to the farm in an environmentally controlled vehicle (**Figure 5**). During transportation:

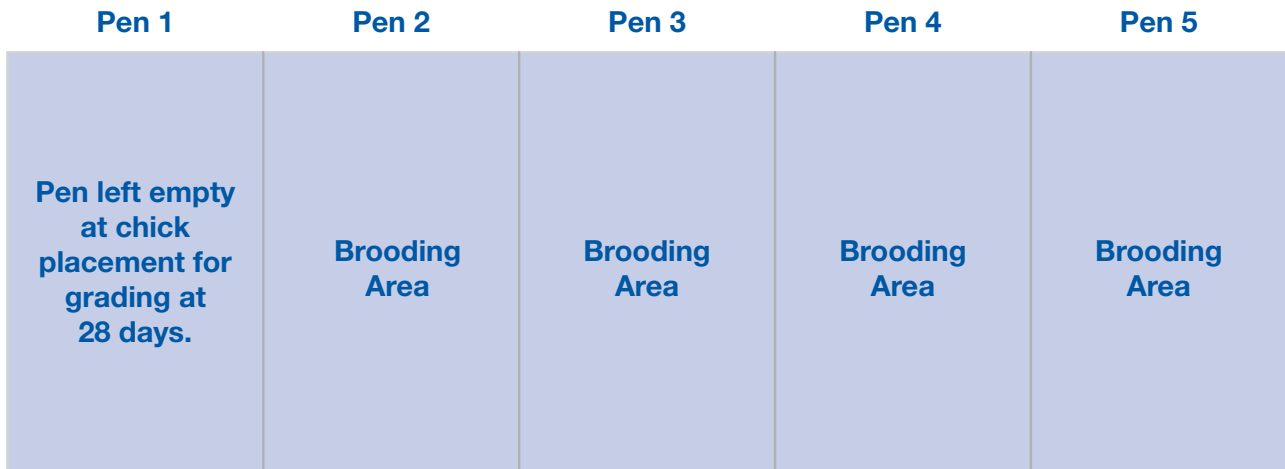
- Temperature should be adjusted so that the chick vent temperature is held between 39.4-40.5°C (103-105°F). Note that the required temperature control settings can vary between different vehicle designs.
- Relative humidity (RH) should be between 50-65%.
- A minimum of 0.71 cubic meters per minute (25 cubic feet per minute) of fresh air per 1,000 chicks should be supplied. Greater ventilation rates may be required if the truck is not air-conditioned and ventilation is the only method available to cool the chicks.

**Figure 5:** Typical controlled environment chick delivery vehicles.



At placement, plan the house set-up for future grading procedures by leaving at least 1 pen empty (**Figure 6**) so that at grading, populations can be grown separately according to their requirements.

**Figure 6:** Example of a typical house set-up pre-placement for 8,000 chicks, leaving 1 pen empty for grading at 28 days.



- Be prepared - know what is coming and when.
- Plan placements so that chicks from different-aged donor flocks can be brooded separately.
- Closely monitor the chick holding and transport environments to prevent the chicks from becoming chilled or overheated.
- Plan areas for grading.

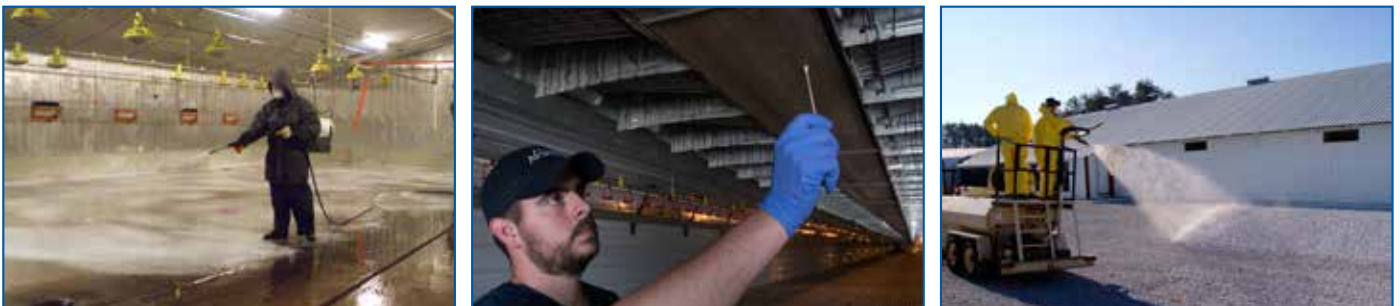
**Farm Preparations for Chick Arrival**

**Biosecurity**

Individual sites should hold birds of a single age and be managed on the principles of "all-in, all-out." Vaccination and cleaning programs are easier and more effective on single-age sites, with consequent benefits in bird health and performance.

Houses, the areas surrounding the houses, and all equipment (including the water and feed systems) must be thoroughly cleaned and disinfected before the arrival of the litter material and chicks (**Figure 7**). A recommended hygiene program and efficacy testing procedure should be in place to ensure that the correct biosecurity is achieved at least 24 hours before the chicks arrive (see section on *Health and Biosecurity* for further information).

**Figure 7:** Good house cleaning practices. Power washing the house (left), testing the house for bacterial contamination (center), and disinfecting the exterior with lime (right).



The area surrounding the house should be free from vegetation and be able to be easily cleaned (**Figure 8**).

**Figure 8:** Houses with a low biosecurity risk showing concrete areas and no vegetation around the immediate perimeter of the house.



Within the house itself, concrete floors are necessary to allow effective washing, disinfection and litter management.

Vehicles (**Figure 9**), equipment and people must be disinfected prior to entering the farm.

**Figure 9:** Methods of disinfecting vehicles before entering a farm.



- Provide chicks with biosecure, clean housing.
- Control spread of disease by using single-age (all-in, all-out) housing.
- Follow a recommended hygiene program and have a procedure in place to test its effectiveness.

**House preparation and layout**

For chicks at placement, achieving both correct air temperature and correct floor temperature is necessary for a good chick start. Preheating the house before placement is therefore essential. Temperature (air and floor) and relative humidity (RH) should be stabilized for at least 24 hours prior to the chicks being placed. A longer pre-warm (up to 48 hours) may be required if external environmental conditions are cold or if it is the first flock in a newly built house. At placement, the environmental conditions required are:

- An air temperature of 30°C/86°F (measured at chick height in the area where feed and water are positioned).
- A floor temperature of 28-30°C (82-86°F).
- A relative humidity of 60-70%.

Prior to the chicks arriving, litter material should be spread evenly to a depth of 2-5 cm (0.8-2 in). Where floor feeding is to be practiced after brooding, litter depth should not exceed 4 cm (1.6 in). Litter depth can also be reduced where litter disposal is an issue. Where a thinner layer of litter is used, it is essential that the correct floor temperature (28-30°C/82-86°F) is achieved prior to chick arrival. Providing more than 5 cm (2 in) of litter can create a problem of litter movement leading to chicks becoming buried, especially if the litter is spread unevenly.

The choice of litter material is influenced by cost and availability, but a good litter material should have the following properties:

- Good moisture absorption.
- Biodegradability.
- Good bird comfort.
- Low dust level.
- Freedom from contaminants.
- Consistent availability from a biosecure source.

At placement, and for the first 24 hours after placement, chicks should not have to travel more than 1 m (3.3 ft) for access to water. Provide nipple lines with an allowance of 12 birds per nipple, or bell drinkers at a minimum of 8 drinkers per 1000 chicks. Twelve mini-drinkers or trays per 1000 chicks should also be available. Water lines should be flushed prior to chick arrival. Flushing thereafter may be required if there is a risk of biofilm build-up (for example, if water soluble additives are added to the water). However, take care to ensure that chicks are never given cold water. The water supplied to the chicks should be approximately 18 to 21°C/64 to 70°F (Table 1).

**Table 1:** Effect of water temperature on water intake.

Water Temperature	Water Intake
Less than 5°C (41°F)	Too cold, reduced water consumption
18-21°C (64-70°F)	Ideal
Greater than 30°C (86°F)	Too warm, reduced water consumption
Above 44°C (111°F)	Birds refuse to drink

After house cleaning and prior to chick delivery, the drinking water should be sampled at the source, at the storage tanks and at the drinker points, for bacterial contamination (see section on *Health and Biosecurity* for more information).

Any treatment of water with products (such as water soluble additives) that could encourage the growth of bacteria in the pipes should be followed by an effective water sanitation program. This program should not affect the birds' performance, even subsequently, when they are in lay (refer to the section on *Health and Biosecurity* for further details).


Ensure that all chicks have easy access to feed. At placement, feed should be a sieved crumb (Figure 10) or mini pellet (2 mm [0.06 in] diameter) provided on supplementary feeder trays (1 per 80 chicks) and on paper to give a feeding area occupying at least 90% of the brooding area.

**Figure 10:** Example of a crumb of good physical quality.





During brooding, the light intensity should be 80-100 lux (7-9 fc) in the area where the feed and water are positioned to encourage feeding and drinking behavior. The remainder of the house should be dimly lit (10-20 lux or 1-2 fc).



**Other Useful Information Available**

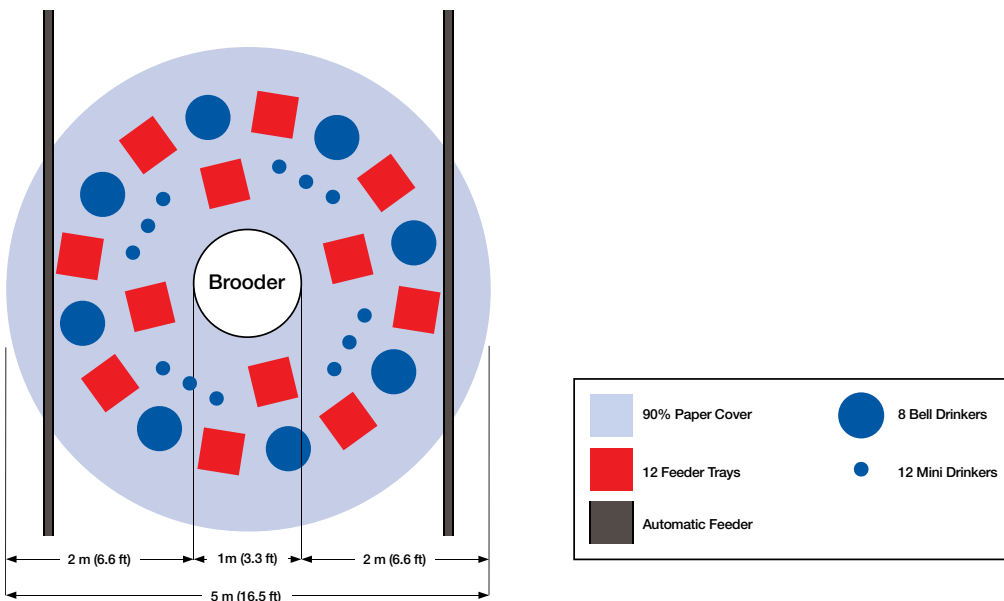
Aviagen Poster: *The First 24 Hours*

**Spot brooding**

In spot brooding, the heat source (canopy, pancake, radiant heaters and charcoal brooders) is local so chicks can move away to cooler areas and select for themselves a preferred temperature. Manufacturers' guidelines should be consulted for equipment positioning and heat output. Brooding rings are used to control early chick movement.

The layout for a spot brooding set-up, which would be typical for 1,000 chicks on day 1, is shown in **Figure 11** and **Figure 12**. The brooder surround floor should be covered with paper except directly under the brooder.

**Figure 11:** Example of a typical spot brooding layout (1,000 chicks).



Chicks should be placed in an area that gives an initial stocking density of around 40 chicks/m<sup>2</sup> (4 chicks/ft<sup>2</sup>).

**Figure 12:** Picture illustrating a good spot-brooding set-up.

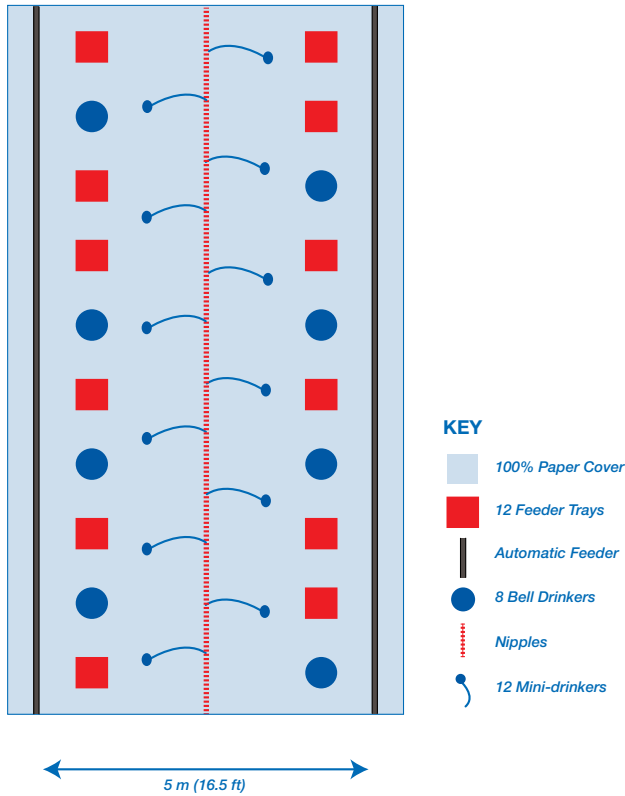


**Whole-house brooding**

In whole-house brooding (**Figure 13** and **Figure 14**), there is no temperature gradient within the house. House temperature is more constant and the ability of the chicks to move to a preferred temperature zone is limited.

The main heat source for whole-house brooding can be direct or indirect (using hot air), although supplementary brooders might also be provided.

**Figure 13:** Typical whole-house brooding layout for 1,000 chicks.



Whole-house brooding can also be done using part of the house only. In this case, the whole house must be heated before releasing the chicks. Heating the whole house will encourage chick movement into the empty area of the house when access is given at around 7 days of age.

**Figure 14:** Picture illustrating a typical whole-house brooding set-up.





- Pre-heat the house and stabilize temperature and humidity at least 24 hours prior to chick arrival.
- Ensure cleanliness of water and litter.
- Arrange equipment to enable the chicks to reach feed and water easily.
- Position supplementary feeders and drinkers near the main feeding and drinking systems.

### Chick Arrival and Placement

At placement, the chicks should be placed into the brooding area carefully and as quickly as possible (Figure 15). Chicks should not stay in the boxes longer than absolutely necessary as this increases the risk of dehydration, with resultant reduced welfare, poor chick start, uniformity and growth.

After placement, empty cardboard chick boxes should be removed and disposed of without delay. Plastic boxes should be returned for recycling after adequate disinfection protocols have been followed.

**Figure 15:** Plastic (on the left) and cardboard (on the right) chick boxes being delivered to a farm from a controlled-environment vehicle.



Chicks should be left to settle for 1 to 2 hours in their new environment after they have been placed. After this time, a check should be made that all chicks have easy access to feed and water and that environmental conditions are correct. Adjustments should be made to equipment and temperatures where necessary.



- Unload chicks carefully and place them quickly.
- Do not leave empty chick boxes lying around.
- Check feed, water, temperature and humidity after 1 to 2 hours and adjust where necessary.

### Brooding Management

Brooding is the first 7-10 days of a chick's life. Subsequent high levels of flock performance and welfare are dependent upon achieving high standards of management during this period.

It is important to replenish feed and water frequently. During the early stages of brooding (the first 3 days), the maximum daily feed allocation should be provided in small amounts given frequently (i.e. 5-6 times per day). This feeding method will avoid problems of food becoming stale and will encourage chicks to eat.

Open source drinkers (supplementary drinkers and bell drinkers) should be cleaned out and refreshed regularly as bacteria can multiply rapidly in open water at brooding temperatures. Supplementary drinkers supplied at placement should be gradually removed so that by 3-4 days of age, all chicks are drinking from the automated drinking system.

For the first 2 days, chicks should be provided with 23 hours light and 1 hour dark. After the first 2 days, daylength should be gradually reduced so that it is down to a constant 8 hours by 10 days of age (see section on *Lighting* for more details). In open-sided houses, daylength will depend on date of placement and the natural daylength patterns.

During early brooding, where chick movement is controlled by a brooding ring, the area contained by the rings should be expanded gradually from 3 days of age to increase floor space and improve feeding and drinking space. Actual increases in brooding area should be determined by chick behavior, body-weight gain and feeding and drinking equipment. Rings should be removed completely by no later than 10 days of age (see **Table 2**).

**Table 2:** Example of increase in brooding area.

Age	Birds/m <sup>2</sup> (Birds/ft <sup>2</sup> )
1-3 days	40 (4.0)
4-6 days	25 (2.5)
7-9 days	10 (1.0)
10 days	Final stocking density

Temperature and RH should be monitored and recorded daily and appropriate adjustments to the environment made in response to chick behavior to ensure that environmental conditions are optimized.

The number of feeders and drinkers and the heating capacity of the brooder must be appropriate for stocking density to prevent adverse effects on performance.

### Environmental Control

#### Humidity

Chicks kept at appropriate humidity levels are less prone to dehydration and generally make a better, more uniform start. It is important that house RH levels in the first 3 days after placement are between 60 and 70%.

RH within the house should be monitored daily using a hygrometer. If it falls below 50% in the first week, the environment will be dry and dusty. The chicks will begin to dehydrate and action should be taken to increase RH. RH can be increased by using the misters in the house (**Figure 16**) or a portable backpack sprayer to spray the walls with a fine mist. If increasing RH in this way, care must be taken to ensure that excess moisture is not added to the environment as this will result in reduced litter quality and reduced bird performance due to evaporative cooling.

**Figure 16:** Use of a mister to increase RH during brooding.



#### Temperature

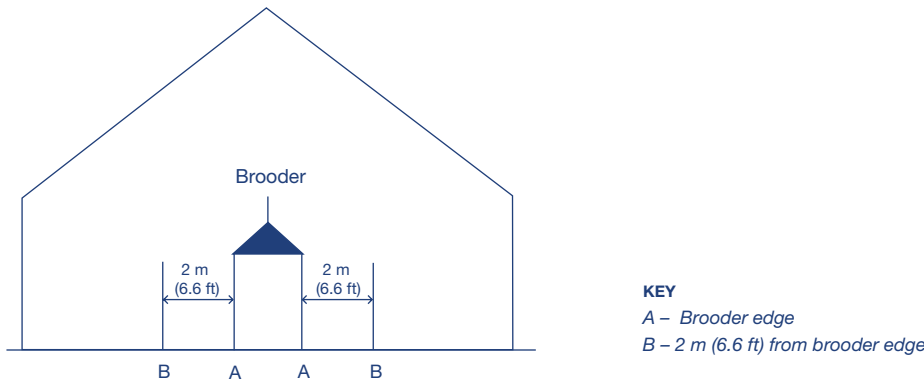
Optimal temperature (and humidity) is essential for chick health and appetite development. In both spot and whole-house brooding systems, the objective is to stimulate appetite and activity as early as possible. As chicks cannot regulate their own body temperature very well until 12-14 days of age, provision of the correct environmental temperature and adjusting environmental temperatures appropriately during brooding in response to bird behavior is critical.



A temperature guide appropriate for an RH of 60-70% is given in **Table 3**. With whole-house brooding, particular attention must be paid to monitoring and controlling house temperature and humidity, as the ability of chicks to move to a preferred temperature zone is limited.

With spot brooding, temperature gradients are created within the house. **Figure 17** shows the temperature gradients surrounding the spot brooder. These are marked **A** (brooder edge) and **B** (2 m [6.6 ft] from brooder edge). Respective optimum temperatures are shown in **Table 3**. Follow manufacturers' recommendations for equipment positioning and heat output.

**Figure 17:** Spot brooding temperature gradients.



**Table 3:** Recommended temperature guide at an RH of 60-70%.

Age (days)	Whole-House Brooding Temp °C (°F)	Spot Brooding (Refer to Figure 17)	
		Brooder Edge (A) Temp °C (°F)	2 m (6.6 ft) from Brooder Edge (B) Temp °C (°F)
Day-old	30 (86.0)	32 (89.6)	29 (84.2)
3	28 (82.4)	30 (86.0)	27 (80.6)
6	27 (80.6)	28 (82.4)	25 (77.0)
9	26 (78.8)	27 (80.6)	25 (77.0)
12	25 (77.0)	26 (76.8)	25 (77.0)
15	24 (75.2)	25 (77.0)	24 (75.2)
18	23 (73.4)	24 (75.2)	24 (75.2)
21	22 (71.6)	23 (73.4)	23 (73.4)
24	21 (69.8)	22 (71.6)	22 (71.6)
27	20 (68.0)	20 (68.0)	20 (68.0)

**Interaction between temperature and humidity (RH)**

The temperature experienced by the chick is dependent on dry bulb temperature and RH. Birds lose heat to the environment by evaporation of moisture from the respiratory tract and by heat (not evaporation) passing through the skin. At high RH, less evaporative loss occurs, increasing the animals' apparent temperature. High RH, therefore, increases apparent temperature at a particular dry bulb temperature, whereas low RH will decrease apparent temperature.

The temperature profile given in **Table 3** assumes an RH in the range of 60-70%, but if RH differs from this, optimum temperature may need to be altered accordingly. **Table 4** shows the principles of how the dry bulb temperature required to achieve the target temperature profile given above may alter in situations where RH differs from 60-70%. The figures in **Table 4** are meant as a guide only and the actual change to dry bulb temperature required at differing RH percentages may vary from those given. House temperature at chick level should be adjusted in accordance with chick behavior to ensure chick comfort is maintained.

**Table 4:** Principles of how optimum dry bulb temperatures for broilers may change at varying RH. Dry bulb temperatures, at the ideal RH at an age, are colored red.

Age (Days)	Dry Bulb Temperature °C (°F)			
	40 RH%	50 RH%	60 RH%	70 RH%
Day-old	36.0 (96.8)	33.2 (91.8)	30.8 (87.4)	29.2 (84.6)
3	33.7 (92.7)	31.2 (88.2)	28.9 (84.0)	27.3 (81.1)
6	32.5 (90.5)	29.9 (85.8)	27.7 (81.9)	26.0 (78.8)
9	31.3 (88.3)	28.6 (83.5)	26.7 (80.1)	25.0 (77.0)
12	30.2 (86.4)	27.8 (82.0)	25.7 (78.3)	24.0 (75.2)
15	29.0 (84.2)	26.8 (80.2)	24.8 (76.6)	23.0 (73.4)
18	27.7 (81.9)	25.5 (77.9)	23.6 (74.5)	21.9 (71.4)
21	26.9 (80.4)	24.7 (76.5)	22.7 (72.9)	21.3 (70.3)
24	25.7 (78.3)	23.5 (74.3)	21.7 (71.1)	20.2 (68.4)
27	24.8 (76.6)	22.7 (72.9)	20.7 (69.3)	19.3 (66.7)

\*Temperature calculations based on a formula from Dr. Malcolm Mitchell (Scottish Agricultural College).

If behavior indicates that the chicks are too cold or too hot, the house temperature should be adjusted appropriately.

**Monitoring humidity and temperature**

Temperature and humidity should be monitored at least twice a day for the first 5 days and then daily thereafter. Measurements of temperature and humidity should be taken at chick level. **Figure 18** indicates the correct positioning of automatic temperature/humidity sensors (above bird head height).

**Figure 18:** Correct location for temperature/humidity sensors.



Conventional thermometers should be used to cross-check the accuracy of electronic sensors controlling automatic systems.

**Ventilation**

Ventilation without drafts is required during the brooding period to:

- Maintain temperatures and RH at the correct level.
- Replenish oxygen.
- Remove excess moisture, carbon dioxide and noxious gases produced by the chicks and possibly the heating system.

Poor air quality due to under ventilation at brooding may cause damage to the chicks’ lung surface, making birds more susceptible to respiratory disease. Because young chicks are prone to wind-chill effects, the actual air speed at floor level should not be more than 0.15 m/sec (30 ft/min). Any ventilation applied during brooding should not impact bird temperature.



- Achieve a humidity level of 60-70% for the first 3 days.
- Maintain temperature during brooding as recommended.
- Adjust temperature according to RH to achieve recommended environmental temperatures.
- Monitor temperature and humidity regularly. Check automatic equipment with manual measurements at chick level.
- Establish a minimum ventilation rate from day 1 to provide fresh air and remove waste gases.
- Avoid drafts.
- Respond to changes in chick behavior.

**Monitoring Chick Behavior**

Temperature and humidity should be monitored daily, but by far the best indicator of correct brooding temperatures is frequent and careful observation of chick behavior.

**Spot brooding behavior**

With spot brooding, correct temperature is indicated by chicks being evenly spread throughout the brooding area as shown in **Figure 19**. Uneven chick distribution is a sign of incorrect temperature or drafts.

**Figure 19:** Bird distribution and behavior under brooders.



**Temperature too high:**

- Chicks make no noise
- Chicks pant, head and wings droop
- Chicks away from brooder



**Temperature correct:**

- Chicks evenly spread
- Noise level signifies contentment



**Temperature too low:**

- Chicks crowd to brooder
- Chicks noisy, distress-calling



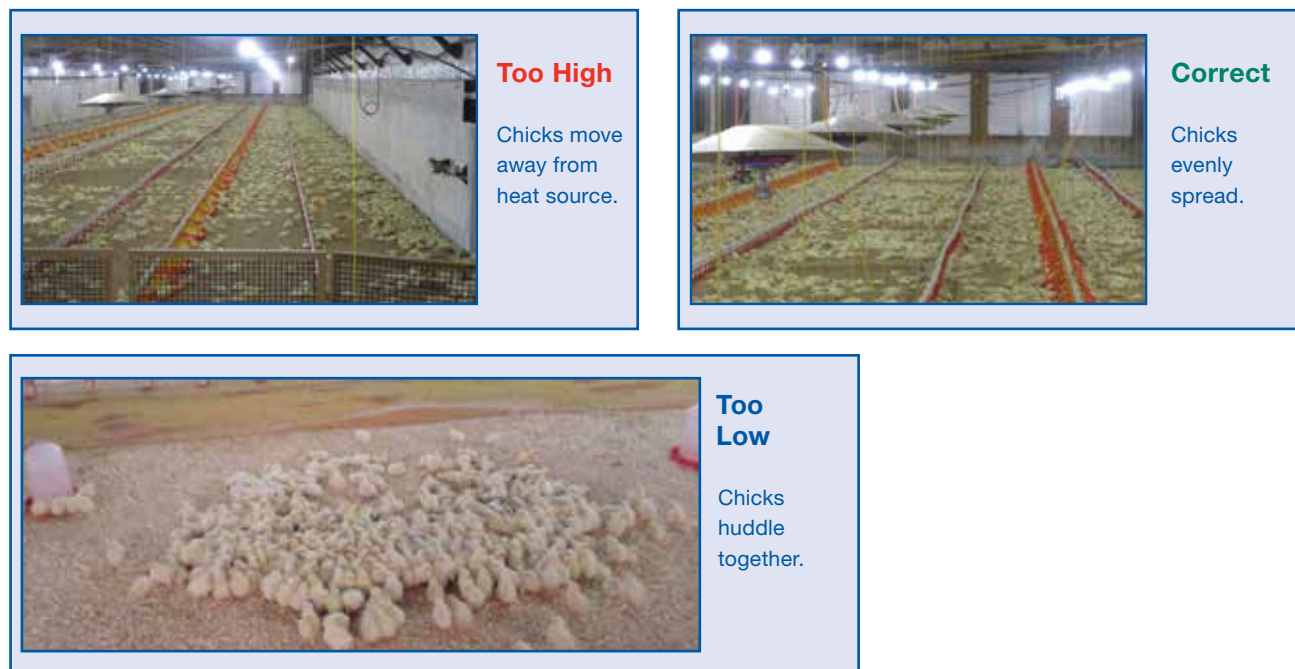
**Draft:**

- Chicks huddling in one area of the surround

**Whole-house brooding**

In whole-house brooding, monitoring chick behavior is less easy, because there are no obvious heat sources. Often, the chicks' vocalizations may be the only indication of distress. Given the opportunity, birds will congregate in areas where the temperature is closest to their requirements. If environmental conditions are correct, chicks will tend to form groups of 20-30, with movement between the groups, and continuous feeding and drinking will occur. Different distributions of chicks in whole-house brooding at different temperatures are given in **Figure 20**.

**Figure 20:** Typical distribution of chicks in whole-house brooding (without chick surround) at different temperatures.



**Air quality**

Poor air quality, in particular high levels of CO<sub>2</sub> and CO (>3000 ppm CO<sub>2</sub> and >10 ppm CO), will impact chick behavior. If air quality is poor, chicks may become lethargic and stop eating. It is important to monitor chick behavior for these signs, making routine measurements of air quality and adjusting ventilation accordingly.



- Closely and frequently observe chick behavior.
- Adjust house environment in response to chick behavior.

**Chick Start Assessment**

**Crop fill**

In the period immediately after the chicks are first introduced to feed and water, they are expected to eat, drink and fill their crops. Assessment of crop fill at key times after placement is a useful means of determining early appetite development and checking that all chicks have found feed and water. Crop fill should be monitored during the first 48 hours, but the first 24 hours are the most critical. An initial check 2 hours after placement will indicate if chicks have found feed and water. Subsequent checks at 8, 12, 24 and 48 hours after arrival on the farm should also be made to assess appetite development. Samples of 30-40 chicks should be collected at three or four different locations in the house (or per surround where spot brooding is used). Each chick's crop should be felt gently. In chicks that have found feed and water, the crop will be full, soft and rounded (**Figure 21**). If the crop is full, but the original texture of the crumb is still apparent, the bird has not yet consumed enough water. Target crop fills are given in **Table 5**.

**Figure 21:** Crop fill after 24 hours. The chick on the left has a full, rounded crop while the chick on the right has an empty crop.




**Table 5:** Target crop fill assessment guidelines.

Time of Crop Fill Check After Placement	Target Crop Fill (% of Chicks with Full Crops)
2 hours	75
8 hours	>80
12 hours	>85
24 hours	>95
48 hours	100

If crop fill is below target then the following need to be considered:

- Was the house pre-warmed adequately prior to chick placement?
- Were air temperature, litter temperature and RH% correct at chick placement?
- Is light intensity optimal in the brooding area?
- Are ventilation rates correct and uniform throughout the house?
- Do chicks have unrestricted access to feed and water?
- Is at least 90% of the floor covered with paper with feed on?
- Is feeding and drinker space correct?
- Have feed amounts been replenished in small frequent amounts?



**Other Useful Information Available**

Broiler Breeder Management How To: *Assess Crop Fill*

Aviagen Video: *Managing Flock Uniformity - Chick Start*

Aviagen Video: *Managing Flock Uniformity - Crop Fill*

**Vent temperature**

Measuring vent temperature is a good way of determining if environmental conditions are correct for the chicks. In the first 4 to 5 days after hatch, vent temperature should be 39.4 to 40.5°C (103 to 105°F). Vent temperature should be measured on at least 10 chicks from at least five different locations in the house for the first 4 to 5 days after placement. Particular attention should be paid to cold or hot areas of the house (e.g. walls or under brooders). To take vent temperature, gently pick up the chick and hold it so that the vent is exposed, put the tip of the thermometer onto the bare skin of the vent and record the temperature (**Figure 22**). Vent temperature should not be taken on chicks with wet or dirty vents.



**Figure 22:** Taking chick vent temperature.



Monitoring the body temperature of chicks from different areas of the transport vehicle during unloading (five chicks from one box taken from the rear, middle and front of the vehicle) at the farm can provide useful information about uniformity of temperature and environmental conditions during transport and chick condition upon arrival.



#### Other Useful Information Available

Hatchery How To: *Check Your Chicks are Comfortable*



- Monitor crop fill during the first 48 hours after chick placement.
- Achieve good early crop fill. If target levels of crop fill are not being achieved then something is preventing the chicks from feeding and drinking, and action must be taken to resolve this.
- Measure vent temperature for the first 4 to 5 days after placement to ensure it is maintained at the ideal of 39.4 to 40.5°C (103 to 105°F).

## Equipment and Facilities

Optimal flock welfare and performance can only be achieved if the correct amount of floor and feeder space and number of drinkers for bird age and size are given throughout the life of the flock.

### Stocking Density

Stocking density, in part, determines the biological output of the flock. Increases in stocking density must be accompanied by appropriate adjustments in environment and management conditions to prevent reductions in biological performance.

Recommended stocking densities during rear are given in **Table 6**. The range of figures quoted represents the variation in conditions from tropical (lower densities) to temperate (higher densities) climates and are intended as a guide.

Actual stocking density will depend on:

- Local legislation.
- Climate and season.
- Type, system and quality of housing and equipment; particularly ventilation.
- Quality Assurance/certification requirements.

**Table 6:** Recommended stocking densities during rear (from 10 days onwards).

Rearing 10-105 days (2-15 weeks)	
Males Birds/m <sup>2</sup> (ft <sup>2</sup> /bird)	Females Birds/m <sup>2</sup> (ft <sup>2</sup> /bird)
3-4 (2.7-3.6)	4-8 (1.4-2.7)

Prior to 10-21 days of age, progressively increase bird floor space allowances until the levels given in **Table 6** are reached.

When determining the appropriate stocking density, take into account the actual available bird space. For example, day-old to depletion housing systems can incorporate equipment during the rearing stage such as nest boxes, which will reduce the available bird floor area.



- Make sure that each bird has adequate floor space for the environment. If the environment and/or housing conditions experienced by the bird are not optimal, reduce stocking density.
- Follow the local legislation or codes of practice.
- If stocking density is increased, then ventilation, feeders and drinkers must also be increased appropriately.
- When calculating floor space, make sure necessary reductions are made for any equipment in the bird area.

### Feeding Space

Bird uniformity and performance will be negatively affected if there is not enough or too much feeding space for the number of birds in the house. Recommended feeding space for males and females is given in **Table 7**.

**Table 7:** Recommended feeding space.

MALES		
	Feeding Space	
Age (days)	Track Feeder cm (in)	Pan Feeder cm (in)
0-35 days	5 (2)	5 (2)
36-70 days	10 (4)	9 (3.5)
71-105 days	15 (6)	11 (4)

FEMALES		
	Feeding Space	
Age (days)	Track Feeder cm (in)	Pan Feeder cm (in)
0-35 days	5 (2)	4 (2)
36-70 days	10 (4)	8 (3)
71-105 days	15 (6)	10 (4)

Track and pan feeder lines should be positioned a minimum of 1 m (3.3 ft) apart to allow uniform and unobstructed bird access to the feeder (**Figure 23** and **Figure 24**). The distance between pan feeders within a line (from center to center) should be a minimum of 0.75 m (2.5 ft). Male feeders must be a minimum of 0.6 m (2.0 ft) away from an outside wall.

**Figure 23:** Uniform distribution of females around a track feeder when adequate feeder space is given.



**Figure 24:** Uniform distribution of males around a pan feeder when adequate feeding space is given.



- Bird uniformity will be negatively affected if feeding space and/or bird distribution is not correct.
- Ensure there is enough feeding space for the number of birds in the house.
- Spacing between feeders should allow the birds easy access.

### Feeding Management

The first step in feeding management is to install the correct number of feeders, providing adequate feeding space so all birds can eat simultaneously (**Table 7**). This step provides uniform feed distribution and prevents overcrowding at feeders. Feed distribution must be observed everyday by experienced personnel.

Where track feeding or pans are used, birds should be gradually introduced to the automated system from 8 days of age onwards. This process should be completed over a 2-3 day period, during which time the amount of feed in the automated feeding system should be gradually increased so that birds become accustomed to the noise of the feeders and associate this with feeding. During this transitional period, manual feeding by hand should continue.



If more than one feeder track is used, then tracks should operate in opposite directions. All feed should be distributed to each population within 3 minutes. If feed distribution is a problem, distribution time can be reduced by placing a supplementary bin, with sufficient feed to fill half of the track, halfway round the feeder loop.

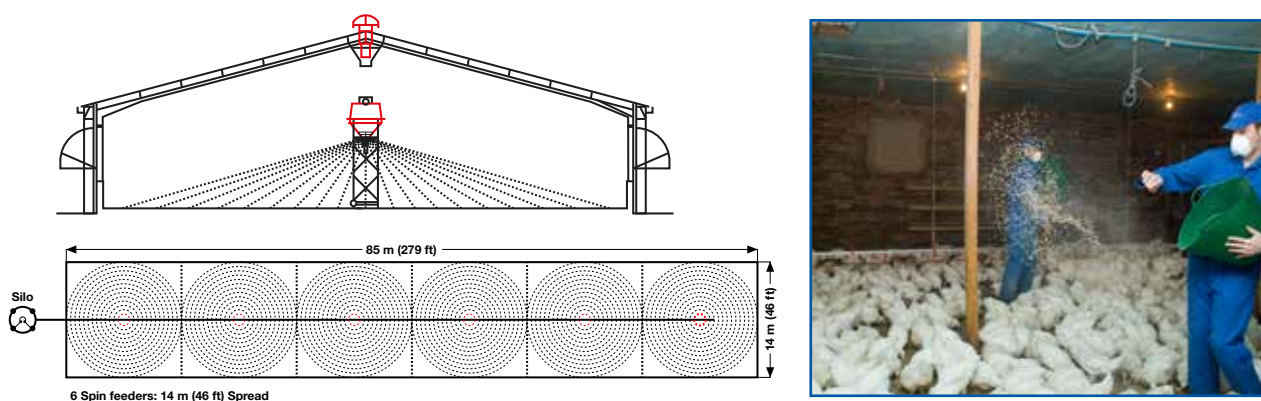
Pan feeders provide good feed distribution if managed properly. Pan feeding systems remain charged (full of feed) at all times to allow the system to work correctly and pan feeders must be checked regularly to make sure that all pans are receiving feed and that lines remain charged.

Feed depth, distribution time and clean-up time should be monitored routinely at several points around the house. This is to ensure that feed distribution is correct, that all birds have access to the feeders at the same time, and that the whole feeding system is being filled correctly. It is best practice to distribute feed in the dark.

Feeder height should be adjusted regularly with bird age and growth. Correct feeder height at a given age should minimize feed spillage, optimize bird access, and prevent the feeders from becoming contaminated with litter.

Floor feeding (**Figure 25**) is an increasingly popular alternative to tracks and pans. This method offers rapid and even distribution of feed over a wide area and can improve flock uniformity, litter condition and leg health.

**Figure 25:** Floor feeding using either spin feeders or hand broadcasting.



For floor feeding, pen population size should be no more than 1000-1500 birds (depending on the pen shape and spinner type). Having feed of good physical quality is particularly important with floor feeding and a pellet with 2.5 mm (0.094 in) diameter and 3-4 mm (0.125 in) in length should be used. For floor feeding, the transition to pellet feeding must be well managed. Crumb should be fed on feeder trays on the floor until approximately 14 days of age. Crumb and pellet should be mixed and fed on the floor/feeder trays for at least 2 days before birds are given 100% pellets at around 16 days of age when mechanical spin feeding begins.



#### Other Useful Information Available

Ross Note: *Floor Feeding for Optimal Uniformity*

No matter which feeding system is used, adjustments to feed provision must be made when problems (such as birds becoming overweight, underweight or worsening flock CV%/uniformity) are detected. As the flock increases in age and body weight, feed increases must support the greater nutrient requirements of the heavier birds.

Ideally, feed should not remain on the farm for more than a week. Feed bins should always remain covered and be in good condition to prevent water entry. Any feed spills should be cleaned up promptly.

Use a standard weight to check the accuracy of the feed scales daily before use. Save a sample of feed from each delivery and store it in a cool, dry place. If a problem develops, the feed can then be analyzed.

A visual assessment of every feed delivery should be made. The feed should be assessed on its physical quality, color, appearance, and smell. For mash, check that there is good distribution of raw materials throughout the feed.

Physical quality of the feed is important and levels of fines should not exceed 10% for pellets/crums or 25% for mash. Increased levels of fines will have a negative impact on performance. The level of fines within a feed can be measured using a feed shaker sieve.



**Other Useful Information Available**

Aviagen Video: *Feed Sieve Demo*



- Feed distribution should take a maximum of 3 minutes.
- Manage the transition to automated feeding systems carefully.
- Ensure good pellet quality when using floor feeding.
- Monitor feed quality.
- Avoid storing feed for more than 7 days.
- Make adjustments to feed intake when necessary.

**Drinker Space and Height**

Recommended drinking space post-brooding is detailed in **Table 8**. When adequate drinker space is provided, bird distribution around the drinkers will be uniform (**Figure 26**).

**Table 8:** Recommended post-brooding drinking space requirements during rearing.

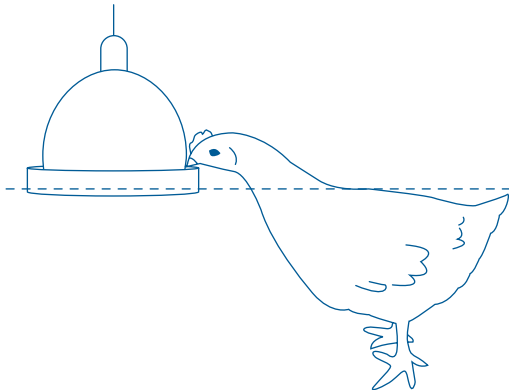
Type of Drinker	Drinker Space
Bell drinkers	1.5 cm (0.6 in)
Nipples	8-12 birds/nipple
Cups	20-30 birds/cup

**Figure 26:** Uniform bird distribution around drinkers when adequate drinker space and correct height is provided for bell, nipple, and nipple with cups.



Check the height of round bell drinkers daily and gradually adjust so that the base of each drinker is level with the birds' backs by approximately 18 days onwards (**Figure 27**).

**Figure 27:** Correct height of bell drinker.



In the initial stages of brooding, the nipple lines should be placed at a height at which the bird is able to drink. The back of the chick should form an angle of 35-45° with the floor while drinking is in progress. As the bird grows, the nipples should be raised so that the back of the bird forms an angle of approximately 75-85° with the floor and so that the birds are stretching slightly for the water (**Figure 28**).

**Figure 28:** Correct height of nipple drinker.



Birds should be reared on the same drinking system as will be used in production.

### **Drinker management**

Birds should have unlimited access to a clean, fresh water supply at all times. Any reductions in water intake by the bird or increased water loss affecting litter conditions can have a significant effect on the lifetime performance of the flock.

Water fit for human consumption is likely also to be fit for parent stock. Water from bore holes, open water reservoirs or poor quality public supplies can cause problems for bird performance and health. Details of water quality criteria for poultry are given in the section on *Health and Biosecurity*. A total water quality test should be completed at least once a year (more often if there are perceived water quality issues). Where bacterial counts are high the cause must be established and rectified as soon as possible. Treatment with chlorination (to give between 3 and 5 ppm) may be required to reduce bacterial load.

Where open-sourced drinkers (such as supplementary chick drinkers or round bell drinkers) are used, bacterial contamination can increase rapidly. Therefore, regular and frequent cleaning is needed, especially with young chicks during the brooding stage.

Water consumption measurement is a useful means to monitor system failures (feed and water) and health, and for tracking bird performance. Water intake varies with feed intake and at 21°C (69.8°F), birds should consume a minimum water-to-feed intake ratio of 1.6:1 (depending upon drinker type and environmental conditions).

Birds will drink more water at higher ambient temperatures. Water requirement increases by approximately 6.5% per degree centigrade over 21°C (69.8°F). In tropical areas, prolonged high temperatures can double daily water consumption.



**Other Useful Information Available**

Broiler Breeder Management How To: *Measure Nipple Flow Rate*



- Birds should have continual access to fresh, clean, drinkable water.
- The measurement of water consumption by metering is a vital daily management practice.
- Check and adjust drinkers daily.
- Test the water supply regularly for bacteriological and mineral contaminants and take any necessary corrective action.

**Introduction of Perches**

It is good management practice to install perches during the rearing period in order to train and stimulate females in nesting behavior (avoidance of floor eggs). Adhere to local legislation and Codes of Practice, but as a minimum, there should be sufficient numbers of perches to provide 3 cm (1.2 in) per bird or sufficient perch space to allow 20% of the birds to roost. Perches should be placed in the females' rearing pens from 28 days of age. **Figure 29** illustrates typical perch systems used for training.

Installing perches during rear is also a useful management tool for training males in situations where water is positioned on the slats.

**Figure 29:** Perch systems used for training.



**Other Useful Information Available**

Best Practice in the Breeder House: *Transfer (Rear and Move)*

## Best Practice in the Absence of Beak Treatment

Beak treatment, introduced as an aid to prevent damage and mortality as a result of pecking in the 1970s, is now being phased out in many areas.

Beak treatment does not prevent pecking; it merely lessens the impact of pecking should it occur. Pecking is a complex behavioral issue that is the result of re-directed scratching and foraging behavior. As such, the application of appropriate best practice management is key. In areas where beak treatment is no longer permitted, the following management strategies should be followed:

1. **Good Stockmanship:** Attention to detail and knowing what is normal and therefore what is abnormal for a flock ensures that potential problems will be detected early and can be dealt with before they develop further.
2. **Rear:**
  - Provide environmental enrichment; the provision of environmental enrichment (such as bales of alfalfa hay or straw, or pecking blocks) no later than 14 days of age will promote and stimulate foraging and scratching behavior.
  - Follow recommended feeding and drinking space advice.
  - Consider the use of metal rather than plastic feeders; metal feeders have a natural blunting effect on the beak.
  - Spin feeding encourages foraging and may also have a natural blunting effect on the beak. If floor feeding, litter depth should not exceed 2-4 cm (1-2 in).
  - Follow recommended lighting intensities; achieving uniform light distribution is key. Lighting in rear must be dimmable.
  - Adhere to recommended stocking densities; higher stocking densities may increase the potential for pecking issues to occur, particularly if feeding and drinker space is not adhered to.
  - Good quality, friable litter must be available from placement. Friable litter will encourage foraging and scratching behavior. If required, actively manage litter to keep it friable.
  - Provide a consistent draft-free environment that provides the correct temperature and adequate fresh air to encourage positive behavior and maintain bird welfare. Correct ventilation will also help to maintain litter quality.
3. **Lay:**
  - Consider the use of metal feeders.
  - Provide continued environmental enrichment until birds are in production.
  - Complete transfer as quickly and efficiently as possible to reduce the challenges that the birds face at this time and so that changes to the environment are minimal. Ensure birds can find feed and water easily and quickly upon arrival.
4. **Nutrition:**
  - Provide adequate nutrition at all ages. In particular, avoid deficiencies in sodium, protein and essential amino acids (especially methionine and cysteine), as well as dietary trace minerals (zinc and selenium).
  - Consider implementing strategies to increase eating-up time; feed higher fiber, lower energy diets during rear. Any reduction in dietary energy must be accompanied by appropriate changes in nutrient levels to ensure that the energy-to-nutrient ratios remain the same. Feeding a coarse mash will also increase eating-up time.

If pecking issues do occur, immediate action must be taken to rectify the problem. The development of feather sucking or a lack of feathers in the litter can be one of the first indications of a problem and if either of these issues are seen, immediate action must be taken to prevent the problem from becoming worse. Any corrective management strategies should be applied in combination to achieve the most benefit.

- Reduce light intensity or add red light. This is only an option if light intensities are not low to begin with.
- Send diets away for analysis to rule out dietary deficiency. Implement other management strategies to help combat problems while waiting for any results to come back.
- Provide additional or a change in environmental enrichment.
- The addition of sodium bicarbonate (1 kg/1000 liters, 3.3 lb/220 gal) water or liquid methionine (0.05 g or 0.002 oz/bird per day) may be beneficial.



### Other Useful Information Available

*Management of Broiler Breeders in the Absence of Beak Treatment*



## Grading to Manage Uniformity

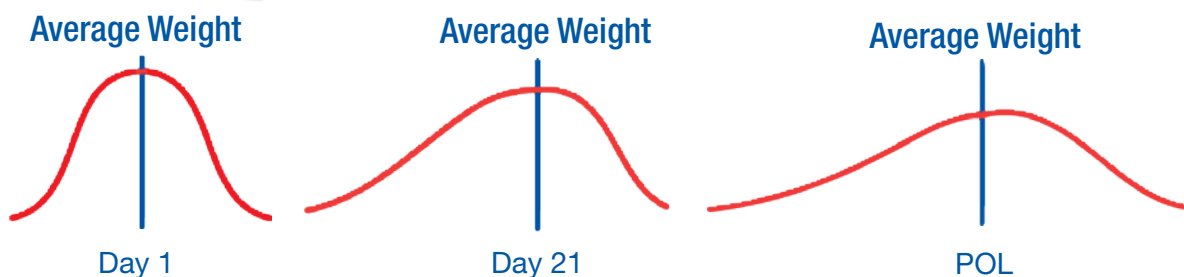
### Objective

A uniform flock is easier to manage than a variable one; birds in a similar physiological state will respond more uniformly to management factors. The purpose of grading, therefore, is to sort the flock into 2 or 3 sub-populations of different average weights (physiological state) so that each group can be managed in a way that will result in good whole flock uniformity at point of lay (POL).

### Principles

Within populations there is always natural variation, even at day-old. At placement, flock body weights should follow a normal distribution with a low variation (see Day 1 in **Figure 30**). As birds grow, the variation within a flock will increase further due to the different responses of individual birds to factors such as vaccination, disease, differing competitiveness for feed, etc. (**Figure 30**). This increased variation reduces overall flock performance and makes flock management much more difficult.

**Figure 30:** Example of how flock variation changes over time as a result of natural variation when **no** flock grading has occurred.



In order to create a uniform flock, smaller, lighter birds as well as larger, heavier birds should be identified, penned and managed separately. The benefits of doing this are illustrated in **Figure 31**.

**Figure 31:** Example of how flock variation changes when the flock is graded at 28 days.



Minimizing variation within the flock makes flock management easier, as all birds will respond in a similar way to management factors such as light stimulation and increased feeding.

## General Procedures for Grading

Grading is best carried out when the flock is between 28 and 35 days (4 and 5 weeks) of age. If completed later than this, the time available to resolve issues (ideally by 63 days) is reduced, and the procedure is less effective.

Grading is based on the variation in body weight within a flock at the time of grading. A highly variable flock at time of grading with a large spread of body weights around the average will need to be split into more sub-populations than a less variable flock (see **Table 9** for more information). After grading, each sub-population should be managed separately according to its weight with the aim of bringing all populations back to target by POL.

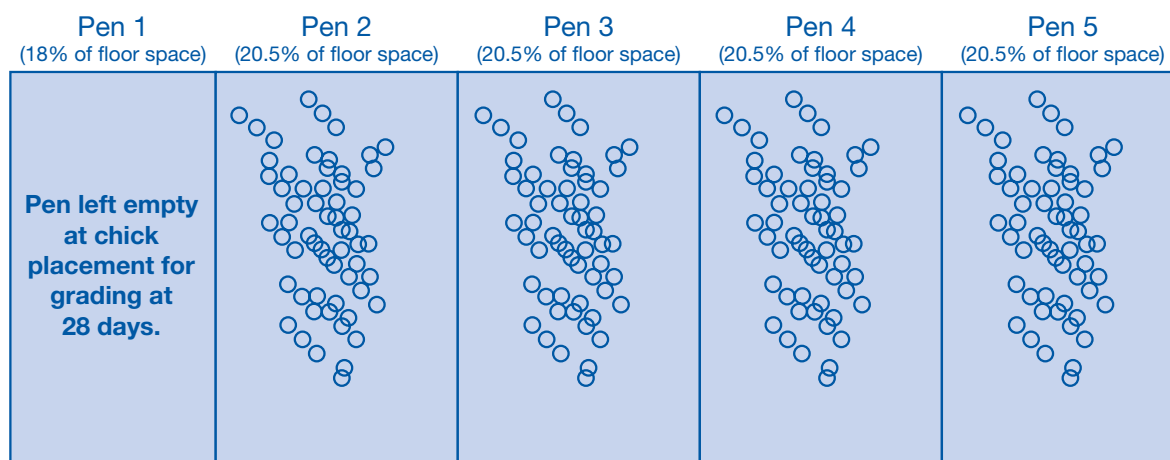
Variation within a flock can be measured in two ways:

1. **Coefficient of variation (CV%)** – this measures the variation (spread) of body weights within the flock; the **lower** the CV%, the less variable the flock is.
2. **Uniformity (%)** – this measures the evenness of body weights within a flock; the **higher** the uniformity, the less variable a flock is.

Grading can be done using either measurement of flock variation and methods for doing so are given in more detail below. However, there are some general principles for grading that are the same no matter which strategy is used to grade a flock:

1. The actual grading procedure will largely depend on the farm/house design and management practices (e.g. flexibility of pen arrangements and feeding systems) and the variation in body weight within the flock at 28-35 days. Ideally, house set-up at placement should account for the need to grade later in the flock with at least 1 pen left empty at placement (**Figure 32**).

**Figure 32:** Pre-grade house set-up for 2-way grade with adjustable penning.



2. Space allocated for both male and female flocks must be capable of being divided into 2 or 3 pens/populations. Where the entire population of a house is to be graded within that house, then ideally 1 or 2 adjustable partitions will be required to allow the flock to be segregated.
3. Prior to grading, a sample of birds from the population should be weighed and the variation within the flock (as measured by CV% or uniformity) measured. Flock CV% or uniformity can then be used to determine the grading cut-off points (the number and average weight of birds that will be graded into each population). Aviagen's preference is to use electronic scales that record and count individual weights, and automatically calculate the CV% and uniformity of the population. If electronic scales are not available and weights are recorded manually, please refer to the example given in **Appendix 4**. A minimum sample of 2% of the population (or 50 birds, whichever is greater) should be weighed. If more birds than this are caught, they should all be weighed to avoid selective bias.
4. After grading, it is important to re-weigh a sample of birds from each pen or population (a minimum of 2% or 50 birds, whichever is greater) and establish the average body weight, the variation around that average as measured by CV% or uniformity and number of birds for each pen. After grading, the variation in body weight within the graded populations will have improved.

- It is essential that stocking density and feeding and drinking space are maintained in line with recommended guidelines in the graded populations. Each population should have its own dedicated feeding system. Where this is not possible, supplementary feeding systems must be installed to allow even distribution of feed and adequate feeding space per bird.
- The body weights from graded populations should be plotted against targets and the profiles redrawn where necessary to bring birds back on target by 63 days (9 weeks) of age. Adjustment in feed levels should be based on deviation in body weight from target.

**Grading Using CV%**

**Houses with adjustable penning**

From each pen/population, a random sample of birds (a minimum of 2% or 50 birds whichever is greater) should be caught in a catching pen and weighed.

**Table 9** provides the grading cut-off points (i.e. the percentage of birds that will be graded into each population), according to flock CV%. These cut-offs apply specifically when **adjustable penning** is available in the house. When CV% is below 10, grading is not required.

**Table 9:** Grading cutoffs when using CV%.

Flock Uniformity CV%	Percentage in Each Population after Grading			
	2 or 3-way grade	Light (%)	Normal (%)	Heavy (%)
10-12	2-way grade	20	~ 80 (78-82)	0
12-14	3-way grade	22-25	~ 70 (66-73)	5-9
>14	3-way grade	28-30	~ 58 (55-60)	12-15

**Figure 33** gives an example of a printout produced from electronic scales and shows how it can be used to establish the cut-off points for grading when a 3-way grade is required.

**Figure 33:** Example of a print-out from an electronic scale for a 3-way grade with **adjustable penning**.

CURRENT DATA METRIC	
TOTAL WEIGHED:	197
AVERAGE WEIGHT:	0.446
DEVIATION:	0.06
C.V. (%):	<b>13.5</b>
Band limits	Total
0.320 to 0.339	4
0.340 to 0.359	7
0.360 to 0.379	10
0.380 to 0.399	12
0.400 to 0.419	14
0.420 to 0.439	16
0.440 to 0.459	27
0.460 to 0.479	30
0.480 to 0.499	28
0.500 to 0.519	22
0.520 to 0.539	13
0.540 to 0.559	8
0.560 to 0.579	6

CURRENT DATA IMPERIAL	
TOTAL WEIGHED:	197
AVERAGE WEIGHT:	0.98
DEVIATION:	0.13
C.V. (%):	<b>13.5</b>
Band limits	Total
0.705 to 0.747	4
0.750 to 0.791	7
0.794 to 0.836	10
0.838 to 0.880	12
0.882 to 0.924	14
0.926 to 0.968	16
0.970 to 1.012	27
1.014 to 1.056	30
1.058 to 1.100	28
1.102 to 1.144	22
1.146 to 1.188	13
1.190 to 1.232	8
1.235 to 1.276	6

Flock details	kg	lbs
Age	28 days	28 days
Target weight	0.450	0.99
Average weight	0.446	0.98
Total birds weighed	197	197

Based on this flock sampling data, a 3-way grade is required as detailed below; i.e. flock CV% is between 12 and 14 (see **Table 9**).

Cut off points and number of birds in each group:

	% of Birds	No. of Birds*
Light Birds	24	47
Average Birds	69	136
Heavy Birds	7	14

\* No. of birds = (% birds ÷ 100) x total birds weighed

The **light** graded population will be approximately 24% of the entire flock. Of the 197 birds weighed, the lightest 24% (or 47 birds) are in the weight range of 0.320 to 0.419 kg (0.71 to 0.92 lbs). A **light** birds will therefore be a bird weighing **less than or equal to 0.419 kg (0.92 lbs)**.

Using the same process, the cut-off weights for the average and heavy populations can also be determined.

The **average** population will therefore be in the weight range of **0.420 to 0.539 kg (0.93 to 1.19 lbs)**.

The **heavy** graded population will be any birds that is **0.540 kg (1.19 lbs) or heavier**.



If a 2-way grade is required (i.e. flock CV% is lower than 12), the cut-off points provided in **Table 9** and the information from the electronic scale print out can be used to establish the cut-off weights for the 2 graded populations in the same way as was done in the example for a 3-way grade above.

**Houses with fixed penning**

In houses with non-adjustable or fixed penning, the pens are set in place at the start of the flock in each house. Pens will be equally divided across the house and the graded populations will need to be split evenly across the available pens. For example, if there are four separate pens, 25% of the population will need to be housed in each pen; grading cutoffs and cut-off weights will need to be adjusted to account for this. See **Appendix 4** for more information.

**Grading Using Uniformity**

**Houses with adjustable penning**

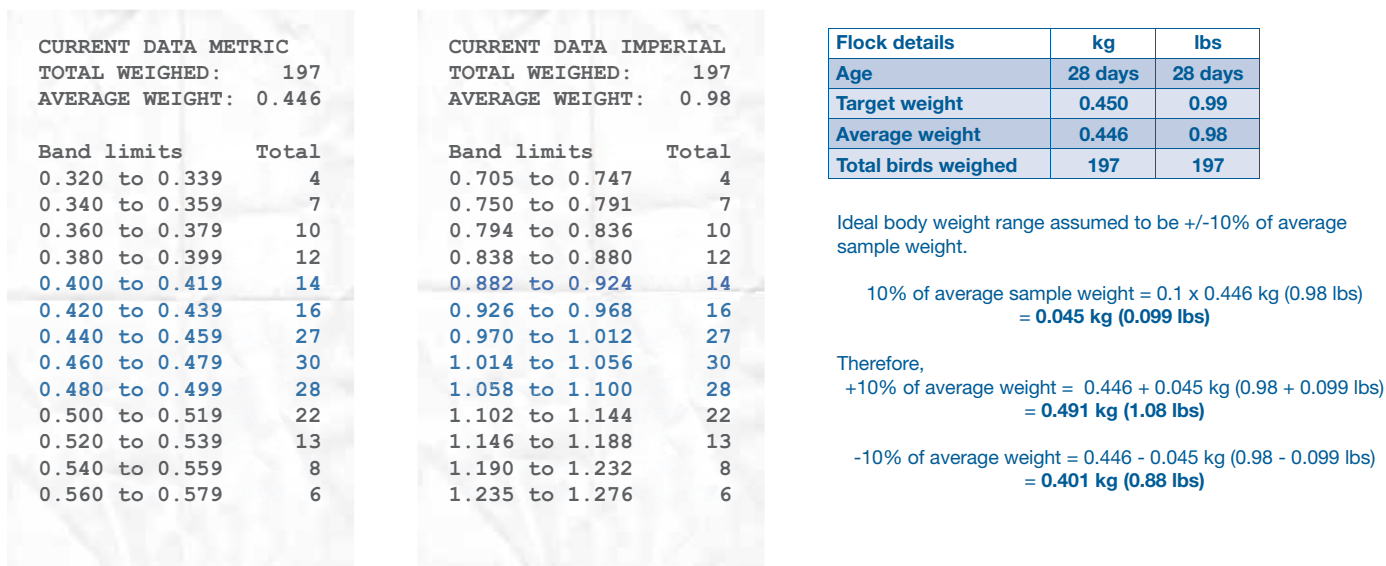
The uniformity of a flock is expressed as the percentage of birds that fall within a given range (ideally +/- 10%) around the average body weight of the flock. The higher the number of birds that fall within this body-weight range, the more uniform the flock and the less grading it will require (**Table 10**). Grading is not required when flock uniformity is 80% or above.

**Table 10:** Grading cutoffs when using uniformity to grade.

Uniformity	2 or 3-way Grade
65% - 80%	2-way grade
65% or lower	3-way grade

An example of how to use uniformity to complete a 3-way grade of a flock is given in **Figure 34**.

**Figure 34:** Example of a print-out from an electronic scale for a 3-way grade using uniformity % and when adjustable penning is available.



115 birds out of 197 weighed are within the weight range that is +/- 10% of the average body weight (0.401-0.491 kg [0.88-1.08 lbs]), highlighted blue in the electronic print-out. Uniformity is therefore **58%**.

As uniformity is less than 65%, a 3-way grade is required (see **Table 10**).

**Light** birds will be those that weigh **0.401 kg (0.88 lbs) or less** (-10% of the average sample weight).

**Average** birds will be those that weigh **0.402-0.490 kg (0.88-1.08 lbs)**.

**Heavy** birds will be those that weigh **0.491 kg (1.08 lbs) or heavier** (+10% of the average sample weight).

If a 2-way grade is required (i.e. flock uniformity is 65% or greater), the information from the sample weighing can be used to establish the cut-off weights for the two graded populations in the same way as was done in the example for a 3-way grade above.

### **Houses with fixed penning**

If grading using fixed (non-adjustable) penning is the only option available, it will be necessary to adjust the grading cutoffs and cut-off weights to account for pen size. This adjustment will need to ensure that the correct number of birds are placed in each pen so as to maintain recommended stocking density. For more information please refer to **Appendix 4**.



- Grade males and females at 28 days (4 weeks).
- It is recommended to use electronic rather than manual weigh scales.
- A successful grading will improve the variability of the graded populations to be better than that of the original population and ideally to a CV% of around 8 or a uniformity of above 80%.
- Each population should be re-weighed and counted to confirm the average body weight and uniformity/CV% so projected target body weights and feeding rates can be determined.
- Inaccurate counting of birds after grading may lead to incorrect feed quantities being given.
- Each population is best served by its own dedicated feeding system. Where this cannot be provided, supplementary feeding must allow even distribution of feed and adequate feeding space per bird.
- Ensure that stocking density, drinking and feeding space are consistent with the recommended guidelines after grading; this is especially important where pen size is adjusted during grading.

## **Flock Management After Grading (Post 28 Days)**

After grading, the flock must be managed so that graded populations achieve target weight in a uniform and coordinated manner.

Although the grading of birds into individual pens is a key management strategy, post-grading management to maintain bird uniformities within graded pens is of even greater importance and particular detail must be paid to the management of individual populations from 35 days onward. If population sizes in lay are likely to be larger than they were in rear, birds will have to be mixed at transfer. Here it is especially important that management after grading results in the birds converging to a common target body weight by the expected age of transfer.

### **Post-grading Feed Levels**

Post-grading feed levels should be adjusted to individual pen and graded bird body weights to bring each population gradually back to the target line.

- Feed levels must be recalculated on a weekly basis calculating for changes in livability.
- Base on individual pen body-weight gain and bird numbers.
- Feed levels should NEVER be reduced.
- For light bird pens, feed levels should remain the same as the week prior to grading for 1 week post-grading. Reduced competition from heavier birds after grading means an initial increase in feed is not required.
- Weekly feed increments will need to be:
  - « smaller for heavy bird pens.
  - « greater for light bird pens.
- Do not hold feed at a constant level for longer than two consecutive weeks.

Unexpected changes in body weight may be due to incorrect feed allocation, changes in feed composition/ingredients or a change to a different feed type and must be investigated immediately.

**Post-Grading Body-Weight Management (Up to 63 Days of Age)**

At grading, the flock will have been divided into 2 or 3 populations, depending on the original CV% or uniformity. For each graded population, the aim is to achieve the target body weight uniformly within the period during which skeletal development is taking place (i.e. before 63 days of age). After 28 days of age, the weekly body weights of each population must continue to be monitored and feed allocations adjusted as necessary to allow the required body-weight targets to be met.

**Under target weight birds (light population)**

Where the average body weight after grading for a population or pen is below target body weight by more than 100 g (0.22 lbs), the objective is to redraw the body-weight curve so that target body weight is achieved by 63 days (Figure 35). For the first week after grading, the light population should be held on the same feeding volume as that prior to grading (i.e. do not increase feed levels). Body weight will be increased due to the reduced competition from the larger birds. Subsequent appropriate increases in feed should then be based on the deviation from target body weight.

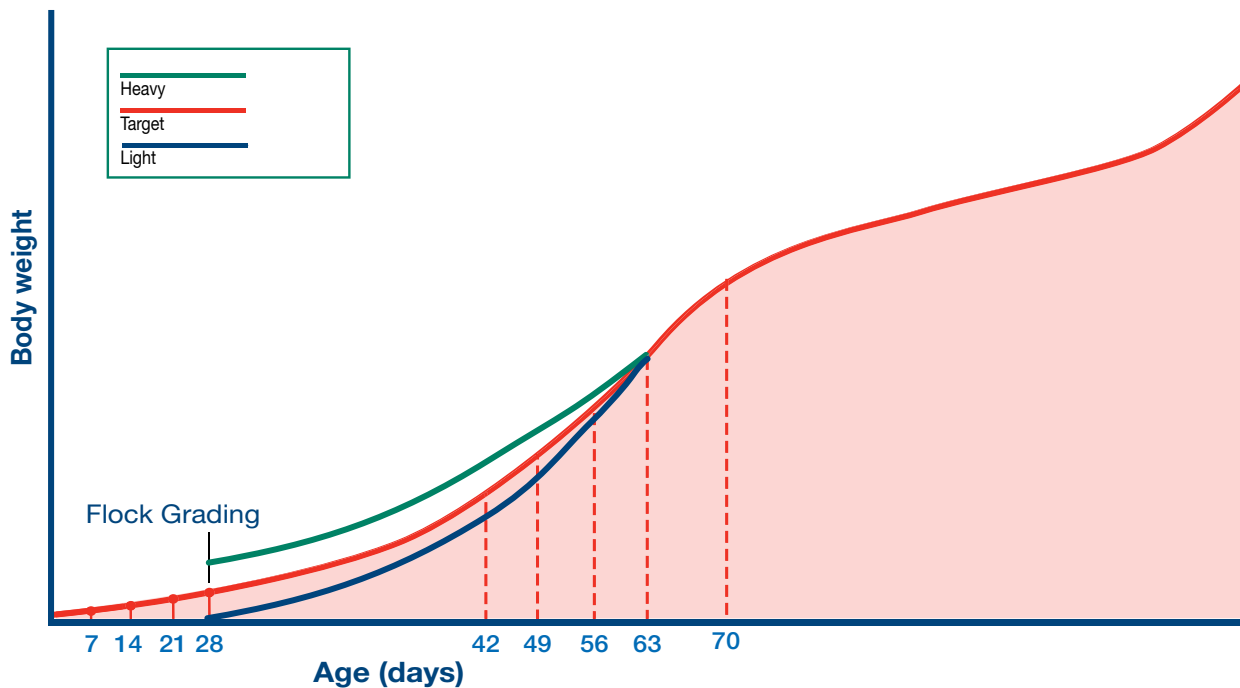
**On target weight birds (average population)**

The aim is to continue to keep birds on target (Figure 35).

**Over target weight birds (heavy population)**

These are birds that are greater than 100 g (0.22 lbs) over the target body weight. Here the body-weight curve should be redrawn to reduce growth so that birds are gradually brought back onto target by 63 days (Figure 35). Feed levels should never be reduced, but it may be necessary to reduce the next feed increment or delay the next feed increase in order to achieve the revised body-weight profile.

**Figure 35:** Redrawing of future body-weight targets up to 63 days (9 weeks) of age.



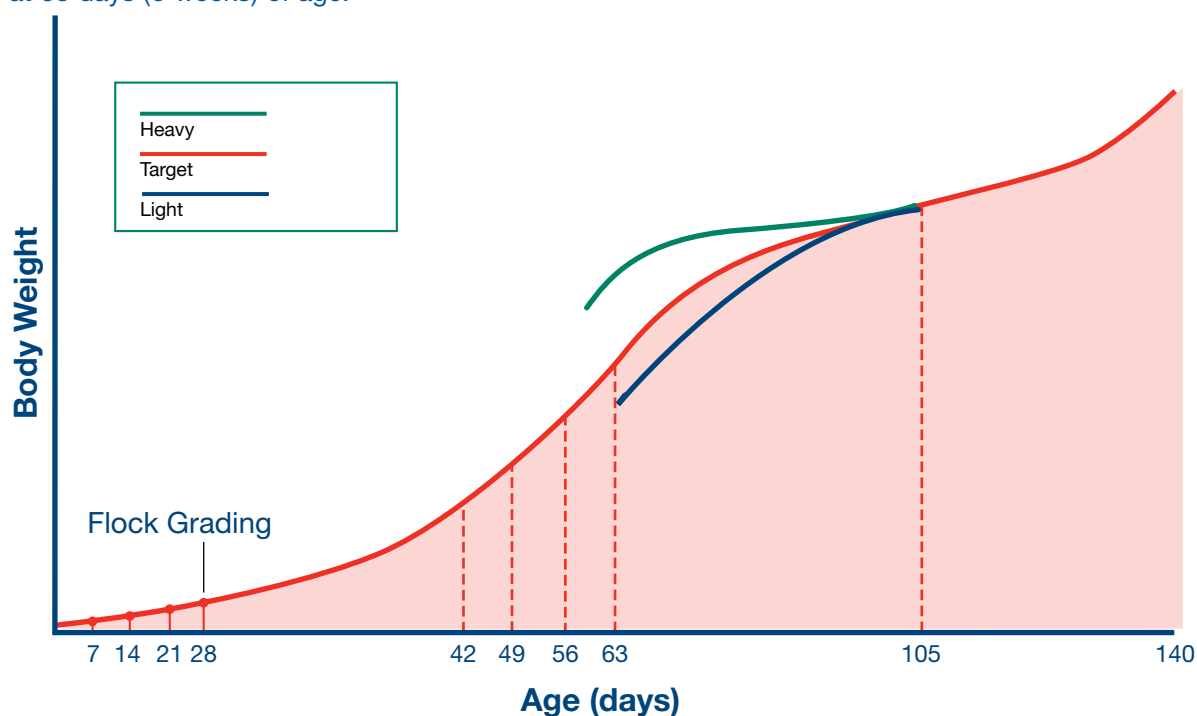
**Post 63 Days Redrawing of Future Body-Weight Profiles**

At 63 days of age, the weight of the population in relation to the target should be re-assessed. Populations that are of similar weight and feed consumption can be combined at this age.

**Under target weight birds (light population)**

If birds remain under target at 63 days (9 weeks), the target should be redrawn so that birds are brought back onto target profile gradually (Figure 36), achieving body weight by 105 days. Feed levels should be increased or the next feed increase brought forward to achieve this.

**Figure 36:** Redrawing of future body-weight targets when average body weight is below, on, or above target at 63 days (9 weeks) of age.



**On target weight birds (average population)**

The aim is to continue to keep birds on target (Figure 36).

**Over target weight birds (heavy population)**

If birds remain overweight at 63 days (9 weeks of age), the target should be redrawn so that birds are brought back onto target profile gradually (Figure 36), achieving body weight by 105 days. Birds should be fed the level of feed required to achieve the revised target profile.

**Table 11** identifies further key areas associated with incorrect population management post-grading.



- Continue weekly body-weight monitoring.
- From 63 days, redraw the target weights of any population that is above/below target body weight to bring them back on target by 105 days of age.
- Before mixing any pens, ensure body weight and consumption per bird are similar.

### Alleviation of Body-Weight Problems

If the average body weight differs from target body weight by +/-100 g (0.22 lb) or more during rear, re-weigh a sample of birds. If the weights are accurate, see the information in **Table 11** and consider the following:

Underweight prior to 105 days, consider the following in **future** flocks:

- Remain on starter feed for longer.
- Feed a higher nutrient quality starter.
- A longer daylength can be provided until 21 days (3 weeks) of age to help stimulate feed intake and improve body-weight gain.

Underweight prior to 105 days, consider the following in current flocks:

- Initiate the next feed increase earlier and consider increasing the amount if necessary, until body weight is brought gradually back to target.
- See **Figure 35** and **Figure 36** for examples of such corrective action.

Overweight prior to 105 days:

- Do not reduce feed lower than the current feeding level.
- Reduce the next feed increment, e.g. 2 g (0.07 oz) per bird instead of 4 g (0.14 oz) per bird.
- Delay the next feed increase.
- Check to see if the energy level of the diet is higher than expected.
- See **Figure 35** and **Figure 36** for examples of such corrective action.

Any changes made to alleviate body-weight problems should be made gradually, ensuring positive average body-weight gains are made each week.

**Table 11:** Key areas of incorrect population management post-grading.

Item	Comment	Actions	Supporting Information
Stocking Density	Number of birds per m <sup>2</sup> /ft <sup>2</sup> per bird. Bird stocking density must remain equal within each graded pen and follow recommendations.	Adjustable pens - Increase or decrease pen area to maintain the recommended stocking density for age.	Stocking Density Table - Table 6, Page 31.
		Fixed pens - Adjust bird numbers within each pen to maintain the recommended stocking density for age.	Stocking Density Table - Table 6, Page 31.
Light Intensity	Lux/Foot Candle (fc). Light intensity should be uniformly distributed throughout each pen at bird level and avoid shaded areas.	<p>Ensure all light bulbs are set at an equal and uniform distance from the floor.</p> <p>Ensure all bulbs are in good working order, are clean and emit the same level of intensity.</p> <p>Avoid the use of unidirectional light bulbs (old style LED bulbs or spot lights).</p> <p>Avoid the use of low-intensity (high flicker rate) fluorescent tubes.</p>	Environmental Requirements - Table 23, Page 135.
Feeding Space	Birds per feeder/cm (in) of feeding space per bird. Available feeding space should be maintained at recommended levels and adjusted for bird age and number throughout the rearing period and into production.		
	Pan feeders (loop or straight line)	<p>Ensure adequate distance between feeder pan centers (min 75 cm/2.5 ft).</p> <p>Each graded population should have its own dedicated feeding system where possible to allow accurate feed amounts to be given. If not then the whole house population should be fed to the lowest feed amount per bird (usually the large bird population) and any extra feed needed should be added by hand and evenly distributed between all feeders.</p> <p>Follow recommended feeding space per bird throughout rear.</p> <p>Ensure feed allocation settings per pan (feed volumes) are equal, to allow a uniform distribution of feed throughout the house.</p> <p>Distribute feed in the dark where possible to allow instant access to feeders when lights are turned back on.</p> <p>Adjust number of pans in adjustable penning if bird numbers change.</p> <p>Ensure feeder height is correct and adjusted for age.</p> <p>Ensure feed is distributed within 3 minutes.</p>	Feeding Space Table - Table 7, page 31.



Item	Comment	Actions	Supporting Information
<p><b>Feeding Space</b></p>	<p>Track feeders</p>	<p>Ensure recommended feeding space per bird is maintained throughout the rearing period.</p> <p>For adjustable penning, adjust track length for any changes in bird number per pen.</p> <p>Ensure correct depth of feed to allow uniform feed distribution along whole length of track.</p> <p>Each graded population should have its own dedicated feeding system, where possible, to allow accurate feed amounts to be given. If not then the whole house population should be fed to the lowest feed amount per bird (usually the large bird population) and any extra feed needed should be added by hand and evenly distributed along the available track.</p> <p>Ensure feed is distributed within 3 minutes.</p> <p>Distribute feed in the dark where possible to allow instant access to feeders when the lights are turned back on.</p> <p>Ensure feeder height is correct and adjusted for age.</p>	<p>Feeding Space Table - Table 7, page 31.</p>
	<p>Floor/spin/hand feeding</p>	<p>Ensure any spin feeders are calibrated correctly to allow correct amount of feed per bird.</p> <p>Check floor area is covered uniformly with pellets to allow all birds to eat uniformly and that stocking densities within each pen are correct for age of birds.</p> <p>Ensure pellets are of good durability for floor feeding.</p> <p>Ensure litter depth is within recommendations.</p>	<p>Stocking Density Table - Table 6, page 31.</p> <p>Litter Depth - Section 1, page 19.</p> <p>House Preparation and Layout</p> <p>Pellet Durability - Section 1, page 32.</p> <p>Feeding Management</p>
<p><b>Drinker Management</b></p>	<p>Number of birds per drinker (nipple or bell)</p>	<p>All birds should have unrestricted access to water.</p> <p>Recommended number of birds per nipple or round bell drinker should be adhered to throughout the rearing period within each pen.</p> <p>A minimum water-to-feed ratio of 1.6-2.0 liters of water to feed should be followed depending on house and external environmental temperatures.</p> <p>If pen sizes need to be adjusted for bird numbers, ensure bell and nipple drinker numbers are adjusted to maintain the correct number birds per drinker.</p> <p>Ensure drinker heights are correct and adjusted for age.</p> <p>Ensure drinker flow rates are correct for age of bird and requirements.</p>	<p>Drinker Table - Table 8, page 34.</p> <p>How To Measure Flow Rates - Section 1, page 35.</p> <p>Drinker Management</p>
<p><b>Ventilation</b></p>	<p>Calculated for body weight and stocking density</p>	<p>Ensure uniform air flow through all pens by using equal number of inlets open per pen and uniform distribution of inlets throughout house.</p> <p>Use correct number of fans for appropriate air volume calculated for biomass in house and pens.</p>	<p>Ventilation Rates Table - Table 22, page 122.</p> <p>Environmental Requirements</p>

Notes

Dotted lines for note-taking.

## Section 2 - Management into Lay (15 Weeks to Peak Production)

### From 105 Days (15 Weeks) to Light Stimulation

#### Objective

To ensure a healthy, stable development into maturity with minimal variation in the onset of sexual maturity of the flock and to prepare the flock reproduction.

#### Principles

Correct body-weight gains during this period will ensure a smooth and uniform transition to sexual maturity and egg production in the females, and will support uniform and optimum physical condition and fertility in males.

#### Management Considerations

For the management of young birds through to adulthood, achieving the correct stocking density and feeding and drinker space as birds reach sexual maturity is key to their individual development and the development of the flock. It will assist uniformity within the flock, reduce variation in sexual maturity (both within and between males and females) and help to maintain optimum physical condition and reproductive fitness of the flock. After 140 days (20 weeks) of age, stocking density needs to be reduced, and feeding and drinker space increased, to account for increased bird size and additional equipment (such as nest boxes) in the house during lay.

#### Stocking Density

Stocking density influences biological output. Recommended stocking densities for male and females from 15 weeks of age to depletion for both males and females are given below (**Table 12**). The figures given are a guide; actual stocking densities may vary from those recommended depending on:

- Welfare regulations.
- Economics.
- Environment.
- Actual available floor space, drinker and feeder space.

Environment (ventilation) and management conditions (feeding and drinker space) must be appropriate for the stocking density to ensure optimal performance.

**Table 12:** Recommended stocking densities from 15 weeks of age to depletion.

	Stocking Density Birds/m <sup>2</sup> (ft <sup>2</sup> /bird)	Stocking Density Birds/m <sup>2</sup> (ft <sup>2</sup> /bird)
	15-20 weeks	20 weeks to depletion
Male	3-4 (2.7-3.6)	3.5-5.5 (2.0-3.1)
Female	4-8 (1.4-2.7)	

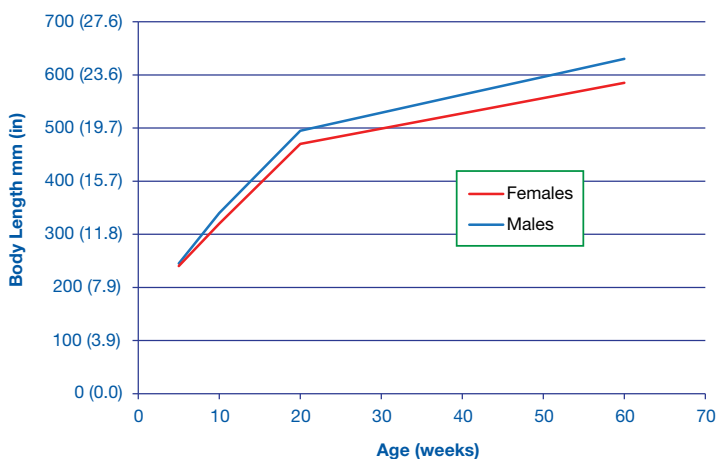
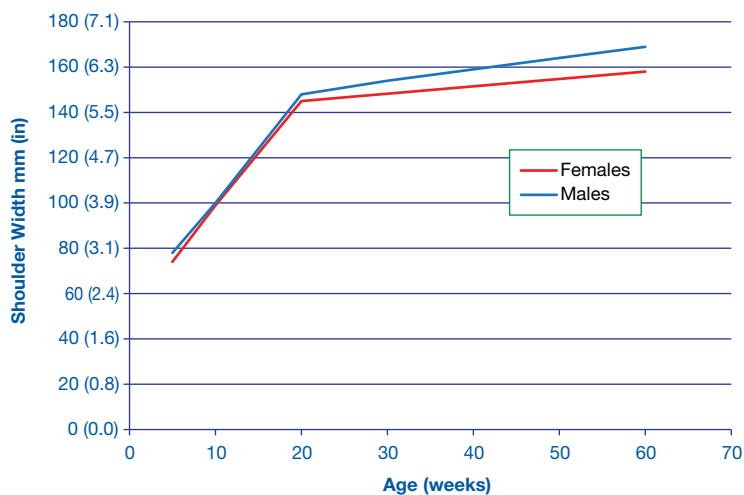
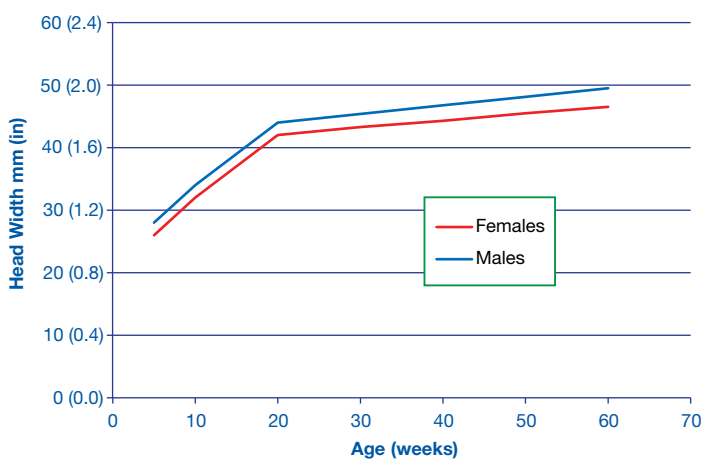
#### Feeder and Drinker Space

Recommended feeder and drinker spaces for both males and females are given in **Table 13**. **Figure 37** shows how bird body size (head width, shoulder width and length) change with age for both males and females. Feeder and drinker space must allow for these changes in bird size with age.

**Table 13:** Recommended feeder and drinker space from 15 weeks of age to depletion.

	Age	Feeder		Drinker		
		Track cm (in)	Pan cm (in)	Bell cm (in)	Nipple	Cups
Male	15-20 weeks	15 (6)	11 (4)	1.5 (0.6)	8-12 birds/nipple	20-30 birds/cup
	20 weeks to depletion	20 (8)	13 (5)	2.5 (1.0)	6-10 birds/nipple	15-20 birds/cup
Female	15-20 weeks	15 (6)	10 (4)	1.5 (0.6)	8-12 birds/nipple	20-30 birds/cup
	20 weeks to depletion	15 (6)	10 (4)	2.5 (1.0)	6-10 birds/nipple	15-20 birds/cup

**Figure 37:** Changes in head width, shoulder width and body length with age in males and females.





- Follow recommended allowances for stocking density and for feeding and drinker spaces, and adapt ventilation accordingly.
- Ensure increases in available floor space and feeding and drinking spaces are given at the recommended ages.

### Target Weight

Management focus during the period from 15 weeks (105 days) of age to light stimulation is the same for both males and females. The aim is to maintain a uniform flock of birds that are on the target body-weight profile so that the transition to sexual maturity occurs smoothly, uniformly and at the desired age. This is done by following the recommended increases in weekly energy intake and body weight.

Regular monitoring and recording of body weight and uniformity are vital management tools during this period. Development of secondary sexual characteristics, such as increased pin bone spacing in females and increased facial color in both sexes, is a good indicator of flock progress in sexual development.

Failure to meet required weekly incremental gains in body weight between 15 weeks of age and light stimulation is a common cause of poor performance, leading to:

- Delayed onset of lay.
- Poor initial egg size.
- Increased percentage of rejected and misshapen eggs.
- Increased number of infertile eggs.
- Increased broodiness.
- Loss of uniformity of body weight and sexual maturity.
- Reduced peak production.
- Loss of sexual synchronization between males and females.

Where average body weight is under target (defined as body weight being more than 100 g [0.22 lbs] below target weight) at 105 days (15 weeks) of age, the body-weight curve should be redrawn and the birds gradually brought back to target body weight (by giving appropriate increases in feed) by the time of light stimulation (**Figure 38**).

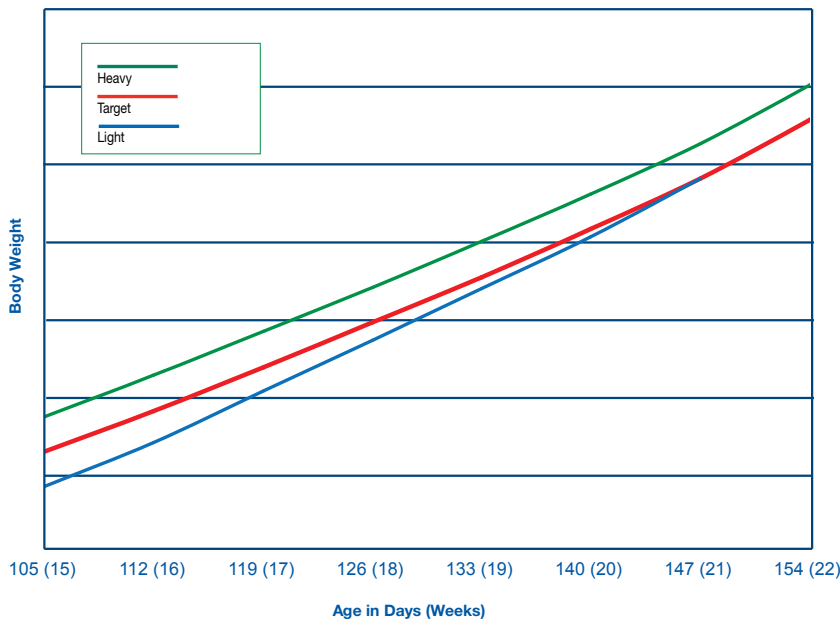
Flocks that are over-fed and exceed target body weights between 15 weeks of age and light stimulation will commonly exhibit:

- Early onset of lay.
- Increased incidence of double yolks.
- Reduced hatching egg yield.
- Increased feed requirement through lay.
- Reduced peak, persistency and total eggs.
- Reduced male and female fertility throughout life.
- Increased incidence of peritonitis and prolapse.
- Loss of sexual synchronization between males and females.

Where average body weight is over target (100 g [0.22 lbs] or more above target weight) at 105 days (15 weeks), the body-weight curve should be redrawn parallel to target (**Figure 38**). Note that birds must not be brought back to target if they are overweight at this stage; this will result in a loss of condition, which will have a negative impact on egg production.

Once birds are overweight, it is a matter of managing the flock closely to minimize the damage (minimize the negative effect on production and uniformity). For underweight birds, it is possible to increase feed levels and weight gain. Ideally, neither situation should occur and close monitoring is central to effective management.

**Figure 38:** Redrawing of body-weight profiles if females are under (light) or over (heavy) target weight at 15 weeks (105 days) of age.



- Ensure flock body weight follows the target profile.
- Maximize uniformity of body weight and sexual maturity.
- Redraw target body weight if necessary (if the flock is under or overweight at 15 weeks/105 days). Grow birds that are underweight to regain target by light stimulation. Set a new target for overweight birds.

**Feed Type and Energy Level**

Inadequate nutrient supply as birds reach sexual maturity is a frequent cause of loss of uniformity. Careful management is required when feed type is changed (e.g. from grower to pre-breeder) and the farm manager should be aware of any changes in energy and available nutrient content between feed types or formulas. When a change in feed type occurs, feed provision must be altered accordingly; if energy content of the feed is reduced with a change in feed type, feed provision will need to be increased and vice versa.



- Be aware of any changes in energy or available nutrient content between feed type and formulas and alter feed provision accordingly to account for this.

**Lighting**

In the period from 15 weeks of age to light stimulation, it is important that a constant 8 hours of light is maintained so that birds can respond appropriately to the light stimulation when it occurs (see section on *Lighting*).



- Follow recommended lighting programs.



**Rear and Move Facilities**

It is common practice to move birds from rearing facilities to separate laying facilities. The age at which transfer to the laying facilities occurs can vary depending on housing type. For light-proof laying facilities, transfer should not occur later than 21 weeks (147 days) of age. For open-sided laying facilities, transfer may need to be later than 21 weeks, depending on season and natural daylength, but should never occur after 23 weeks (161 days) of age. Regardless of what type of housing is used, transfer should not be completed before 18 weeks (126 days). It is recommended that males are moved before females (at least 1 day before) to allow them to find the feeders and drinkers. Females should be transferred onto the slats so they can easily find food and water (**Figure 39**). Environmental conditions in the lay facilities must be equalized with those in rear prior to the males being moved.

An additional increase in feed quantity (up to 50% more) on the day before and the day of transfer will help compensate for the challenges of moving. Birds should not be fed on the morning they are due to be moved. Feeders in the laying facility should be fully charged so that birds have immediate access to feed on arrival. Feed levels should be returned to normal on the first or possibly second day after transfer. The exact amount of extra feed given and the length of time over which it is given after transfer will depend on season, environmental temperature, and transport duration.

Environmental and equipment differences must be minimized between rear and lay facilities. It is important that feeding space is not reduced and that lighting programs and biosecurity are synchronized between rearing and laying houses.

After transfer, check crop fill of both males and females (**Figure 40**) to ensure they are finding feed and water. Crop fill should be assessed on the day of transfer, 30 minutes after the first feed and then again 24 hours later. A random sample of at least 50 females and 50 males should be assessed. If crop fill is found to be inadequate (ideally all birds assessed should have a full crop) the reason for this should be investigated and resolved (possibilities include: inadequate feeder space, feed distribution or availability of feed).

**Figure 39:** Transfer of birds onto the slats.



**Figure 40:** Crop fill assessment of broiler breeders after transfer. The bird on the left has an empty crop and the bird on the right has a full crop.



**Other Useful Information Available**

Best Practice in the Breeder House: *Transfer (Rear and Move)*



- Provide extra feed on the day before and the day of transfer.
- Ensure that males and females are finding feed and water and have adapted to separate sex feeding systems after transfer by monitoring feeding behavior and checking crop fill.
- Minimize environmental and equipment differences between rear and lay facilities.

### Day-old to Depletion Facilities

In day-old to depletion facilities where the feeding system is changed between rear and lay, transferring birds to the new feeding system must be managed carefully. New feeders must be introduced so that birds are able to access them and find feed easily. For example, where birds are floor-fed in rear and then transferred to track feeders in lay, the track feeders should initially be set at a low height (low enough to allow the birds to see feed within the feeder) for the first 1-2 days. Check crop fill to determine that all birds have found the new feeders and are managing to access feed.



- Where there is a change in feeding system between rear and lay, manage this transfer carefully by ensuring that birds can easily find and get access to the new feeders.

### Mixing Males and Females

At the time of mixing males and females, additional management techniques are needed. If the males and females mix well, it will benefit flock production and welfare during the entire production period. Therefore, pay attention to mating-up procedures, identification of sexing errors, management of separate-sex feeding and male-to-female ratio.

#### Mating-up

Mating-up should be started from 21 weeks (147 days) of age. Both males and females must be sexually mature before mating-up occurs; an immature male should never be mated with a mature female. A sexually mature male will have a comb and wattles which are well-developed and red in color (**Figure 41**). A sexually mature female will also have a bright red comb and wattles (**Figure 42**). Mating-up should be postponed by 7 to 14 days if sexual maturity is delayed or the birds are to be moved from dark-out rearing to open-sided laying facilities. This postponement will give the birds more time to become sexually mature and give better control over feeding (as males will be bigger, the separate-sex feeding systems will work better).

Where variation exists in sexual maturity within the male population and some males are visibly immature, the more mature males should be mixed with the females first. As an example, if the planned mating ratio is 9.5 to 10% then a possible system of mating-up would be to mix half of the total number of required males (those that are most mature) at 21 weeks, mix a further quarter (again the most mature males) a week later, and then finally mix the remaining males the following week.

If males are more mature than females, then they should be introduced to the females more gradually. For example, mate-up at a ratio of 1 male for every 20 females, then gradually add more males over the next 14 to 21 days to reach the desired mating ratio.

**Figure 41:** An example of a mature young male with a well-developed comb and wattles that are red in color (on the left) and an immature male with an under-developed comb and wattles that are pale in color (on the right).



**Figure 42:** An example of a young female with a well-developed comb and wattles that are red in color (on the left) and an immature female with an under-developed comb and wattles (on the right).



In the period from mating-up until all males have become sufficiently large to be physically excluded from the female feeders (approximately 26 weeks of age), feeding behavior should be carefully monitored (at least twice a week). This is necessary to check that the separate-sex feeding systems are working properly and that feed is being distributed correctly and evenly around the shed.

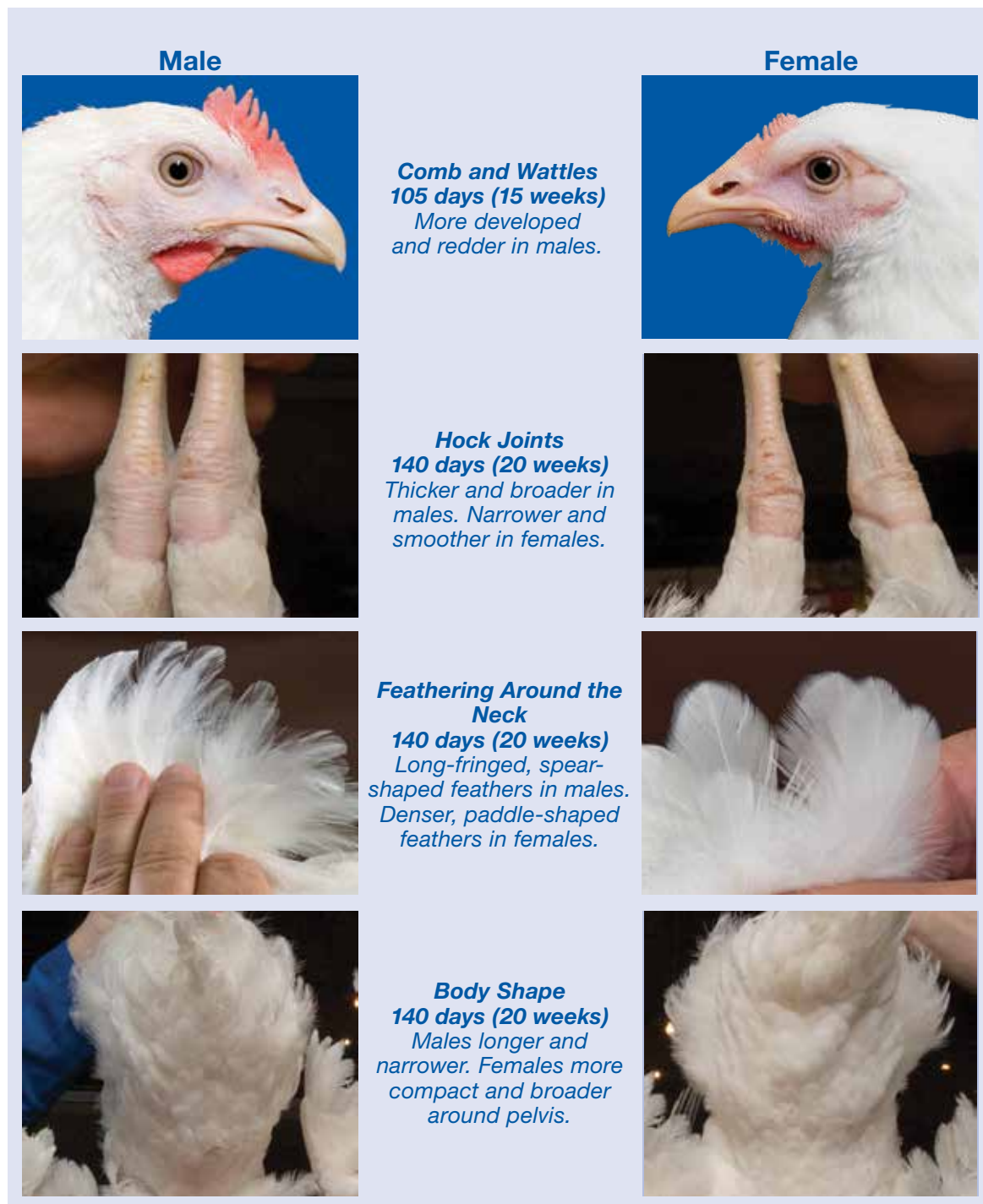


- Ensure both males and females are sexually mature at mating-up.
- Make sure immature males are not mated to mature females.
- Begin mating-up at 147 days (21 weeks).
- Monitor feeding behavior.

**Sexing errors**

Identifying sexing errors (males present in female pens and females present in male pens) can be difficult at early ages, but it is good practice to remove these birds whenever they are identified during the life of the flock. Ideally, all sexing errors should be removed before mating-up. The criteria for doing this are illustrated in **Figure 43**.

**Figure 43:** Criteria for identifying males and females for the resolution of sexing errors.



**Separate-Sex Feeding Equipment**

After mating-up, males and females should be fed from separate feeding systems (Figure 44).

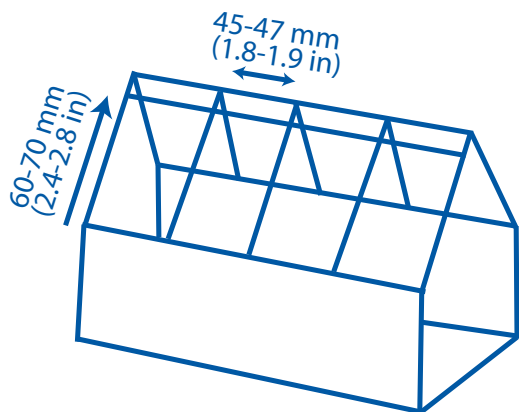
Separate-sex feeding takes advantage of differences in head size between males and females and allows more effective control of body weight and uniformity in each sex. Separate-sex feeding requires especially careful management, and feeding behavior should be monitored regularly throughout lay. At a minimum, feeding behavior should be monitored twice weekly up to 26 weeks of age. Complete exclusion of all males from the female feeders normally occurs around 26 weeks of age. Up to this point some males may still be able to access the female feeding system and steal female feed. Careful monitoring of body weight and feeding behavior is important at this time to ensure that both males and females are receiving enough feed to maintain target increases in body weight. After 26 weeks of age, monitoring of feeding behavior can be reduced to once a week. Feeding equipment must be properly adjusted and maintained; poorly managed and badly maintained feeding equipment gives uneven feed distribution, which is a major cause of depressed egg production and fertility.



**Female feeding equipment**

With track feeding systems, the most effective method of preventing male access to the female feeders is to fit grills (grids or toast racks) to the tracks (**Figure 44**). Males are then excluded from the female feeders because of their greater head width and comb height (see **Figure 37** for changes in head width with age), while female access remains unrestricted. Internal grill width should be 45-47 mm (1.8-1.9 in) and grill height should be 60-70 mm (2.4-2.8 in). The addition of horizontal wires on either side of the apex of the grid will help to strengthen the grill. Grid widths less than 45 mm (1.8 in) will prevent a significant number of the females from feeding and cause reduced performance.

**Figure 44:** Separate-sex female feeding system showing grills (grids or toast racks).



The addition of a plastic pipe in the apex of the grill can be used to further restrict male access (**Figure 45**). This addition is particularly useful from the time of mating-up until physical maturity (approximately 30 weeks of age). After about 33-35 weeks of age, the pipe can be removed. It is important to make sure that the piping is fixed correctly and securely to the apex of the feeder. If not, the piping may sag and restrict female access to the feeder.

**Figure 45:** Separate-sex feeding system for females showing grills and the addition of plastic pipe in the apex.



An alternative to grills are roller bars (**Figure 46**). These are fitted to the track feeding system and the height is adjusted as the birds age. Bar height should start at 43 mm (1.7 in) at mating-up and gradually be increased to 47 mm (1.9 in) by 30 weeks of age.

**Figure 46:** A roller bar system used to restrict male access.



A grill can also be used to prevent access by males to automatic pan feeders or hanging hoppers (tube feeders). With hanging hoppers (tube feeders), feeder movement should be reduced to a minimum.

Daily checks should be made for damage, displacement or irregularity of gaps in the female feeder system. Failure to detect and correct such problems will allow males to steal female feed (**Figure 47**), and effective control over body weight and uniformity will be lost.

**Figure 47:** Males stealing from female feeders.



### Male Feeding Equipment

Three types of feeders are generally used for males (**Figure 48**):

- Automatic pan-type feeders.
- Hanging hoppers (tube feeders).
- Suspended feeder track.

**Figure 48:** Male feeders (from left to right: automatic pan feeders, hanging hoppers, suspended feeder track).





Hanging hoppers (tube feeders) and suspended feed tracks are both suspended from the house roof and feeder height can be adjusted appropriately for the male population. When hanging hoppers (tube feeders) are filled manually, it is important that the same feed quantity is delivered to each hopper and that the hoppers are not tilted to one side. Counterweights beneath tube feeders are useful to reduce movement. Suspended feeder tracks for males have proven successful because feed can be levelled or evened-out within the track, ensuring an even feed distribution.

After feeding, suspended feeders should be raised to deny males further access to the feeders. When feeders are raised, the next day's allocation of feed should be added so that when they are lowered at the next feeding time, males have instant access to feed. It is beneficial to delay male feeding until about 5 minutes after the female feeders have been filled.

It is essential that male feeder height is correctly adjusted so that all males have equal access to feed at the same time, while female access to the feeders is prevented (**Figure 49**). Correct male feeder height is dependent on male size and feeder design, but as a general rule, male feeder height should be in the range of 50-60 cm (20-24 in) above the litter. Care should be taken to ensure that the litter under the feeders is level and any build-up of litter beneath male feeders should be avoided as this will reduce feeder height, allowing females to steal male feed. Daily observation and adjustment at feeding time is necessary to ensure that male feeder height remains correct. As male numbers decline, the number of male feeders should also be reduced to ensure that feeding space remains optimal. Care should be taken to avoid giving too much feeding space to males, as the more aggressive males will over-consume, male body-weight uniformity will decline, and a loss in reproductive performance will occur.

**Figure 49:** Correct male feeder height.



- Distribute feed with the lights off.
- Provide separate male and female feeding systems. Female feeding systems should have grills fitted to prevent male access and male feeders must be raised to a height that will allow only males to access them.
- Observe feeding behavior daily to ensure both sexes are feeding separately, male feeders are at the correct height, and feeding space and feed distribution are adequate.
- Make daily checks for damage, displacement or irregularity of gaps in the female feeder system.

# Management of Females Post Light Stimulation Until 5% Production

## Objective

To bring the female into lay by stimulating and supporting egg production using feed and light.

## Principles

Females need to be grown to the target body-weight profile and with the recommended lighting program (see section on *Lighting*) so that the flock comes into production in a uniform way.

## Management Considerations

For equipment, stocking density, and feeder and drinker space recommendations, see **Table 12** and **Table 13** (Section: *15 Weeks to Peak Production*).

Regular feed increases (at least weekly) are essential for appropriate body-weight gain, uniform sexual maturity, fleshing, and timely onset of lay. Lighting programs should be implemented on schedule to support and stimulate females during this period. The first light increase should be given around 147 days (21 weeks) of age, but the exact timing will depend primarily on body weight and flock uniformity. If the flock is uneven (CV% greater than 10), light stimulation should be delayed by approximately 1 week (see section on *Lighting*).

Water should be freely available. The breeder layer feed should be introduced from 5% hen-day production at the latest to ensure that the birds receive the correct amount of nutrients (such as calcium) to support egg production.

Any problems with feed, water, or disease at this stage can have devastating effects on the onset of production and subsequent flock performance. It is therefore wise to monitor and record uniformity, body weight, and feed clean-up time, responding quickly to any decrease in uniformity, any change in feed clean-up time, or any reduction in body-weight gain.

Nest boxes should be opened just before the anticipated arrival of the first egg (likely 10-14 days after the first light increase is given). Opening nest boxes too early will reduce the females' interest. Dummy eggs can be placed in nests to encourage the birds to lay in them. Where automated systems are used, the egg gathering belts should be run several times each day, even before the arrival of the first egg, so that the birds become accustomed to the sound and vibration of the equipment.

The spacing of the birds' pin (pubic or pelvic) bones should be measured to determine the state of sexual development of the female. When measuring pin bone spacing, it is also a good idea to check the amount of abdominal fat covering the pin bones. For further information on monitoring pin bone spacing, refer to the section on *Assessment of Bird Physical Condition*.



- Achieve target body-weight by concentrating on correct weekly incremental feed increases and resultant bird gains.
- Follow the recommended lighting program.
- Monitor flock uniformity, body weight and feed clean-up time, and respond quickly to any issues.
- Provide unlimited access to clean, good-quality water.
- Change from grower to first breeder feed at 5% production at the latest.
- Open nest boxes just before anticipated arrival of first egg.
- Measure pin-bone spacing.

## Floor Eggs

Floor eggs represent a loss in production and a hygiene risk to the hatchery. Appropriate training of birds to lay eggs in the nests will reduce floor eggs. Below are a number of other practices that can reduce the occurrence of floor eggs (**Figure 50**):

- Slat height should be a maximum of 25-30 cm (10-12 in).
- Introduce perches from 28 days (4 weeks).
- Incorporate a suitable alighting/perching rail in nest box design.
- Ensure male and female sexual maturity is synchronized.
- Have uniform distribution of light of between 30 and 60 lux (3-6 fc). Avoid the presence of dark and shaded areas next to walls, corners, and in the areas next to steps and slat fronts. If floor eggs are a particular problem, light intensity may need to be increased above recommended levels.
- Provide correct feeder space for females.
- Follow the recommended lighting program and ensure that light stimulation is synchronized with body weight.
- Where automated systems are used, run the egg-gathering belts several times each day.
- Keep nest boxes closed until just prior to the anticipated arrival of the first egg (**Figure 51**).
- Walk around the house as frequently as possible (at least 6 and up to 12 times a day), picking up any floor eggs. This will prevent floor eggs being laid habitually.
- Set feeder and drinker heights appropriately so that they are not obstacles to nest access.
- Manage early mating ratios to avoid over-mating.
- With manual nests, put 20% at floor level to start. Thereafter, gradually raise them (over a period of 3 to 4 weeks) to the normal height.
- Allow 3.5-4 hens per nest hole for manual nests.
- Allow 40 hens per linear meter (12 birds per linear foot) for mechanical (communal type) nests.
- Ensure environmental conditions are adequate and avoid drafts in the nesting places.
- Set feeding times to avoid the peak of egg laying activity. Feeding time should be either **within** 30 minutes of "lights on" or 5-6 hours **after** "lights on" to prevent birds from feeding when most eggs are likely to be laid.

**Figure 50:** Example of floor eggs being laid next to an automatic nest box.



**Figure 51:** Example of closed nest boxes. Nest boxes will be opened just prior to the anticipated arrival of the first egg.





**Other Useful Information Available**

Best Practice in the Breeder House: *Preventing Floor Eggs*

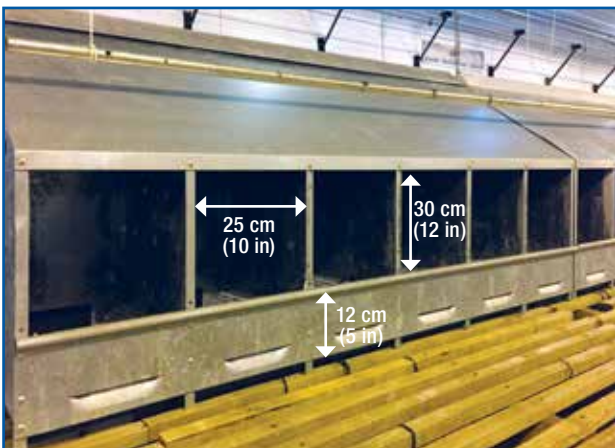


- Attention to detail avoids floor eggs.

**Nest Box Set-up**

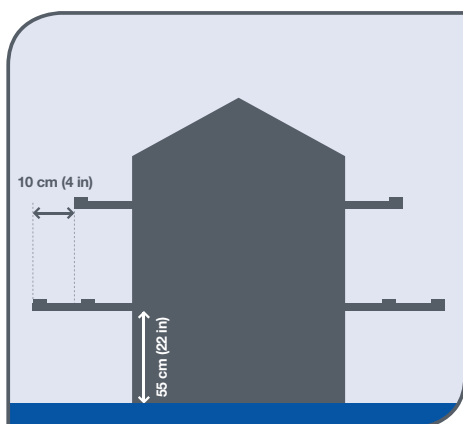
Nest boxes must be set up prior to the onset of lay. The entrance to the nest must be large enough for the hen to enter, turn around and exit comfortably (see **Figure 52**). Nests must have a firm entrance and a solid base and be securely fixed in place.

**Figure 52:** Nest box entrance dimensions.



For manual nest boxes, the lower alighting rail should be no more than 55 cm (22 in) from the floor and it should extend to a minimum of 10 cm (4 in) beyond the rail of the second tier (**Figure 53**).

**Figure 53:** Manual nest box set-up.



# Management of Females from 5% Hen-day Production Until Peak Egg Production

## Objective

To promote and support female reproductive performance throughout the laying cycle.

## Principles

Hatching egg production performance is affected by early egg size, egg quality, and level of peak production. Correct body weight during early lay can be achieved by providing females with feed levels that will meet the increased demands of egg production and growth.

## Management Considerations

For equipment, stocking density, and feeder and drinker space recommendations, see **Table 12** and **Table 13** (Section: *15 Weeks to Light Stimulation*).

Females must continue to gain weight during early lay to maximize egg production and hatchability. Birds should be fed to meet the increased demands of egg production and growth, but overfeeding must be avoided. Birds that receive more feed than required for egg production will not develop an optimal ovarian structure and will gain excess weight - resulting in poor quality eggs, low hatchability, and increased risk of peritonitis and prolapse.

The difference in feed quantity allocated prior to first egg and the target feed level given at peak (see the **Ross Parent Stock Performance Objectives** for more details) allows a feed allocation schedule to be established. Amounts of feed given up to and at peak should then be adjusted for each individual flock depending on:

- Hen-day production.
- Daily egg weight and change in egg weight trend.
- Body weight and body-weight gain trend.
- Feed clean-up time.
- Dietary energy density.
- Operational environmental temperature.
- Degree of body fleshing and fatness.

Responsive management of birds coming into production requires frequent observation and measurement of the production parameters given above. These parameters are not used in isolation but rather in combination to determine whether or not the feed allocation for an individual flock is correct. Both the absolute and trend data should be taken into account. For example, if there is an unexpected change or deviation from target in hen-day production, egg weight, body weight, or feed clean-up time, then feed allocation should be reviewed. However, in order for the manager to make informed decisions on feed quantity, dietary energy content and environment temperature must also be known. The frequency with which each of these parameters should be measured is given in **Table 14**. Monitoring of body weight, daily egg production and daily egg weight is key when determining feed allocations.

**Table 14:** Frequency of observation of important production parameters.

Parameter	Frequency
Egg production	Daily
Increase in egg production	Daily
Egg weight	Daily
Body weight	Weekly (manual) / Daily (automatic)
Body-weight gain	Weekly (manual) / Daily (automatic)
Feed clean-up time	Daily
House temperature (min. and max.)	Daily
Body condition and fleshing	Weekly (and on walk-through)

Feed increases given should be proportional to actual rates of production. Thus, in high-producing flocks, extra feed may need to be given, and feed increases beyond recommended peak feed amounts may be justified. Equally, if egg weight and/or body weight are judged to be markedly below the expected target then feed increases should be advanced. Small but frequent feed increases to peak feeding levels should be used to prevent excessive weight gain. Management requirements for each flock will vary depending on body condition, reproductive performance, environment, equipment, and facilities. An example of how a feeding program can be devised for a particular flock, taking into account flock history, type of housing, feed composition and management constraints is discussed below.



- Monitor and achieve target body weight and body-weight gains.
- Monitor daily egg production and egg weight.
- Stimulate egg numbers from 5% production by giving programmed increases in feed allocation.
- Follow the recommended lighting programs.
- Define the program of feed increases based on feed amount prior to production, dietary energy level, ambient temperature and expected flock productivity.
- Use small but frequent feed increases.

### Feed Clean-up Trends

Feed clean-up time is a useful monitoring practice for ensuring that the flock is getting adequate energy intake. Clean-up time is the time it takes for the flock to eat its daily feed allocation (from when the feeder starts to operate until there is only dust left in the feeder). When the amount of feed being offered is excessive, birds will take longer to consume it. Conversely, when there is not enough feed, birds will consume it more quickly than expected. Many factors affect clean-up time including age, temperature, feed amount, physical feed characteristics, feed nutrient density and composition, and ingredient quality. Therefore, trends (changes) in feed clean-up time are as important as absolute time taken to clean up feed. Monitor and record feed clean-up time trends. If there is a change in clean-up time, possible causes (energy levels not as expected, poor feed quality, health issues, incorrect feeding volumes) should be investigated.

At peak production, feed clean-up time is normally in the range of 2 to a maximum of 4 hours at 19-21°C (66-70°F) dependent on feed physical form (**Table 15**).

**Table 15:** A guide to feed clean-up times at peak production.

Feed Clean-up Time at Peak Production (hours)	Feed Texture
3-4	Coarse Mash
2-3	Crumble
1-2	Pellet



- Monitor feed clean-up times and trends in feed clean-up times and respond to any changes in feed consumption trends.



### Egg Weight and Feed Control

Trends in daily egg weight act as a sensitive indicator of the adequacy of total nutrient intake; inadequate nutrient intake will lead to a fall in egg weight, and excessive nutrient intake will lead to an increase in egg weight. Feed intake should be adjusted according to deviations from the expected daily egg weight profile.

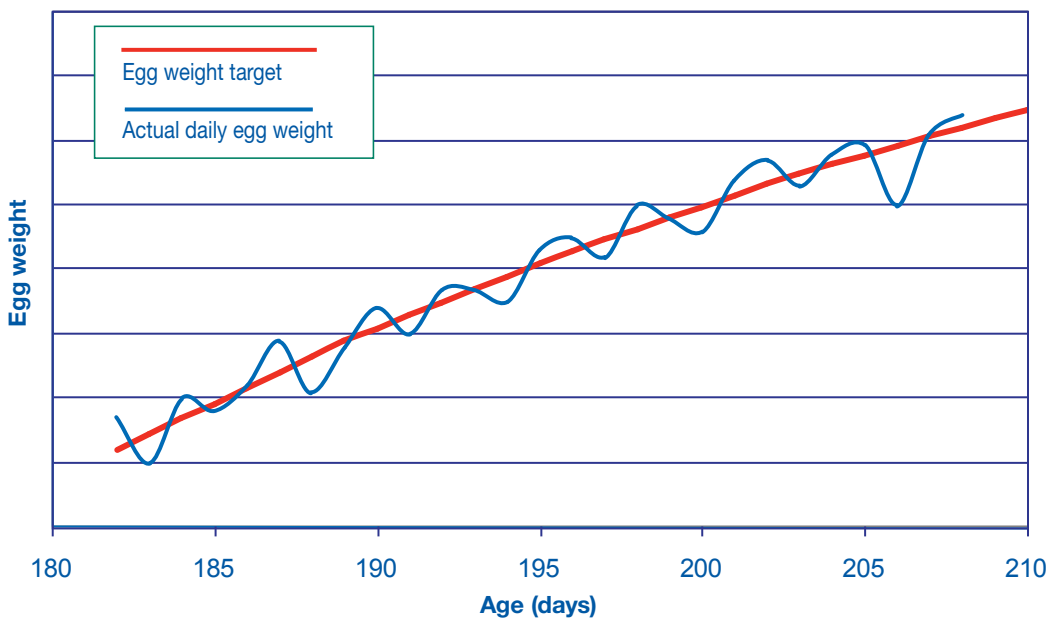
Daily egg weight should be recorded from 10% hen-day production onwards. A sample of 120-150 eggs should be bulk weighed (**Figure 54**) daily. The eggs should be taken from eggs collected directly from the nest at second collection to avoid using eggs laid the previous day. Double yolked, small, and abnormal eggs (e.g. soft shelled) should be rejected and not be weighed.

**Figure 54:** Bulk weighing of eggs.



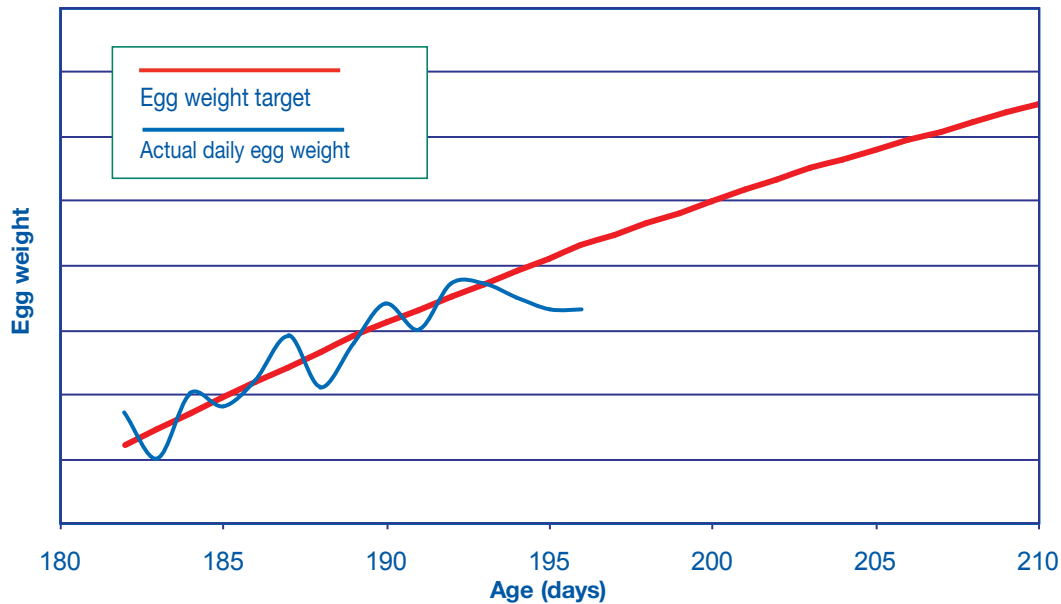
Average daily egg weight is obtained by dividing the bulk weight (weight of eggs minus weight of tray or trays) by the number of eggs weighed. The daily egg weight should then be plotted against target; it is important that the graph scale is large enough to make daily variation clearly visible. In flocks receiving the correct quantity of feed, egg weight will usually follow the target profile. However, it is normal for average egg weight to fluctuate on a daily basis due to sampling variation and environmental influences (**Figure 55**).

**Figure 55:** An example showing normal fluctuations in the daily weight of bulk-weighed eggs.



If the flock is being under-fed, egg size will not increase over a 3-4 day period, and egg weight will deviate from target (**Figure 56**). If peak feed amount has not been reached, the next planned feed increase should be brought forward to correct this. If peak feed has been reached then an additional increase in peak feed amount will be required (3 to 5 g [0.1 to 0.2 oz] per bird).

**Figure 56:** Example of reduction in average daily egg weight over a 3 to 4 day period due to inadequate feed intake.



**Other Useful Information Available**

Broiler Breeder Management How To: *Weigh Eggs*



- Bulk weigh samples of eggs and record average daily egg weight from 10% hen-day production.
- Weigh eggs from the second collection to avoid using eggs from the previous day.
- Monitor daily egg weight trends by plotting against target.
- Respond promptly to falling daily egg weight trends by increasing feed allowance.

# Management of Males Post Light Stimulation Until Peak Egg Production

## Objective

To optimize fertility and ensure persistency of flock fertility.

## Principles

Females require the correct number of males that are in optimal physical condition.

## Feeding Considerations

Control of male body weight during the period between light stimulation and peak can be difficult, as males become progressively excluded from the female feeders. Body condition, average body weight, and body-weight gains should be monitored ideally twice a week during this period to ensure that the males remain in optimal physical condition and that body weight remains on target (see the **Ross Parent Stock Performance Objectives** for more details). Preventing males from becoming over- or underweight is only possible when separate-sex feeding systems are well maintained and managed.

Typically, males become excluded from female feeders from about 22 weeks of age but some males may continue to access the female feeders up until around 26 weeks of age. Frequent visits by personnel at feeding time to observe feeding behavior are essential at this time. Failure to detect when the males are excluded from the female feeders is a common cause of low male body weight and poor physical condition in the pre-peak period and has serious implications for early and late fertility.

Males stealing female feed, particularly when the flock is between 50% hen-day egg production and peak, may lead to males becoming overweight and the females becoming underweight with a consequential marked reduction in peak egg production levels. Monitoring female factors such as daily egg weight and body weight will indicate if this problem is occurring. If males are stealing female feed there will be a shortfall in average daily egg weight trends and female body weight, and then subsequently egg production will drop.

### Underfeeding

Underfeeding of males can occur during the early stages of production after mixing of males and females. This is because mating behavior at this stage is very active and the male bird has not yet reached physical or physiological maturity so nutrient requirements are high. Males will become dull and listless, showing reduced activity and less frequent crowing if they are being underfed. If these symptoms are missed and the condition progresses, the comb and wattles become flaccid. There will be a loss of body weight and body condition, reduction in face and vent color, and eventually molting will occur. The last stage (molting) cannot be recovered from. On observing any combination of these symptoms, immediately check clean-up time, feeding space per bird, and separate-sex feeding systems. Next, the accuracy of weekly average weight gain data should be verified and a sample of males (10% of the population) re-weighed. If inadequate body weight is verified, increase feed allowance by 3-5 g/bird/day (0.7-1.1 lb/100 birds/day) without delay. Prompt action is essential.

### Overfeeding

Excessive feed consumption in males may occur due to oversupply (inaccurate weighing of feed), variation among males in intake, or feeding from female feeders (inadequate measures to ensure male exclusion). If body weight control is poor, a sub-population of heavy males with excessive breast development may occur. Females will begin to avoid mating if a considerable percentage of males are overweight. Additionally, over-fleshed males may become impaired in their ability to successfully complete matings. Overweight males losing condition will be among the first to undergo testicular regression and associated reductions in mating activity and fertility will occur. Excessively overweight males (10% or more over target weight) should be carefully assessed and removed from the flock if they are not mating (see section on *Assessment of Bird Physical Condition*).



- Monitor male physical condition (fleshing and muscle tone) and body weight weekly.
- Grow males to the target body weight and physical condition and achieve target weekly body-weight gains.
- Use separate-sex feeding with adequate well-maintained equipment.
- Observe feeding behavior daily.
- Any shortfall or reduction in male body weight has serious implications for fertility.
- Consider removing overweight males (10% or more over target weight) from the flock.

## Mating Ratio

To maintain fertility throughout lay, each flock will require an optimum number of sexually active males. As the flock ages and egg production declines, fewer males are required to maintain fertility (**Table 16**), so substandard and non-working males can be progressively removed from the flock as it ages. The mating ratios given below are a guide only and should be adjusted according to local circumstances and flock condition. Higher ratios than those given in the table may be required in open-sided laying houses where mating activity may be lower due to high environmental temperatures.

**Table 16:** A guide to typical mating ratios as a flock ages.

Age		Number of Good Quality Males Per 100 Females
Days	Weeks	
154 - 168	22 - 24	9.50 - 10.00
168 - 210	24 - 30	9.00 - 10.00
210 - 245	30 - 35	8.50 - 9.75
245 - 280	35 - 40	8.00 - 9.50
280 - 350	40 - 50	7.50 - 9.25
350 to depletion	50 to depletion	7.00 - 9.00

Mating ratio should be reviewed weekly. Based on an assessment of physical condition and body weight, any males considered to be non-working should be removed from the flock in line with recommendations to achieve suggested mating ratios. Males retained for mating should have the following characteristics (see section on *Assessment of Bird Physical Condition* for more information):

- Uniformity in body weight.
- Freedom from physical abnormalities (alert and active).
- Strong, straight legs and toes.
- Well feathered.
- Good upright stance.
- Good muscle tone and body condition.
- Comb, wattles and vent showing evidence of mating activity.

The removal of non-working males from the flock should be a continuous process. Removing a large number of males at one time will lead to unnecessary disturbance.

## Over-mating

A surplus of males leads to over-mating, interrupted mating, and abnormal behavior. Over-mated flocks will exhibit reductions in fertility, hatchability, and egg numbers. In the early stages, after mating-up, it is quite normal to observe some displacement and wear of the feathers at the back of the female's head and of the feathers on the back at the base of the tail. When this condition progresses to the removal of feathers, this is a sign of over-mating. If the mating ratio is not reduced, the condition will worsen with de-feathering of areas of the back and skin scratches occurring. This may lead to low welfare, loss of female condition, and reduced egg production. Excessive injuries and feather damage to the males as a result of fighting may also occur. Over-mated females may be seen hiding from the males beneath equipment or in nest boxes, or refusing to come down from the slatted area.

Surplus males must be removed quickly or a considerable loss in persistency of male fertility will result. The signs of over-mating generally become more obvious at around 182 to 189 days (26 to 27 weeks), becoming most apparent by 210 days (30 weeks), but the flock should be examined for signs of over-mating on a daily basis from 175 days (25 weeks) onwards. When over-mating occurs, the removal of males from the flock should be advanced with an additional one-off removal of males from the flock. An additional 1 male per 200 females should be removed and then the planned pattern of reduction (1 male per 200 females every 5 weeks - see **Table 16**) should continue to be followed.



- As the flock ages, fewer males may be required to maintain flock fertility. Having males of good quality is key.
- Substandard and non-working males should be continuously removed as the flock ages.
- Review mating ratios weekly.
- Monitor females for signs of over-mating from 25 weeks of age.
- Whenever over-mating occurs, surplus males must be removed as quickly as possible; inspect males and remove those that are not working.



## Section 3 - Management in Lay (Peak to Depletion)

# Management of Females After Peak Production Through to Depletion

### Objective

To maximize the number of fertile hatching eggs produced per female, by ensuring persistency of egg production post-peak.

### Principles

To maintain productive performance beyond peak production, females must gain body weight close to the recommended target. Failure to control body weight (and thus fat deposition) post-peak can significantly reduce persistency of lay, shell quality and female fertility and it can increase egg size after 40 weeks of age.



#### Other Useful Information Available

Ross Note: *Female Persistency Post-Peak - Managing Fertility and Production*

Ross Note: *Controlling Late Egg Size in Broiler Breeders*

### Factors for Post-peak Management

Post-peak females must gain body weight close to the recommended target. If body-weight gain is inadequate, total egg production will be reduced. If body-weight gain is too rapid, post-peak production persistency and fertility will be lowered.

Shortly after peak production, maximum nutrient requirements for egg production occur because egg mass continues to increase after there has been some reduction in rate of lay. Peak egg production is usually achieved around 217 days (31 weeks) and can be defined as no increase in daily hen-day production over a 5 day period. Shortly after peak production, at around 224 to 231 days (32 to 33 weeks), peak egg mass occurs.

**Egg Mass = (Average Egg Weight [g/oz] x Hen-Week %) ÷ 100**

From the time of peak production, growth should continue but at a slower weekly rate (see the **Ross Parent Stock Performance Objectives** for more information).

Birds should never lose weight. However, after peak feed has been given and peak egg production has occurred, relative feed reductions will be required in order to achieve the recommended target body weight and to limit rate of fat deposition as egg production declines. Post-peak feed reductions should start when egg mass does not increase over a period of 5-7 days. Good persistency will be maintained by controlling body weight gain to 20 g/female/week (0.7 oz/female/week) to manage egg weight gains and therefore egg mass.



## Procedures

Many factors are involved in determining the exact timing of the initial feed reduction post-peak. Timing and amount of feed reduction may be affected by:

- Body weight and body-weight change from the start of production.
- Daily egg production and the hen-day production trend.
- Daily egg weight and egg weight trend.
- Egg mass trend.
- Health status of the flock and feathering condition.
- Ambient environmental temperature.
- Feed energy and protein levels.
- Feed texture.
- Feed quantity consumed at peak (energy intake).
- Flock history (rearing and pre-peak performance).
- Changes in feed clean-up time.
- Feather cover.

Due to variation between flocks in the characteristics given above, the program of feed reduction will vary for each flock. To enable the farm manager to monitor and establish an appropriate feed reduction program, it is critical that the following characteristics are measured, recorded and graphed onto a chart:

- Daily (or weekly) body weight and body-weight change relative to the target (see the **Ross Parent Stock Performance Objectives** for more details on target body weights). Accurate body weight monitoring is critical during the post-peak period (see section on *Monitoring Broiler Breeder Growth*).
- Daily egg weight and egg weight change relative to the target.
- Daily changes in feed clean-up time. Clean-up time is the time between feeder switch-on and trough clearance; at peak these are normally 3-4 hours for mash, 2-3 hours for crumbles, 1-2 hours for pellets. If clean-up time is more or less than the times indicated, it suggests that feed levels may be too high or too low respectively.

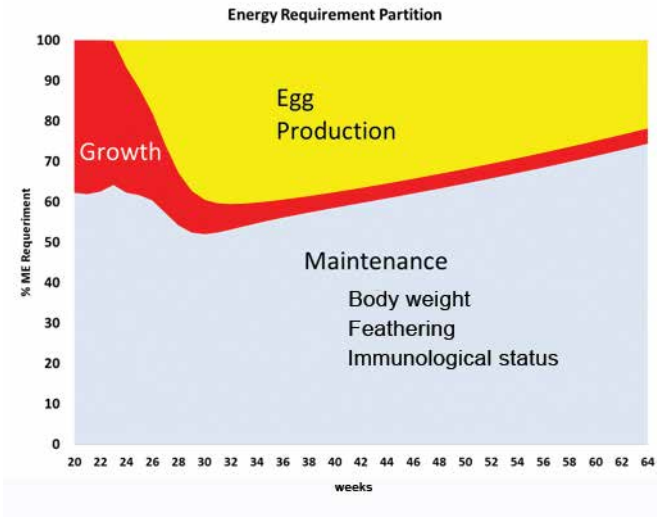
In addition, the farm manager should routinely handle and examine the birds to ensure they are in good physical condition (see section on *Assessment of Bird Physical Condition* for more information).

## General Guidelines for Post-peak Feed Reductions Based on Target Performance Characteristics

Under moderate temperate conditions where performance levels are close to or on target and birds are fed the recommended nutrient levels, general guidelines for feed reductions after peak can be found in the **Ross Parent Stock Performance Objectives**. Birds must receive the correct amount of feed to adequately fulfil their changing requirements for growth, egg production and maintenance (**Figure 57**). However, the actual program of feed reduction should be based on the close and accurate monitoring of daily body weight, daily egg weight and feed clean-up time. Normally, good production is achieved when total feed allocation reduction is between 5-8% from peak feed to depletion. Aviagen studies have shown that feed reductions >8% may negatively affect performance.

Feed reductions are normally initiated around 5 to 6 weeks after peak production has occurred. However, if body weight increases are above target between peak and 35 weeks of age (if there is a change in the direction of the growth curve), feed withdrawal may need to begin earlier than this.

**Figure 57:** Components of the total energy requirements of broiler breeder females from 20-64 weeks of age.

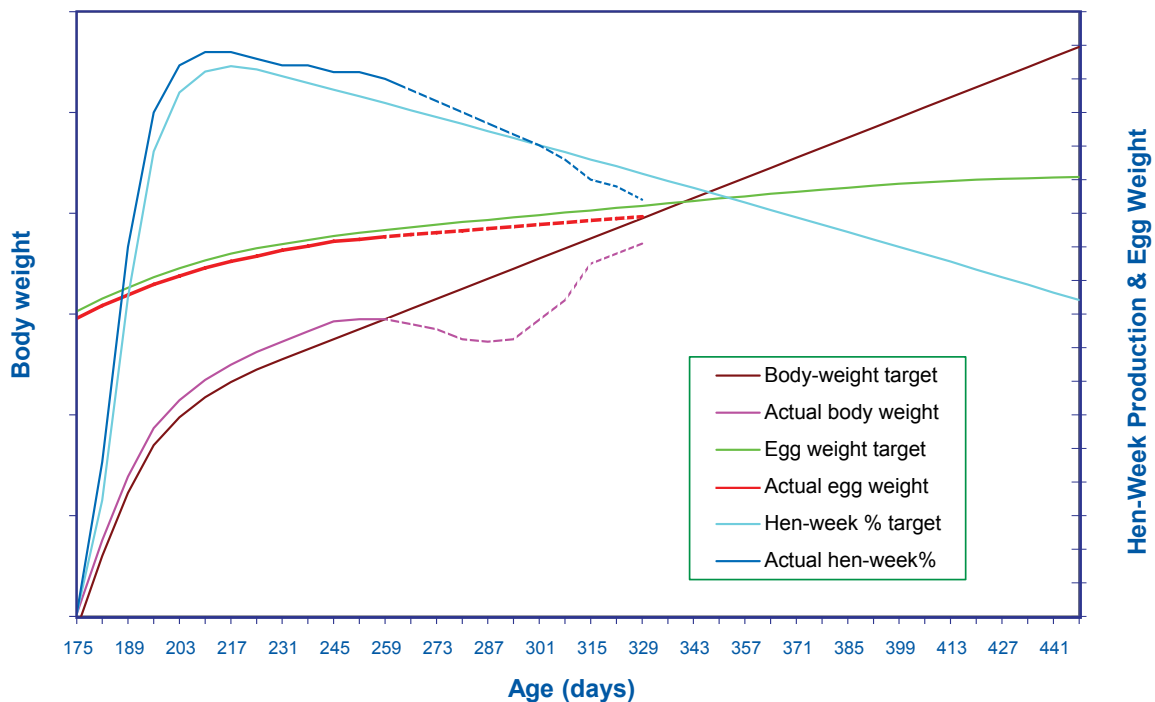


There will be situations where flock performance differs markedly from the published performance targets and the feed reduction program will need to be altered accordingly to account for this. The following are examples of two specific field situations illustrating suggested feed reduction strategies where performance differs from published targets.

**Flocks Performing Above Target Recommendations**

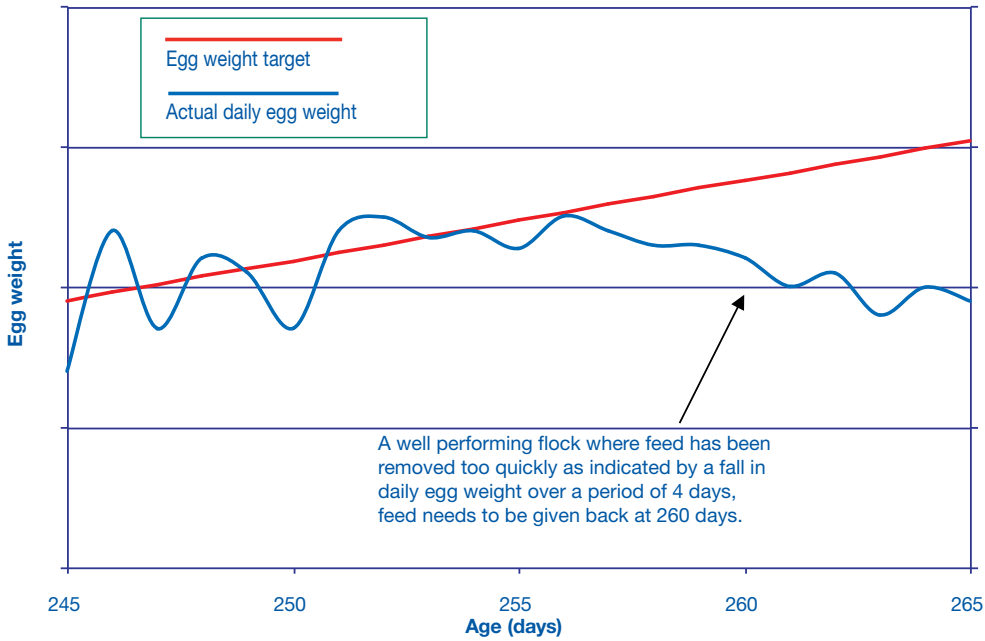
Flocks performing above the published performance targets can be under-supplied in feed and thus nutrients, and both body weight and egg weights may start to slow or fall off when compared to the expected incremental gain (see example in **Figure 58**). Excessive feed reductions after peak can potentially have a negative impact on production and leave birds susceptible to molting and broodiness. When flocks are performing above target recommendations, feed reductions after peak should be less and more gradual; peak feed may need to be held for longer, onset of feed reduction delayed and less feed reduced overall from 245 days (35 weeks) to depletion.

**Figure 58:** A graph illustrating the effects of underfeeding a flock performing above the hen week production target. The dotted lines indicate what would happen to performance if appropriate adjustments to feed reductions are not made.

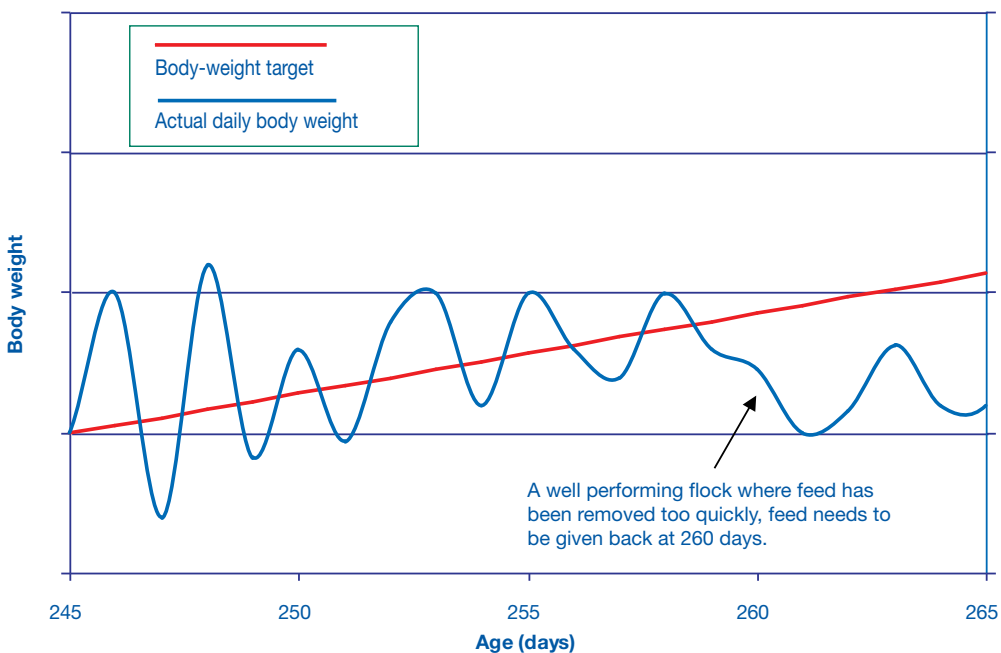


Daily egg weight, body weight, production and feed clean-up times should be monitored closely. In particular, recording and monitoring body weight and egg weight will indicate if feed reduction is being done correctly. Under normal conditions, a gradual reduction in egg weight and then body weight are the first signs that feeding is not correct, and will precede a drop in production. In **Figure 58**, the graph illustrates a flock performing above target where the information has been collated and graphed daily. While general trends in performance can be monitored in this way, weekly recording does not allow sufficient early detection of potential performance issues in egg and body weight. Small but important changes will occur within days if nutrition is inadequate and it is recommended that daily egg weights and body weights are measured, recorded, and monitored separately so that any gradual reduction in weight can be rapidly detected and acted upon (**Figure 59** and **Figure 60**).

**Figure 59:** An example of a flock performing above hen-week target, where egg weight is falling away from the expected target in a consistent and continuous way over a period of at least 4 days.



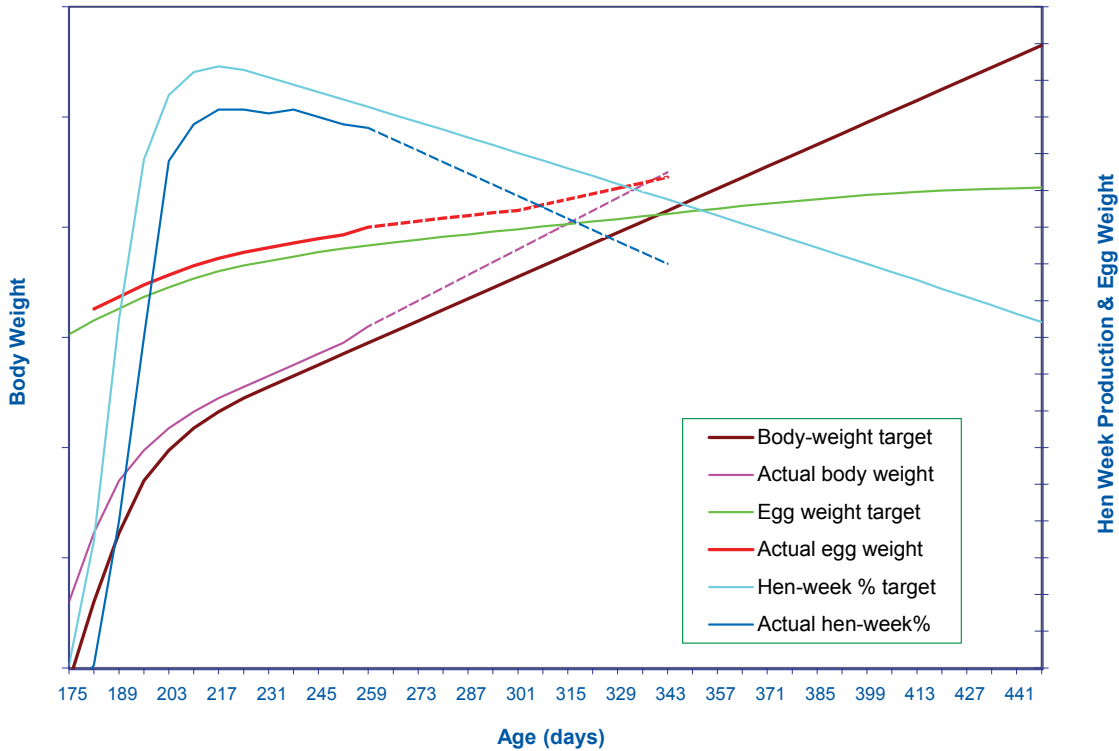
**Figure 60:** An example of a flock performing above hen-week target, where body weight is falling away from the expected target in a continuous and consistent way.



**Flocks Performing Below Target Recommendations**

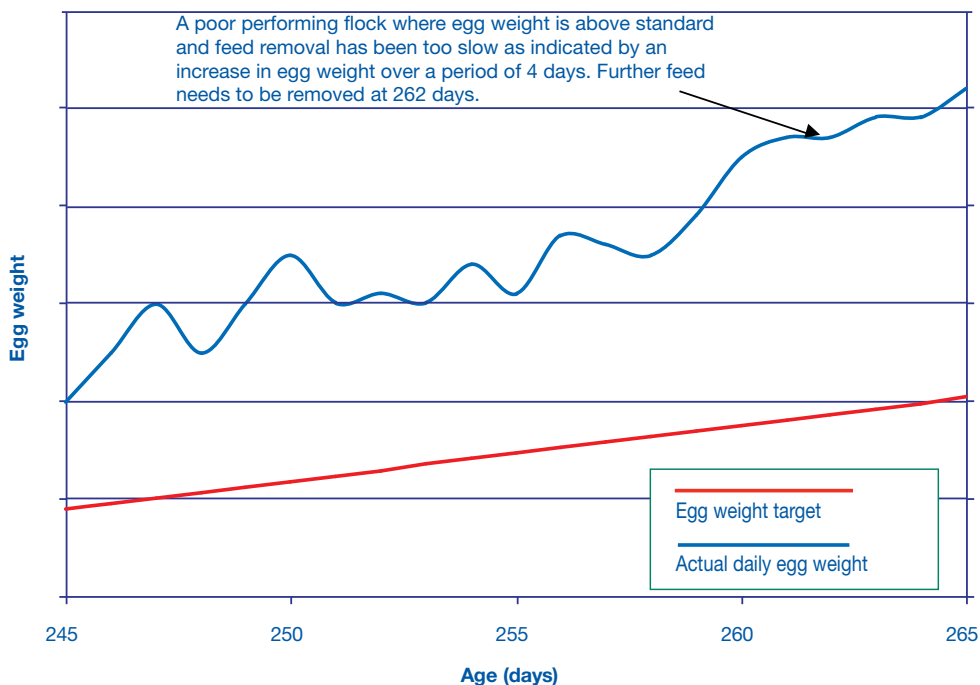
For flocks that perform below the published performance targets, feed reduction can be greater. Excess feed levels will result in such flocks becoming overweight with poor persistency and increased egg weight (see **Figure 61**). Daily egg weight, body weight, production and feed clean-up times should be monitored closely to determine if feed reduction is being done correctly. In flocks that are performing below target, the overall feed reduction from peak to depletion will be more when compared to higher-performing flocks. Initial feed reductions after peak can be in the range of 8-11 kcal ME per week.

**Figure 61:** A graph illustrating a flock performing below the hen-week production target. The dotted lines indicate what would happen to performance if appropriate adjustments to feed reductions are not made.

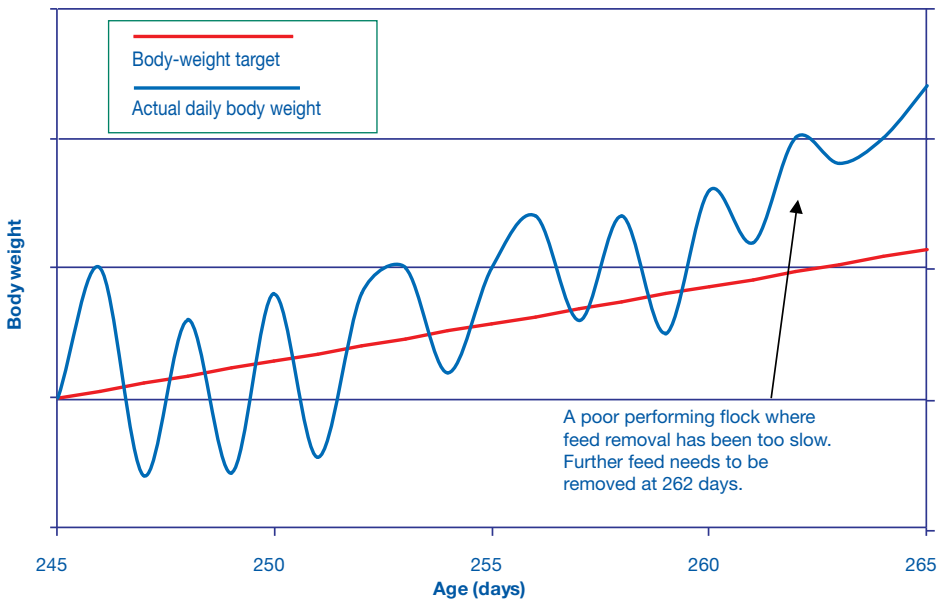


The early detection of potential performance issues requires that daily egg weights and body weights are measured, recorded and monitored separately. **Figure 62** and **Figure 63** illustrate how closer daily examination of the data indicates where there was a higher than expected increase in egg weight and then body weight as feed reductions after peak have been too slow.

**Figure 62:** An example of a flock performing below hen week target where the increase in daily egg weight becomes continuously and consistently higher than expected over a period of at least 4 days.



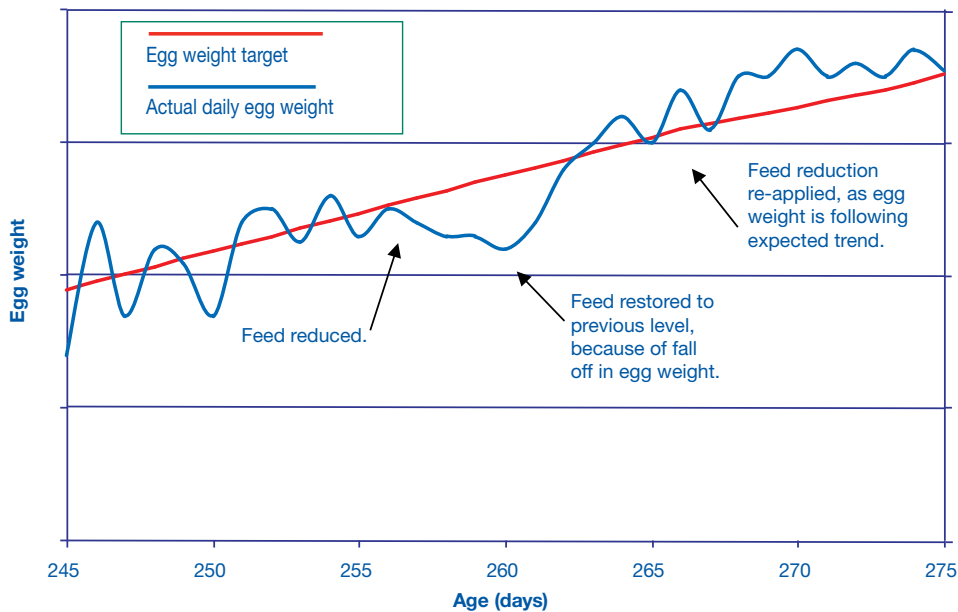
**Figure 63:** An example of a flock performing below hen-week target where the increase in daily body weight becomes continuously and consistently higher than expected.



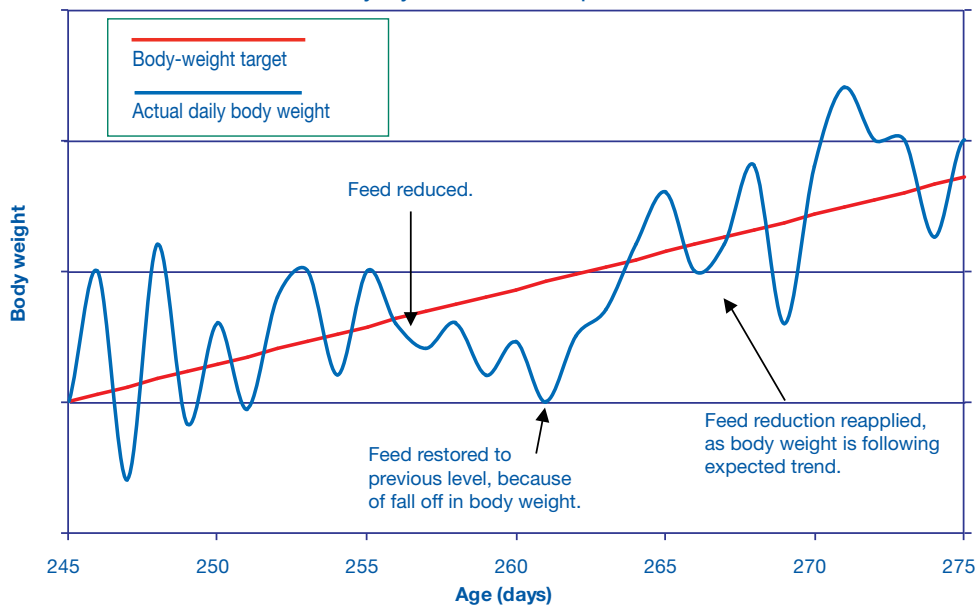
### Monitoring Post-Peak Feed Reduction

In any flock (high, average, or low producing) after any post-peak feed reduction, the response to that feed reduction should be monitored carefully. If production, egg weight or body weight decreases more than expected, restore the feeding amount to the previous level and attempt to reduce the feed level again 5-7 days later (**Figure 64** and **Figure 65**).

**Figure 64:** An example of re-assessment of feed removal when the daily egg weight decreases in a consistent and continuous way by more than expected and feed levels need to be increased again.

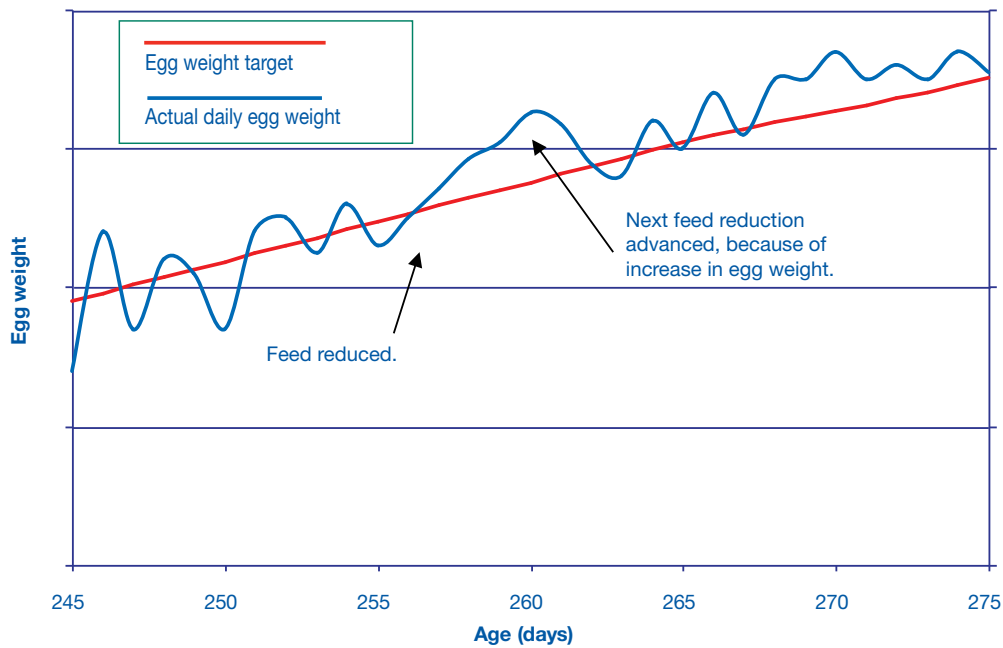


**Figure 65:** An example of re-assessment of feed removal when the daily body weight decreases in a consistent and continuous way by more than expected and feed levels need to be increased again.



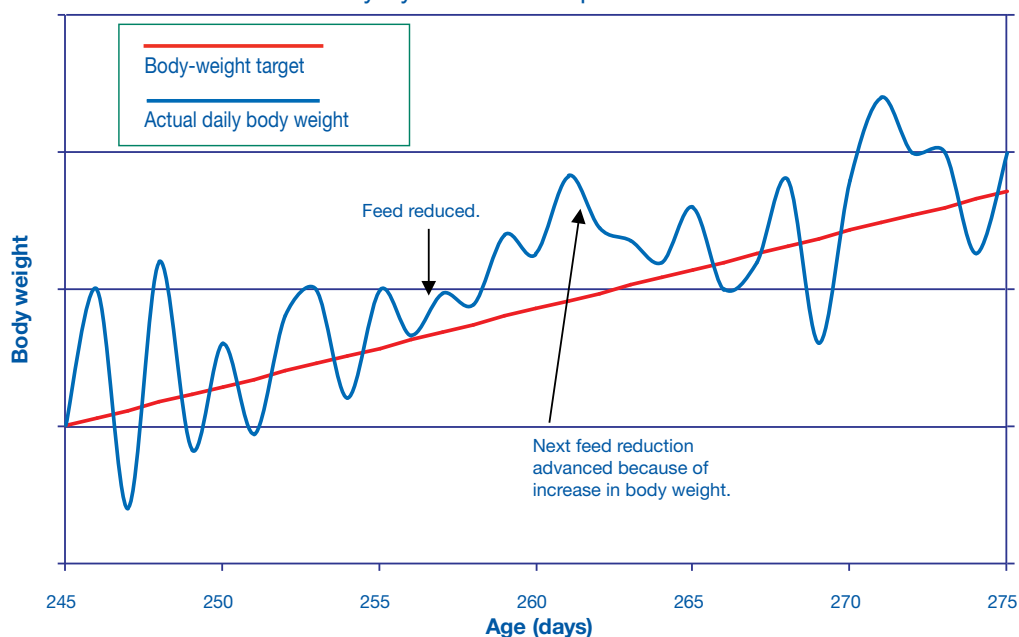
If egg weight or body weight increases more than expected and a fall off in persistency occurs, the next feed reduction should be advanced (**Figure 66** and **Figure 67**).

**Figure 66:** An example of re-assessment of feed removal when the daily egg weight increases in a consistent and continuous way by more than expected and feed levels need to be reduced again.





**Figure 67:** An example of re-assessment of feed removal when the daily body weight increases in a consistent and continuous way by more than expected and feed levels need to be reduced again.



## Post-Peak Feed Reductions and Environmental Temperature

If flocks peak during hot weather, feed should be reduced sooner and more quickly compared to more temperate conditions. However, as ambient temperatures change, feed levels should be reviewed and adjusted accordingly to ensure that birds' energy requirements are achieved. Monitor feed clean-up time so that any variations are managed.

Hens with poor feather cover will have a higher energy need, especially in cold environments. If calorie consumption is not correctly adjusted for cold temperatures and poor feather cover, it will likely result in a drop in production, hatchability and fertility, particularly during the last weeks of production.



- Monitoring and control of body weight and egg weight are major priorities post peak.
- Follow a post-peak feed reduction program that allows the birds to gain weight at a rate of 20 g/week (0.7 oz). This will help attain egg production, body weight and egg weight profiles.
- Failure to control body weight from peak production will reduce production persistency and effect egg size.
- Monitor and record daily body weight and egg weight and make weekly feeding decisions based on these daily trends in relation to target. If trends indicate, then make changes in feed allowances earlier.
- Flocks producing at levels above egg production targets may require more feed and feed reductions should be of smaller amounts and more gradual.
- If a flock peaks poorly, the feed withdrawal should be more rapid to avoid birds becoming fat.
- As temperature changes, review and adjust feed levels to ensure correct energy requirements are achieved.
- Poorly feathered hens will have a higher energy need to ensure drops in production do not occur.

# Management of Males After Peak Production Through to Depletion

## Objective

To maintain persistency of fertility.

## Principles

Maintaining male condition and feeding and appropriately managing male numbers in lay are key for maintaining male fertility post-peak.

## Procedures

Management principles and procedures for males in the post-peak period are similar to those used in the pre-peak period. Adjusting feed quantity to achieve a gradual but constant increase in weight as the male ages is the most effective means of controlling body weight and body condition. Thus persistency of fertility can be maintained. Mating ratios must also be optimized and managed.

A sample of males taken from throughout the male pen should be weighed frequently (at least once a week) to ensure this is achieved. At the same time as each male is weighed, they should be evaluated to determine if they are maintaining ideal body condition, fleshing, and vent coloration. Maintaining these characteristics supports mating activity throughout the flock's life. It is important that an adequate sample size is weighed and assessed. A sample size that is too small (less than 10% of the population) can mislead the farm manager (for more information, refer to the section on *Monitoring Broiler Breeder Growth*).

Male feed allocations should continue to increase throughout the life of the flock. They should never be decreased. From around 30 weeks of age, males should be given feed increases that result in the desired average weekly body-weight gains. Actual changes in male feed quantities and frequency of feed increases should be made based on the sample evaluated, using body weight data and other husbandry information such as body condition and fleshing and uniformity.

A planned mating ratio reduction program should be followed to maintain persistency of fertility (see section on *Management into Lay*). The optimum mating ratio should be maintained by removing males according to their physical condition (see section on *Assessment of Bird Physical Condition*).

Flocks with footpad problems have reduced mating and lower fertility. Litter condition and slat construction have a major effect on male footpad health and ultimately on the ability to mate. If litter becomes wet, compacted, or of inadequate volume, additional litter must be added to give males (and females) a comfortable area to walk on and mate.



- Never decrease male feed allocation.
- Ensure sufficient sample size is weighed.
- Make sure feed increases account for body weight, fleshing and physical condition to maintain growth and persistency of fertility.
- Maintain adequate quantities of dry litter to promote good footpad health.
- Follow a planned male reduction program.



## Section 4 - Monitoring Broiler Breeder Growth

### Monitoring Broiler Breeder Growth

#### Objective

To manage bird development by obtaining an accurate estimate of the average body weight and CV%/uniformity for each population of birds.

#### Principles

Weigh birds at least weekly using a standardized, accurate and repeatable procedure. Target body weight-for-age and flock uniformity can then be controlled by management of feed allowance and feed distribution so that reproductive performance is maximized.



#### Other Useful Information Available

Broiler Breeder Management How To: *Bulk Weigh Broiler Breeders*

Broiler Breeder Management How To: *Individually Weigh Broiler Breeders*

#### Body-weight Weighing Methods

Flock growth and development are assessed by weighing representative samples of birds and comparing sample weights with target body weight-for-age.

All measurement systems require calibration and standard weights should be used to check that scales are weighing accurately. A calibration check should be made at the beginning and end of every sample weighing.

Two main weighing systems are available - manual and electronic. Either type of weighing scale can be used successfully, but the same scale should be used each time for reliable repeat measurements of an individual flock.

No matter which weighing system is used, the people handling birds should work in a calm manner, and be appropriately trained considering bird welfare at all times.

#### Manual weighing scales

Several types of manual scales are available (an example is given in **Figure 68**). These can be used to weigh birds to an accuracy of  $\pm 20$  g (0.04 lbs) and have a capacity up to 5 kg (11 lbs). Conventional (mechanical or dial) scales require manual data records to be kept and data calculations to be made manually.

**Figure 68:** Manual suspended balance for weighing birds.



**Electronic weighing**

Electronic scales (**Figure 69**) are available that record individual bird weights to the nearest gram (oz), and can calculate and print-out the population statistics (**Figure 70**) automatically:

- Total number of birds weighed.
- Average weight of birds.
- Deviation or range.
- CV%.

**Figure 69:** Examples of electronic weighing scales for individual chick weights up to 7 days (left), electronic scales for individual bird weights after 7 days (center) and platform scales (right) where birds weigh themselves individually.



**Figure 70:** Examples of a print-out from an automatic weigh scale (metric and imperial).

CURRENT DATA METRIC		CURRENT DATA IMPERIAL	
TOTAL WEIGHED:	79	TOTAL WEIGHED:	79
AVERAGE WEIGHT:	0.471	AVERAGE WEIGHT:	1.037
DEVIATION:	0.048	DEVIATION:	0.105
C.V. (%):	10.2	C.V. (%):	10.2

Band limits	Total	Band limits	Total
0.320 to 0.339	1	0.705 to 0.747	1
0.340 to 0.359	1	0.750 to 0.791	1
0.360 to 0.379	2	0.794 to 0.836	2
0.380 to 0.399	2	0.838 to 0.880	2
0.400 to 0.419	4	0.882 to 0.924	4
0.420 to 0.439	7	0.926 to 0.968	7
0.440 to 0.459	12	0.970 to 1.012	12
0.460 to 0.479	15	1.014 to 1.056	15
0.480 to 0.499	14	1.058 to 1.100	14
0.500 to 0.519	10	1.102 to 1.144	10
0.520 to 0.539	6	1.146 to 1.188	6
0.540 to 0.559	3	1.190 to 1.232	3
0.580 to 0.599	2	1.279 to 1.321	2

### Methodology for Sample Weighing

Birds should be weighed weekly from placement (day 0). At 0, 7 and 14 days of age, samples can be weighed in bulk (**Figure 71**). After 14 days of age, take individual bird weights.

At placement (day 0), at least three boxes of chicks should be bulk weighed per pen. The number of live chicks in each box and the weight of the chick box must be known in order to accurately calculate average chick weight. In addition, it is recommended to individually weigh the chicks in 1 box per pen at placement to assess chick quality and help determine initial early chick management procedures.

From 7 days onward, a **minimum** sample of 2% or 50 birds, whichever is greater, should be weighed per population. At 7 and 14 days of age, bulk weigh 10-20 birds at a time until the entire sample (a minimum of 2% or 50 birds) has been weighed.

Bulk weighing allows the determination of average bird weight and average weekly body-weight gain. Comparison of average bird weight to target weight facilitates feeding decisions. However, for the determination of CV%, birds need to be weighed individually.

**Figure 71:** Example of bulk weighing chicks up to 14 days of age.

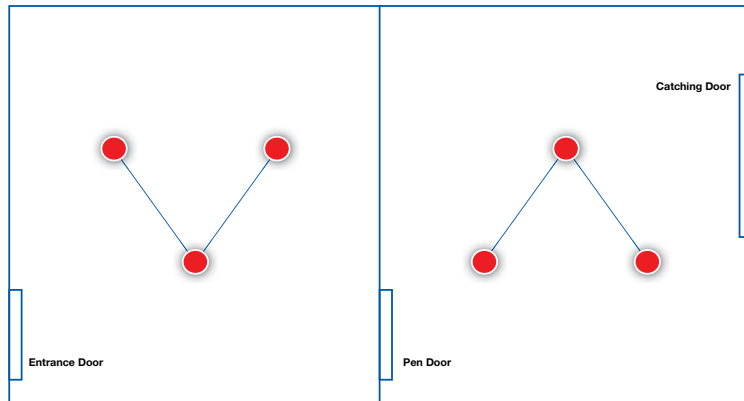




Recording of individual bird body weights should occur as early as is practically possible, generally between 14 and 21 days (2 and 3 weeks) of age. A **minimum** sample of 2% or 50 birds (whichever is the greater) per population should be caught using catching frames and then individually weighed. **All** birds captured in the sample must be weighed in order to eliminate any selective bias. In rear, if the individual population exceeds 1,000 birds, 2 sample weighings should be taken from different locations in the pen or house. In lay, samples should be taken from a minimum of 3 different locations within the population. In this way, samples will be as representative as possible and estimates of body weight will have increased accuracy.

Birds for sample weighing should be caught towards the middle of the pen away from any doors or the sides of the pen (**Figure 72**). Weighing needs to be completed on the same day each week and at the same hour of the day (4-6 hours after feeding).

**Figure 72:** Example of the correct sampling points within a house during the laying period.



● Bird sample points

**Procedures for Manual Scales**

When manual scales are used, individual bird weights should be recorded on a weight-recording chart (Figure 73) as the birds are weighed.

**Figure 73:** Example of manual body-weight recording chart.

**Body-Weight Recording Chart**



FARM	BREED	HOUSE	PEN	SEX	AGE	DATE
		2		Female	28	Mar-15
NUMBER WEIGHED	AVERAGE WEIGHT	TARGET WEIGHT	% Coefficient of variation			
212	464 g (1.02 lbs)	450 g (0.99 lbs)	10.3			

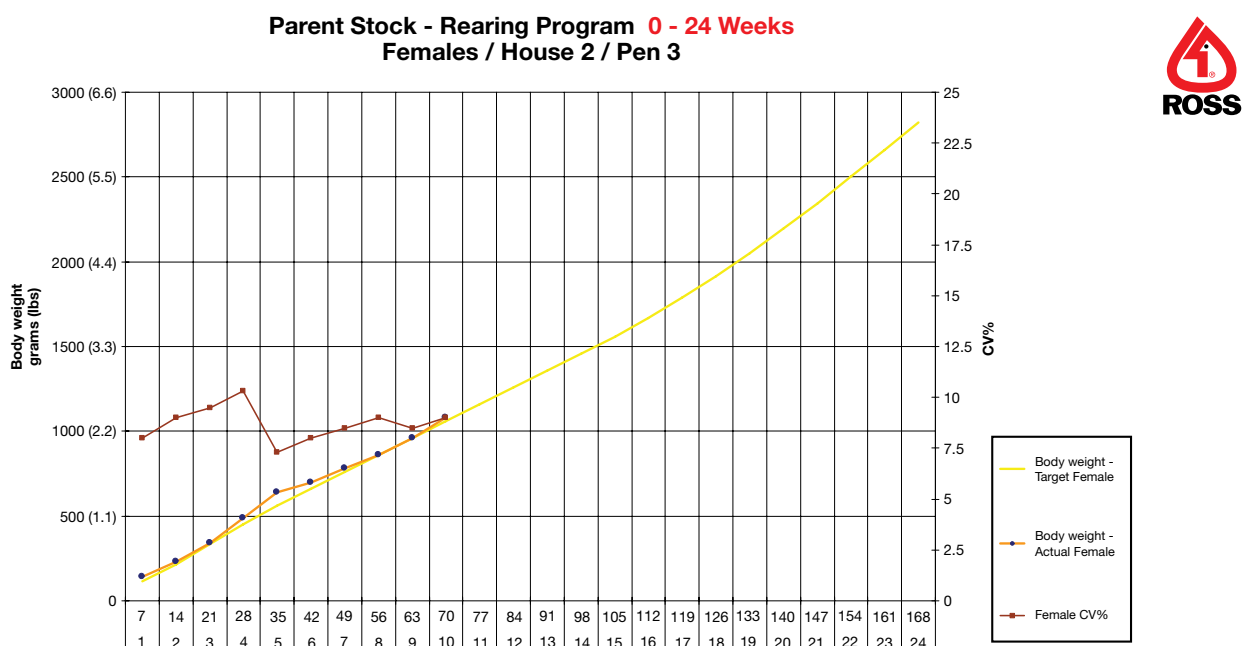
WEIGHT POUNDS	WEIGHT GRAMS	NUMBER OF BIRDS																													
		1	2	3	4	5	6	7	8	9	10	11	12	13	14	15	16	17	18	19	20	21	22	23	24	25	26	27	28	29	30
0.00	0.00																														
0.04	0.20																														
0.09	0.40																														
0.13	0.60																														
0.18	0.80																														
0.22	100																														
0.26	120																														
0.31	140																														
0.35	160																														
0.40	180																														
0.44	200																														
0.49	220																														
0.53	240																														
0.57	260																														
0.62	280																														
0.66	300																														
0.71	320																														
0.75	340	x	x	x	x	x																									
0.79	360	x	x	x	x	x	x	x	x	x	x	x																			
0.84	380	x	x	x	x	x	x	x	x	x	x	x	x	x																	
0.88	400	x	x	x	x	x	x	x	x	x	x	x	x																		
0.93	420	x	x	x	x	x	x	x	x	x	x	x	x	x	x	x	x	x													
0.97	440	x	x	x	x	x	x	x	x	x	x	x	x	x	x	x	x	x	x	x	x	x	x	x	x	x	x	x	x	x	
1.01	460	x	x	x	x	x	x	x	x	x	x	x	x	x	x	x	x	x	x	x	x	x	x	x	x	x	x	x	x	x	
1.06	480	x	x	x	x	x	x	x	x	x	x	x	x	x	x	x	x	x	x	x	x	x	x	x	x	x	x	x	x	x	
1.10	500	x	x	x	x	x	x	x	x	x	x	x	x	x	x	x	x	x	x	x	x	x	x	x	x	x	x	x	x	x	
1.15	520	x	x	x	x	x	x	x	x	x	x	x	x	x	x	x	x	x	x	x	x	x	x	x	x	x	x	x	x	x	
1.19	540	x	x	x	x	x	x	x	x	x	x	x	x	x																	
1.23	560	x	x	x	x	x	x	x	x	x	x	x	x																		
1.28	580	x	x	x	x	x	x	x																							
1.32	600																														
1.37	620																														
1.41	640																														
1.46	660																														
1.50	680																														
1.54	700																														
1.59	720																														
1.63	740																														
1.68	760																														
1.72	780																														
1.76	800																														
1.81	820																														
1.85	840																														
1.90	860																														
1.94	880																														

After weighing, the following parameters can be calculated for the flock:

- Average weight
- Weight range (highest body weight - lowest body weight)
- Coefficient of variation (CV %)

Average body weight and CV% should be plotted on a body-weight-for-age graph and compared to the target. An example of such a chart is given in **Figure 74**. Variation from performance targets will help to determine future feed allocations.

**Figure 74:** Example of a chart for weekly recorded pen body weight and CV% compared with performance standards. In this example, body weight is on target and CV% is good; feed increases should follow recommendations.



**Procedures for Electronic Scales**

If electronic scales are used, the population statistics (average weight, average body-weight gain, weight range, and CV%) are automatically calculated and given on the print-out (**Figure 70**). As with manual scales, the average body weight and CV% figures should be plotted on a body weight for age graph and compared to targets. Establishing variation from target will help determine future feed allocations.

**Notes on Sample Weighing of Males**

It is important to maintain male body weight and physical condition after mating-up, but accurate monitoring of body weight can be more difficult at this time. False variation in bird weight over time may arise because of the difficulty in catching representative samples of males. So it is crucial that a good male sample size (male sample size should be increased to a minimum of 10% of the population from mating-up), from different locations in the house, is weighed during lay.

Where an automatic (jump-on platform) weighing scale is set up in a house, male body weights must still be measured by hand weighing using either manual or electronic scales. This is to verify the accuracy of the automatic system. Male sample sizes for automatic weighing systems can tend to be unrepresentative, because as males increase in size, they become less likely to use these platforms. Hand weighing (which should be completed weekly from point of lay as a matter of course) also provides an opportunity to check the physical condition of the males.

### Note on Sample Weighing of Females

Where automatic (jump-on platform) weigh scales are used and the female weights from these indicate an unexpected variation or deviation from the expected target, a sample of birds should be re-weighed by hand weighing. If the variation is confirmed, the platform scales should be recalibrated to check they are working correctly. Additional hand weighing of females is not required routinely, as with males.

### Inconsistent Weight Data

If a sample weighing produces data that is inconsistent with the previous weights or expected gains, a second sample of birds should be weighed immediately as a check before any decisions on feed allowances are made. This will identify potential problems (e.g. improper sampling procedure, feed allowance errors, drinker failures, or disease) that may need to be rectified.



- Assess and manage growth and development in a flock by weighing representative samples of birds and comparing them with target weight for age.
- Start sample weighing at day-old and continue at least weekly.
- Take individual bird weights from 14-21 days of age for calculation of CV%.
- Weigh a **minimum** of 50 birds or 2% of the female population (10% of the male population), however all birds caught in the sample must be weighed.
- Weigh birds at the same time each week using the same set of scales.
- Check scale accuracy regularly.
- Record and plot average body weight and CV% on a body-weight-for-age chart.
- If sample weighing produces data inconsistent with previous weights or expected gains, weigh a second sample immediately.



## Section 5 - Assessment of Bird Physical Condition

# Assessment of Bird Physical Condition

### Objective

To ensure persistency of fertility and egg production by achieving optimum physical condition of males and females.

### Principles

Regular physical assessment of birds provides additional information for guidance on required adjustments in management practices to ensure persistency of reproductive performance.

The physical assessment of birds within a flock involves monitoring a number of factors, including body weight, body condition (breast shape and degree of fleshing), and skeletal frame size to get a good overall view of bird condition, muscle tone, health and reproductive potential.

### Assessing Bird Condition

Assessments of bird condition (e.g. fleshing, legs and feet) should be completed, at least weekly, from placement through to depletion. This assessment should be done as part of the routine flock management procedures and will help to develop good stockmanship techniques in farm personnel. From these regular assessments, an awareness of what birds should both look and feel like at any given age can be developed. This knowledge will support management decisions and help recognize and solve problems. There are two opportunities to assess the flock - when birds are being weighed or when doing a house walk-through.

It is important that the flock is maintained in optimal condition throughout its life. However, it should be recognized that the optimum will vary slightly at different times during the production cycle, depending on, for example, whether or not the flock is approaching sexual maturity, is at peak production, or is established in lay. At any point in time, an inadequate (under-fleshed or thin) or excessive (over-fleshed or fat) condition will have a negative impact on flock performance and should be avoided. Particular attention to bird condition should be paid:

- In the period leading up to the start of egg production (19-24 weeks of age) for females.
- Throughout lay for males when a male reduction plan is being followed.

Weighing provides the ideal opportunity to assess bird physical condition. As a general rule, a minimum of 50 birds or 2% of the population (whichever is the greater) should be sampled for females and a minimum of 10% of the population should be sampled for males (for more information see the section on *Monitoring Broiler Breeder Growth*). Physical condition should be routinely assessed and recorded on all birds sampled for weighing.

In addition, it is good management practice to walk through the flock at least once a week, picking up a selection of individual birds to assess their physical condition. As a guide, a minimum of 20-30 females and 15 males should be selected at random, and their physical condition assessed.





- Regular assessments of physical condition should be made throughout the life of the flock.
- Using a combination of physical assessments will provide a better indication of bird condition and fitness-for-purpose and thus facilitate better management decisions (feeding allocation and implementation of male number reduction plans).
- A representative sample of the population should be assessed at least weekly during weighing to determine overall flock condition, but individual birds should also be assessed. It is good practice to catch and physically assess individual birds while doing a house walk-through.

## Assessment of Male Condition

Males that are in good physical condition will have good fertility. Completing routine physical assessments of male condition throughout the life of the flock will help ensure that optimum fertility is achieved.

Any personnel handling birds should do so with due care and attention and must be appropriately trained.

### Rear

During rear, it is important that birds achieve target body weight and that the flock is uniform in its development. Skeletal frame size and shank length can be a useful means of visually comparing male development and are supportive management tools. Up to 63 days (9 weeks) of age there is a positive relationship between body weight, frame size, and shank length (**Figure 75**). In general, birds that achieve the recommended body-weight target during rear will also achieve good uniform development of the shank and frame (skeleton). Observing birds at the feed track and/or at nipple or bell drinkers, and looking at the variation in shank length provides an opportunity to see if there is a high level of variability within a population (suggesting poor uniformity). The reasons for this variability should be investigated (e.g. poor feed distribution, inadequate feeder space, health issues, poor brooding conditions).

**Figure 75:** Shank length in males. The male on the left has poorer development of the shank in both length and diameter.



Birds that follow the recommended body-weight profile in rear should also achieve a body condition that is acceptable. However, regular and routine monitoring of male fleshing in conjunction with measurement of body weight can provide a more accurate indicator of overall body condition and establish more appropriate management and feeding strategies. To achieve this, males should be handled regularly and physical body condition assessed at least weekly during weighing from placement, paying particular attention between 15 weeks of age and the start of production in preparation for sexual maturity. It is also important to be aware of general health, alertness and activity.

Lay

**Physical assessment of male condition for removing males as part of a male reduction plan**

A planned mating ratio reduction program (**Table 17**) should be followed to maintain persistency of fertility. The optimum mating ratio is maintained by removing males from the flock that are in poor physical condition and not working.

**Table 17:** A guide to typical mating ratios as a flock ages.

Days	Weeks	Number of Good Quality Males/100 Females
154-168	22-24	9.50-10.00
168-210	24-30	9.00-10.00
210-245	30-35	8.50-9.75
245-280	35-40	8.00-9.50
280-350	40-50	7.50-9.25
350 to depletion	50 to depletion	7.00-9.00

Assessment of male condition for managing mating ratios should be routinely made during weighing, but can also be done on individual males when walking through the flock.

Physical assessment of male condition must be comprehensive and include:

- **Alertness and activity.**
- **Body condition (fleshing)** - shape and softness or hardness of breast muscle tone.
- **Legs and feet** - the legs should be straight with no bent toes, and the footpads should be free from abrasions.
- **Head** - males should have a uniform, intense red color around the comb, wattle, and eye area. Beaks should be uniform in shape.
- **Feathering** - a good quality male will exhibit some partial feather loss, especially around the shoulders and thighs.
- **Vent** - should show some feather wear, be large and moist, with good (red) coloration.
- **Body weight** - according to target.

**Alertness and activity**

The flock should be observed throughout the day to monitor mating activity, feeding, resting location, daytime distribution and distribution immediately prior to lights out. Males should be alert and active, and evenly distributed over the litter (scratch) area for most of the light period (**Figure 76**). They should not be concentrated on the slats or hiding under equipment. Males identified as not being alert and active should be removed. If the mating activity of the flock is observed to be lower than expected, the reason should be investigated (e.g. poor male condition, sexual maturity between males and females not synchronized, inadequate feed distribution, and male feed allocation).

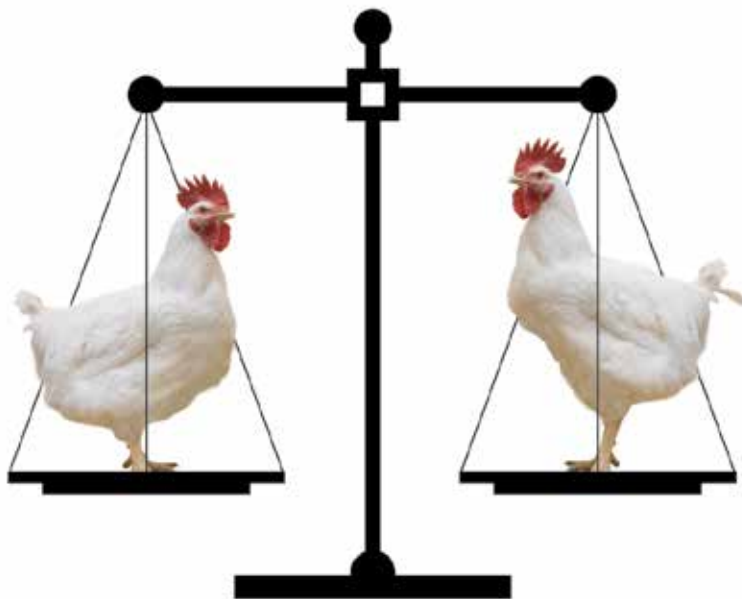
**Figure 76:** Good distribution of alert males within a flock.



**Monitoring body condition (breast shape or fleshing) in males**

Breast shape or fleshing is a good indicator of bird condition and is particularly useful for males. Birds that are over- or under-fleshed are more likely to have problems with mating and fertility at some point. Traditionally, body weight has been the main driver for male broiler breeder management decisions, but using body weight alone can be misleading. For example, it is possible to have two birds of the same age and body weight that differ in physical appearance and body condition (one could be skeletally smaller or larger, and broader or leaner - **Figure 77**). Such birds would require different management, for example feed levels and feeder height, to achieve good levels of fertility.

**Figure 77:** An example of two adult male birds of the same weight and age but differing body condition. The bird on the left is shorter and broader, and the bird on the right taller and leaner, but the body weight of the two birds is equal.



Observation and awareness of male condition are important throughout the bird's entire life. Achieving the optimum condition, maintaining it, and ensuring that there is no deterioration in it at any stage is key to male performance. However, particular attention is recommended:

- At the onset of physical mating activity to ensure that early flock fertility and productivity are maximized.
- Post-peak to optimize lifetime flock fertility.

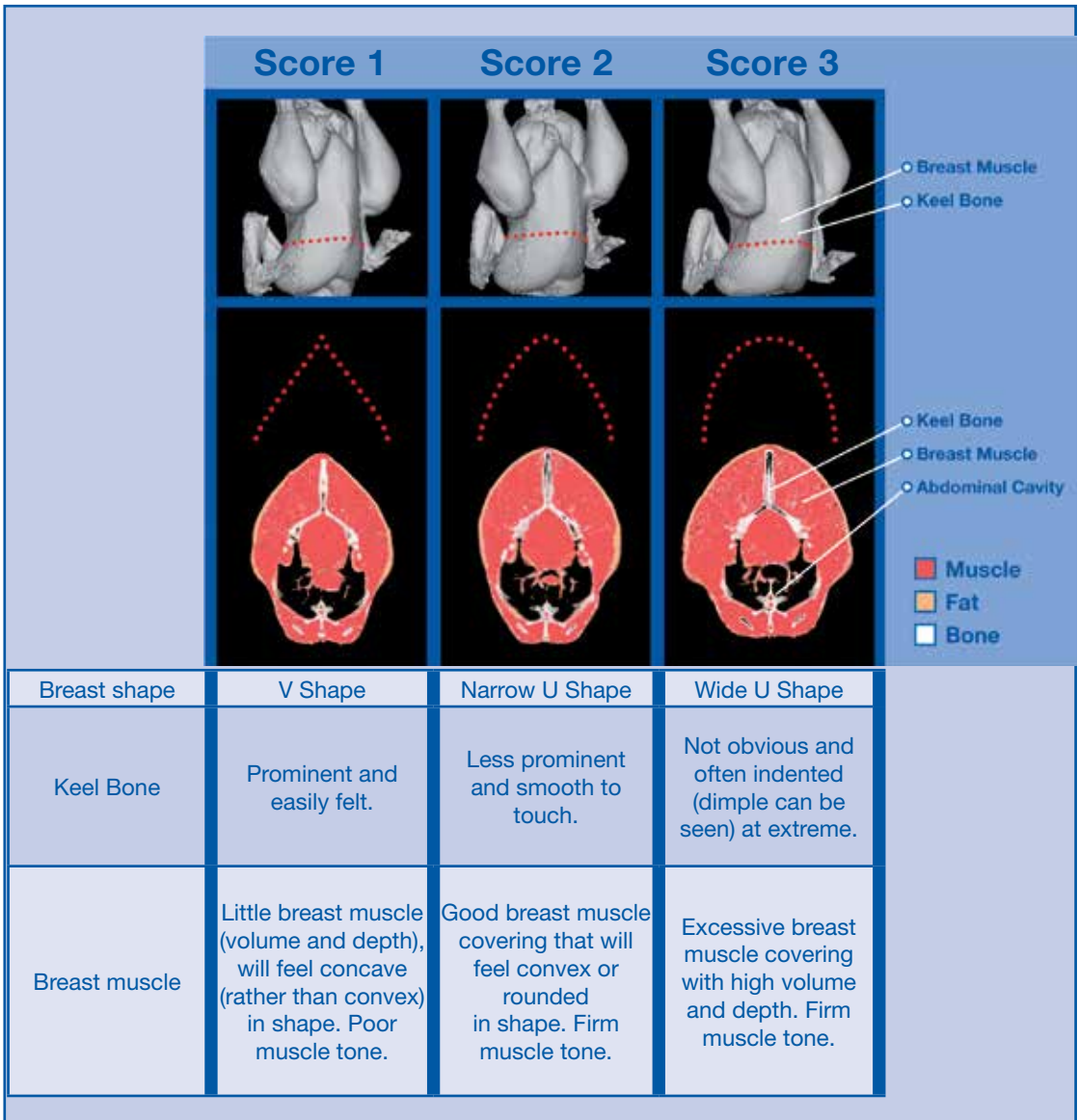
**Body condition scoring system**

Body condition (fleshing) should be assessed on a scale of 1 to 3; a score of 1 being under-fleshed, a score of 2 being ideally fleshed, and a score of 3 being over-fleshed. The differences between the 3 scores are illustrated in **Figure 79**. The images in **Figure 79** were taken using a CT (Computed Tomography) x-ray scanner (**Figure 78**), which allows the bird underneath the feathers to be viewed.

**Figure 78:** CT scanner used to take images that illustrate a scoring system to assess bird body condition (fleshing).



**Figure 79:** CT scanner images illustrating the fleshing scoring system for assessing bird condition. These pictures show 40-week-old males. The top three images show the whole bird (the dotted lines indicate the position at which the cross section images were taken). The bottom three images show an internal cross section view of the breast.



**Procedure for assessing body condition (breast shape or fleshing)**

Breast shape and fleshing should be assessed at least once a week during weighing. All birds being sampled weighed should be assessed.

To assess fleshing, run the hand along the length of the breast (over the keel bone), feeling the shape, volume, and tone of the breast muscle (**Figure 80**).

A score of 1, 2 or 3 indicating the amount and shape of breast should be given to each bird. Scores should be recorded, and the average score for the flock determined each week. The trend in bird condition over time should also be monitored.

**Figure 80:** Assessing male condition. While holding the bird by both legs, the hand is run over the keel bone, and the prominence of the keel bone, and the amount, shape, and firmness of the breast on either side of the keel assessed. The male in the picture is 26 weeks old and the keel bone should be easily felt (but not prominent). The breast should be firm and rounded to touch, filling the space on either side of the keel bone (condition score 2).



Body condition scores should be taken into consideration, along with body weight and uniformity, to provide the basis for appropriate adjustments in bird management. Examples of how body condition assessments might be used in this way are given in **Table 18**.

**Table 18:** Examples of how male condition can be used in conjunction with body weight to determine appropriate flock management strategies.

	Flock Age	Average Body Weight	Average Condition Score Week 38*	Average Condition Score Week 39*	Average Condition Score Week 40*	Management Strategy
Sample 1	40 weeks	Target	2.0	2.0	2.2	Body weight on target, condition good. Give recommended feed increase.
Sample 2	40 weeks	Target	2.0	1.8	1.7	Body weight on target but condition score falling. Consider giving additional feed increase above recommendation, and investigate reason for declining condition.
Sample 3	40 weeks	200 g (0.4 lbs) below target	1.9	1.8	1.4	Body weight below target, condition score low (thin birds). Check condition score is correct. If confirmed, give additional feed increase. Investigate feed volumes, uniformity of feed distribution, and effectiveness of separate-sex feeding.
Sample 4	40 weeks	200 g (0.4 lbs) above target	2.0	2.2	2.5	Body weight over target and condition score high (fat birds). Verify that feed distribution and separate-sex feeding systems are working optimally. Feed to maintain increased body weight.

\* Average condition score corresponds to group of males sample weighed.



Ideally, body condition should be assessed by the same person each week as interpretation of the assessment of body condition score will differ slightly between individuals. In addition, while the average condition score for the males in a flock is 2, the optimum condition score for individual flocks may vary slightly around the ideal.



- Body condition (fleshing) should be assessed at least weekly during weighing.
- All birds being weighed should be assessed and their condition given a score of 1, 2 or 3 (1 being under-fleshed, 2 being ideal and 3 being over-fleshed).
- Condition scores should be recorded and the average for the flock calculated. The trend over time should also be monitored.
- Body condition should be used in conjunction with body weight and uniformity to determine appropriate management and feeding strategies.

### Legs and feet

To maintain high fertility levels within a flock, males must have good feet and legs (**Figure 81**). Legs should be straight with no bent toes. The footpads should be clean and free from physical damage. Abrasions and cracks on the feet may lead to infection and discomfort that will reduce welfare and mating activity. Any male showing poor feet and leg condition should be removed from the flock.

**Figure 81:** Good leg health in males.



### Head

Males in good condition that are working well will have a uniform, intense red color around the comb, wattle, and eye area (**Figure 82**). Under normal conditions, the face of a healthy, well-conditioned male will redden up from the face in towards the eye. Conversely, the face of a male in poorer condition will start to lose color from the eye outwards. Males with low face color may have a low mating activity and should be considered for removal.

**Figure 82:** A healthy, active male showing a red face and comb (left), and a male in poorer condition, showing paleness around the eye (right).





**Feathering**

In production, a good-quality male that is working well will exhibit some partial feather loss, especially around the shoulders, thighs, breast, and tail (**Figure 83**). Well-feathered males generally have low mating activity and should be considered for removal.

**Figure 83:** An active male showing some feather wear (left), and an inactive male showing no feather wear (right).



**Vent (cloaca) condition**

During weekly weighing, male vent condition should be assessed. Assessing the intensity of redness and moistness of the vent (**Figure 84**) is a useful management tool for assessing male condition and mating activity within the flock. The aim is to maintain a uniform high coloration of the vent within the flock. Healthy, well-conditioned males working at optimum rates will demonstrate a redder vent color. The vent will be moist, and there will be some feather loss around the vent area. Males of poor condition with low mating activity will have pale vent color. The vent will be small and dry with good feather cover.

**Figure 84:** Variation in vent color used to indicate degree of mating activity in males. The vent on the left is from a working male and has a good red color, is moist and shows some sign of feather wear. The vent on the right is pale in color, small, dry, and shows no sign of feather wear.



**Other Useful Information Available**

*Aviagen Poster: Male Management - Physical Condition in Lay*



- During lay, a male reduction plan must be followed to maintain optimal flock fertility.
- The decision about which males should be removed from the flock is based upon a general assessment of male physical condition.
- Attributes that should be looked at include:
  - « Body weight.
  - « Body condition.
  - « Legs and feet.
  - « Face color.
  - « Vent condition.
  - « Alertness and activity.

### Assessment of Female Condition

The weekly sample weighing also provides an ideal opportunity to assess female physical condition. As with males, it is good management practice to pick up and assess the condition of individual females while walking through the flock.

Any personnel handling birds should do so with due care and attention, and must be appropriately trained.

#### Rear

In rear, assessment of bird physical condition is based primarily on body-weight monitoring and skeletal size (skeletal frame size and shank length). However, it is also important to be aware of degree of fleshing, general health, alertness, and activity. Achieving uniform growth and development of the females during rear is key to subsequent laying performance. Variation in frame size within the female population can provide a visual indicator of poor flock uniformity (determination of body weight CV% should be used to confirm this). When poor flock uniformity occurs, the cause (s) should be identified (e.g. poor feed distribution, inadequate feeder space, disease, poor brooding conditions).

#### Lay

During lay, the main drivers for decisions on feeding management for females are body weight, egg production, and egg weight. Regular monitoring of pin-bone spacing, fleshing, and fat-pad development can provide useful supportive management information.

#### Pin-bone spacing

Measurement of the spacing between the pin (pelvic) bones is a useful management tool for determining the stage of sexual development in growing females, and hence, when lay is about to commence. Under normal conditions, the spacing between the pin bones will gradually increase as the bird ages until it becomes maximal at point of lay (**Table 19**). If pin-bone spacing does not develop as indicated in **Table 19** (i.e. is below 1½ fingers at the intended age of light stimulation), or if there is a big variation in pin-bone spacing within the flock, then light stimulation should be delayed.

**Table 19:** Changes in pin bone spacing with age.

Age	Pin Bone Spacing
84-91 days	Closed
119 days	1 finger
21 days before first egg	1½ fingers
10 days before first egg	2-2½ fingers
Point of lay	3 fingers

Pin-bone spacing should be monitored regularly from 15 to 16 weeks (105 to 112 days) of age up to point of lay (**Figure 85**). Ideally this should be done every time the house is walked, but at a minimum it should be done weekly. The term "finger" is relative to the operator's hand size and so will vary from person to person. Ideally, it should be the same person who measures pin-bone spacing from week to week. As a general rule, birds are at the point of lay when the distance between the pin bones is about 3 fingers (or approximately 5-6 cm [2-2.5 in]). A thin layer of fat covering the pin bones indicates that the birds are laying down abdominal fat in readiness for the onset of lay. No fat covering may indicate that the birds are not ready to be light stimulated.

**Figure 85:** Assessment of pin-bone spacing in females.



#### Other Useful Information Available

Broiler Breeder Management How To: *Measure Pin Bone Spacing*

#### **Monitoring body condition in females**

In general, a uniform flock of females achieving the target body-weight profile in rear should also achieve an acceptable body condition.

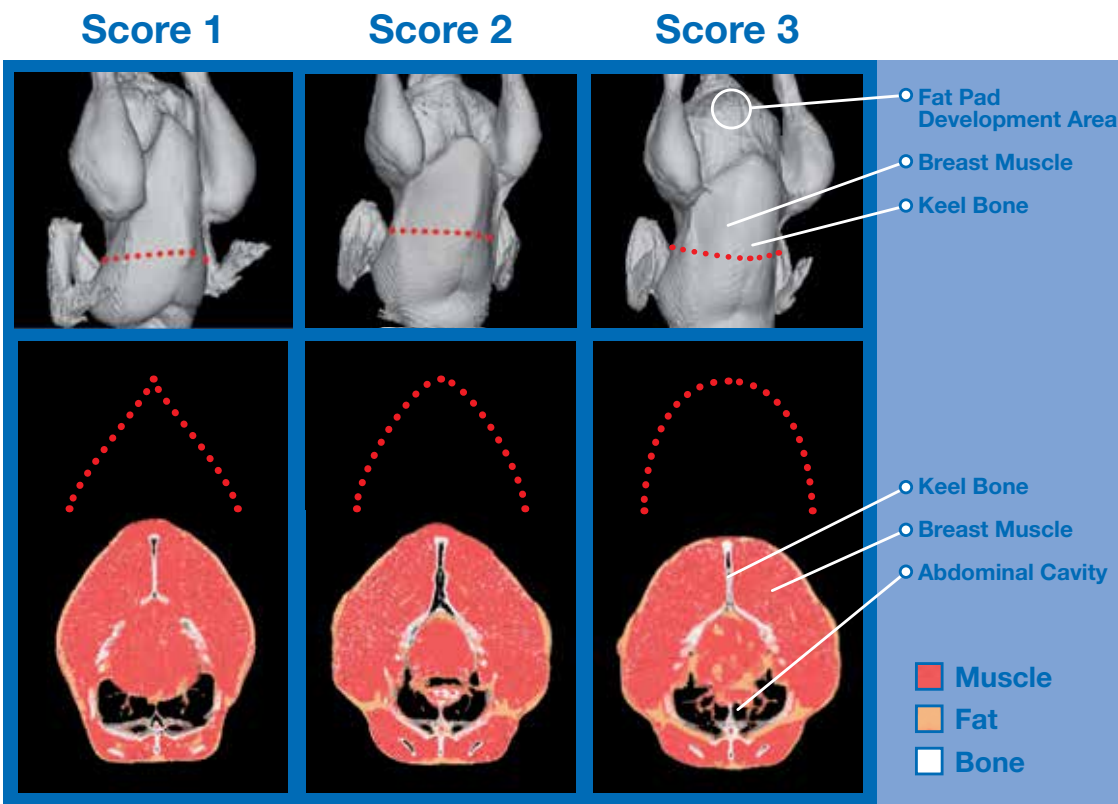
It is important to ensure that females do not become either over- or under-fleshed. Regardless of age, females that are substantially over-fleshed are likely to be heavy and have increased fat deposits, while under-fleshed females are likely to be in poor condition. Both situations impact lifetime reproductive performance. As is the case for males, a sample of females should be handled frequently (at least weekly), and body condition (fleshing) assessed to ensure that the flock remains in good health and condition to maintain reproductive performance.

The same scoring system used for males should be used for females (**Figure 86**). However, the way in which the flock results are interpreted and used are different as the female body shape differs to that of males and it is not recommended to remove individual females from a flock based on this assessment. For females, it is critical to achieve target body weights and modify feed allocation appropriately to egg production levels, and egg weight. Fleshing assessment in females tends to be a supportive management tool (rather than pivotal, as is the case for the males in lay).

In rear, the appropriate flock management should minimize the incidence of score 1 (under-fleshed) and score 3 (over-fleshed) birds in the flock.

In lay, it is preferable that the average flock score is between 2.0 to 2.5, and that the occurrence of score 1 females is minimized because under-fleshed females are likely to have lower egg outputs. However, a body condition score 3 can be satisfactory for females in lay, as a fleshy female can still have a good reproductive output.

**Figure 86:** CT scanner images illustrating the fleshing scoring system for assessing bird condition. These pictures show 40-week-old females. The top 3 images show the whole bird (the dotted lines indicate the position at which the cross section images were taken). The bottom 3 images show an internal cross section view of the breast.



Section 5

**Abdominal fat pad**

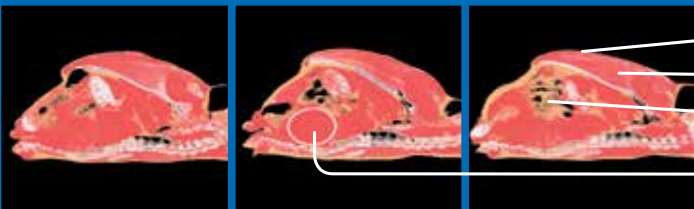
In lay, monitoring fat pad deposition (**Figure 87**) is another supportive management tool that can help provide a better overall assessment of bird condition.

**Figure 87:** Assessing abdominal fat pad in a female broiler breeder. To assess abdominal fat pad content, gently feel the area just below the cloaca with a cupped hand. Post-peak abdominal fat pad should not exceed the level shown here.



There is little fat pad development in properly fleshed broiler breeders prior to onset of lay. Significant development of the fat pad generally occurs after sexual maturity is attained, with the fat pad reaching its maximum size about 2 weeks before peak egg production. The abdominal fat pad in females can provide an energy reserve to support maximum egg production, but any excess fat, particularly after peak, will be detrimental to persistency of egg production, fertility, and hatchability, and it may reduce liveability. A positive relationship exists between body weight and fat pad development so heavier females are likely to have increased fat levels that may affect productivity (**Figure 88**).

**Figure 88:** Increases in fat pad with weight. The pictures show a longitudinal cross section (cloaca on left, head [not shown] on right) of three females. The birds were 40 weeks of age. The female on the left is losing condition and is below target weight with little fat. Egg production in such a bird is likely to be reduced or even cease. The bird on the right has a large fat pad and shows fat accumulations around the internal organs. Rate and persistency of lay are likely to be reduced in this bird.

Increases in Fat Pad				<ul style="list-style-type: none"> <li>○ Keel Bone</li> <li>○ Breast Muscle</li> <li>○ Abdominal Cavity</li> <li>○ Egg</li> </ul>
	Live weight	3314 g 7.3 lbs	3666 g 8.1 lbs	
Difference to target weight	-336 g -0.74 lbs	+16 g +0.04 lbs	+97 g +0.21 lbs	
Fat pad weight	42 g 0.09 lbs	71 g 0.16 lbs	104 g 0.23 lbs	
Fat pad as a percentage of live weight	1.3%	1.9%	2.8%	

From the start of lay, females should be routinely (at least weekly) assessed to monitor the progress of fat pad development. The actual degree of fat pad deposition will vary from bird to bird. The objective after peak production is to maintain the female at physical mature weight but to minimize the development of excess fat pad. As a guide, maximum fat pad volume should be no more than the size of an average person's cupped hand or a large egg (roughly 8-10 cm [3-4 in]).



- Regular assessments of female physical condition (fleshing) should be made throughout the life of the flock.
- Using a combination of physical assessments (body weight, fleshing, fat pad, and pin-bone spacing) provides a reliable indication of overall female condition upon which appropriate management decisions can be based.

## Section 6 - Care of Hatching Eggs on Farm

### Care of Hatching Eggs

#### Objective

To keep the embryo and egg contents in the best possible condition for good hatchability and chick quality.

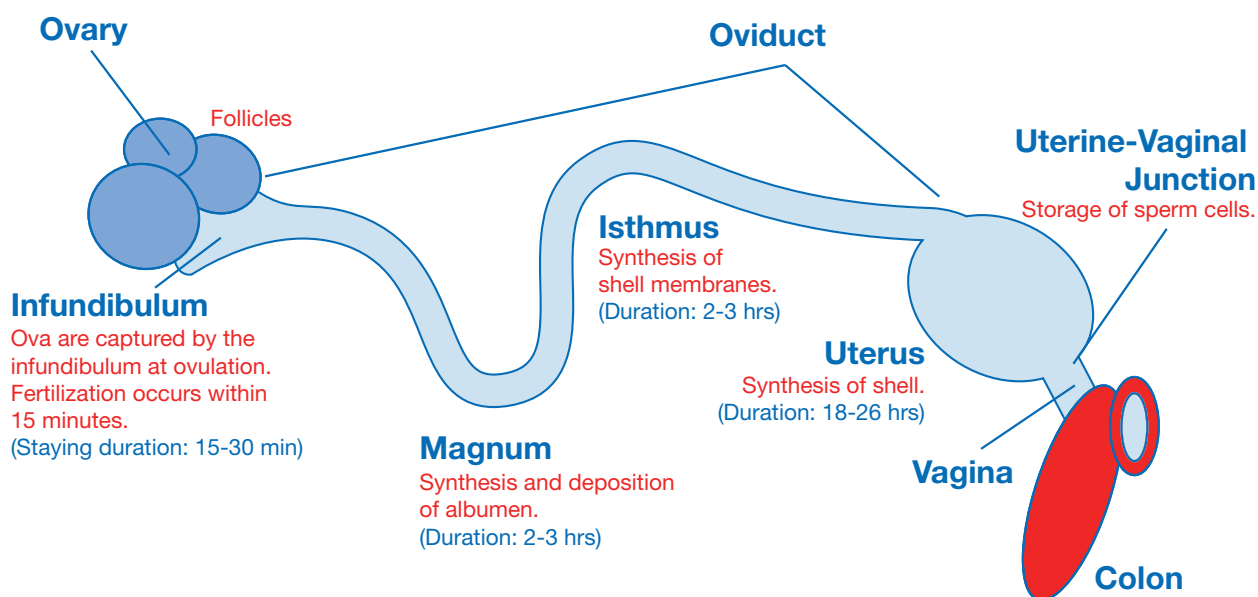
#### Principles

Eggs must be kept in clean conditions and at the correct temperature and humidity to achieve the best hatchability. Satisfactory procedures for collection, disinfection, cooling, storage, and incubation of the eggs should be in place, and each process should be carried out so that embryonic development is not compromised.

#### Why Do Hatching Eggs Need Care?

Fertilization takes place at the top of the oviduct shortly after the yolk is released from the ovary. The yolk then passes down the oviduct (**Figure 89**). As it does so, the outer layers of the egg are laid down, and the fertilized germinal disc grows and develops. By the time the egg is laid, it contains a germinal disc that has been growing for 24 hours as the egg is formed around it (**Figure 90**).

**Figure 89:** A diagram showing the ovary and oviduct. Key events are labelled.



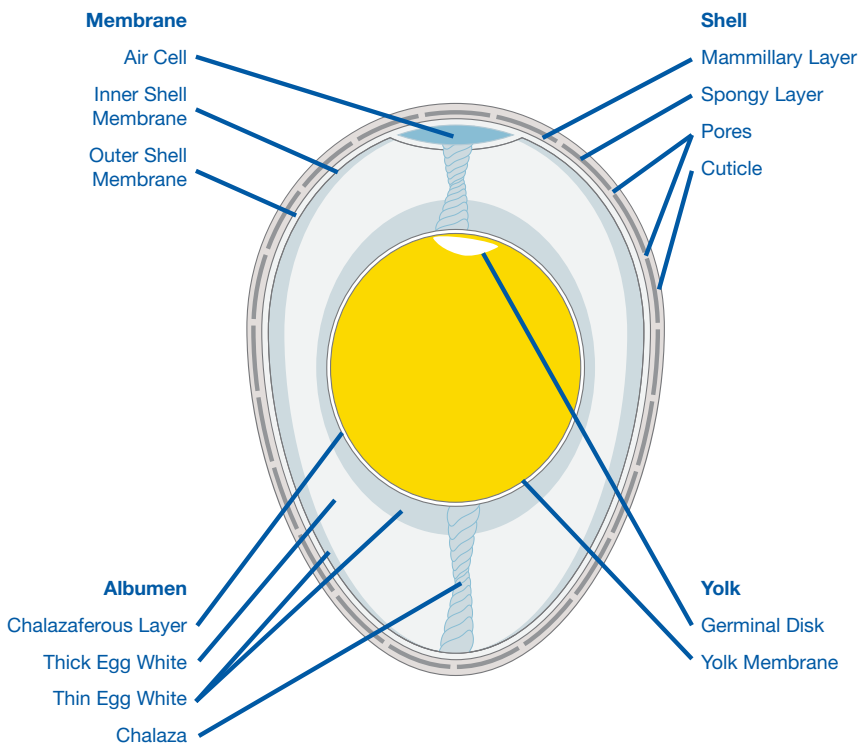
After the egg is laid, it must be cooled to suspend any further development until the egg is set at the hatchery. The care given to hatching eggs has to meet the needs of these dormant (but living) embryos. The egg components surrounding them have to be maintained in good condition. Uncontrolled fluctuations in egg store temperatures will cause stop-start growth of the germinal disc, which will reduce hatchability. Recent studies have shown that if eggs are to be stored for more than a week, it can be beneficial to warm them up to incubation temperature for short periods during storage.



## The Egg's Protection System

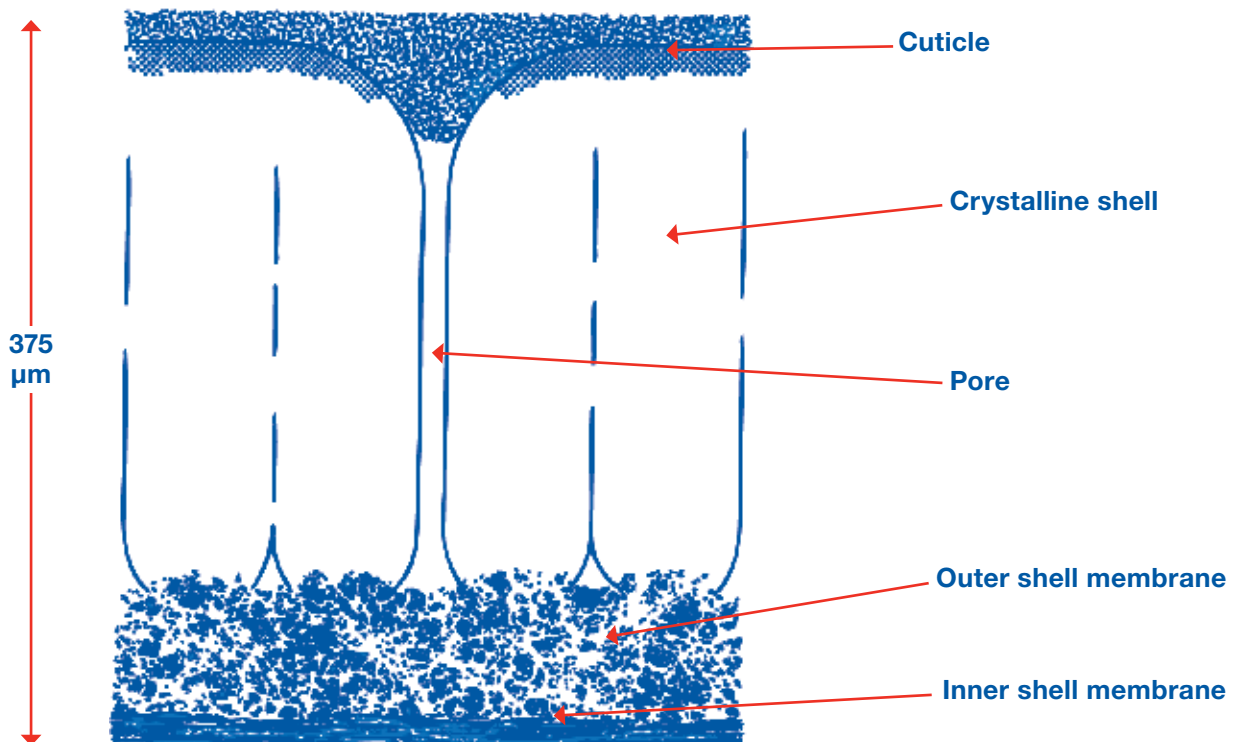
The egg provides a multi-layered system of protection from microbial contamination (**Figure 90**). The cuticle, egg shell, shell membranes, and some of the proteins in the albumen act as either physical or chemical barriers to prevent microbes gaining access to, and growing in, the egg contents.

**Figure 90:** Internal structure of a fertile egg at the time of lay.



The shell of the egg is a porous structure. Pores run from the surface right through the shell (**Figure 91**). These pores are needed to allow oxygen into, and water and carbon dioxide out of, the egg as the embryo develops.

**Figure 91:** Cross section showing the structure of the egg shell.



The entrance to the pore on the egg shell surface is protected by the cuticle. The cuticle is a thin protein coat that allows gases, but not micro-organisms, through. This coating provides the egg contents with some protection from microbial penetration. However, the cuticle does have one point of weakness. Immediately after the egg is laid, it is still not completely formed (this is why the shell surface looks wet and under magnification, it has an open, sponge-like appearance). The cuticle hardens to a flatter, flake-like surface within 2-3 minutes of the egg being laid. Until this process is complete, it is easy for microbes to penetrate the cuticle and then pass down the pores and into the egg (**Figure 92**).

**Figure 92:** Example of bacterial penetration that can occur immediately after laying through the pores of dirty egg shells.



*The photograph shows the inner egg shell surface of a soiled egg. The egg contents were removed through a small hole at the small end, replaced with a nutrient gel and incubated. Bacterial colonies show up in red.*

Understanding the structure of the egg shell helps to explain why certain procedures used on the farm to clean eggs can make contamination problems worse. For example, if slightly soiled eggs are buffed or scraped to remove the surface dirt from the shell, some of the dust that this produces will be packed into the shell pores and block them. Blocked pores will impair gas exchange, and as a result, limit the oxygen available to the developing embryo. More importantly, pores blocked with contaminated material will increase the risk of contamination. In addition, buffing or scraping the shell surface will remove the protective cuticle, making it easier for bacteria to enter the egg.

Contamination problems can also be made worse if the eggs become wet after collection for any reason. Liquid will run into the pores of the shell, carrying any bacteria on the shell surface with it. This is especially likely to happen if the egg contents are cooling. Cooling creates a partial vacuum within the shell, making it more likely that any surface liquid (and microbes) will be drawn in through the pores and is why condensation on the egg shell causes so many problems.



- Eggs should be maintained in a clean state between lay and packing.
- Methods used to remove surface dirt should be gentle so as not to damage the cuticle or block the egg shell pores.
- Condensation on the egg surface should be avoided as it can lead to contamination problems.

## Best Practice for Care of Hatching Eggs

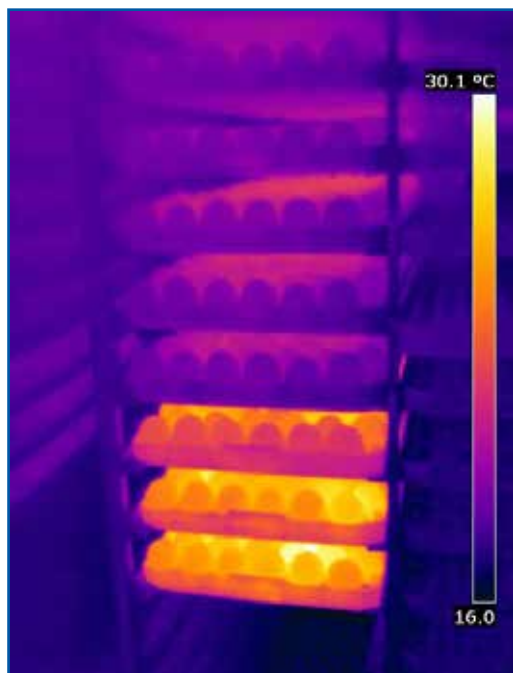
### Egg Collection

- Manage the flock to minimize the number of eggs laid on the floor (see section on *Management into Lay*).
- Keep the insides of the nests and any collection belts free of litter and droppings. As a minimum, nests and collection belts should be brushed clean at least once a week and checked for dead birds daily. Collect nest eggs a minimum of 4 times a day, adjusting the exact timings so that no more than 30% of the eggs fall in any one collection (any more will increase the incidence of dirty or cracked eggs). The majority of the eggs will be laid in the morning and collection intervals should be managed accordingly. The nests and egg collection belt should be cleared at the end of the working day to minimize the number of eggs left over night.
- Collect floor eggs separately. They should be collected as often as possible (more often than nest eggs) and should be kept separately from nest eggs so that the hatchery can manage appropriately the contamination risk they present.
- Monitor the numbers of floor and dirty eggs and adjust management factors to minimize them (see section on *Management into Lay*).

### Egg Packing and Selection

- If eggs are being packed straight on to setter trays, select and pack the eggs immediately after each collection.
- If eggs are to be boxed, they should be cooled to egg store temperature prior to boxing. Reject small eggs (minimum weight will be an economic decision), cracked or damaged eggs, eggs with gross shell abnormalities, double-yolk eggs, soft-shelled eggs, and any eggs that are more than 25% covered with dirt or droppings (or exceed levels of soiling stipulated by hatchery or regulatory requirements). Record numbers rejected in each category and monitor them.
- Avoid wet egg disinfection methods - fumigation with formaldehyde is best.
- If eggs do become wet, let them dry before fumigating them or placing them in a cold egg store.
- Immediately after each tray of eggs is packed, place it in a rack in the egg store. Trolleys should be packed from the bottom up. This order of packing will avoid re-warming cooled eggs by placing warmer eggs beneath them in the trolley (**Figure 93**).
- Once an egg trolley has been placed in the egg store, it should stay there. Fill a partial trolley by taking trays of eggs into the store to finish loading, not by taking the trolley out of the store.
- Eggs or trolleys should not be wrapped in plastic until they have cooled to egg store temperature.

**Figure 93:** Hatching eggs incorrectly stored in a trolley.



*The thermal image shows freshly collected, warm eggs being placed below already cool eggs collected earlier. This is not good practice. Trolleys should always be filled from the bottom so that fresh eggs are stored above cooled eggs.*

### Egg Disinfection

Fumigation with formaldehyde remains the most effective (and preferred) method for disinfecting the shell surfaces of hatching eggs. Provided fumigation is performed correctly, it achieves excellent kill rates of micro-organisms on the shell surface without wetting the shell, damaging the cuticle, or damaging the embryo inside the egg. Despite its effectiveness, some countries now prohibit the use of formaldehyde because of the potential risk to human health and safety if it is not used correctly.

Many different chemicals and application methods have been investigated as alternatives to formaldehyde fumigation. None have proven to be as effective, either because they kill a more limited range of micro-organisms, because they have to be used in solution, because they damage the cuticle, or because they are detrimental to embryo survival. Follow these guidelines when using formaldehyde:

- Follow the appropriate safety precautions when using formaldehyde. Always adhere to local rules governing the health and safety of farm workers when using formaldehyde.
- Fumigate eggs with formaldehyde at least once before they leave the farm.
- Make sure that the eggs are well separated on plastic egg or setter trays; cardboard tends to absorb the gas.
- Ensure the fumigation room is well sealed during fumigation and allow at least 20 minutes for the gas to circulate after it has been generated.
- Heat 43 ml formalin (37.5%) per m<sup>3</sup> (1.5 oz per 11 ft<sup>2</sup>) of fumigation room.
- Ensure room temperature is a minimum of 24°C (75.2°F).
- Ammonia can be used to neutralize the formaldehyde before the cabinet is exhausted.
- Run a circulating fan during fumigation to help circulate the fumigant gas between the eggs; switch the fan off before exhausting the formalin at the end of the disinfection period.
- Make sure that all the gas is completely exhausted from the room before workers re-enter to move the eggs. This step is less urgent if the gas is neutralized first, but should be re-checked periodically using an appropriate meter.

### Assessing Alternatives to Formaldehyde

Where formaldehyde fumigation is not permitted due to local health and safety regulations, alternative methods of disinfection need to be found. Many alternatives to formaldehyde have been tested over the years. All have disadvantages, and most have to be used with the same due care and attention to operator safety as formaldehyde.

There are many products sold as being suitable for disinfecting hatching eggs (including hydrogen peroxide, peracetic acid, quaternary ammonium and chlorine disinfectants). Before implementing any new method or chemical for disinfecting hatching eggs, it is strongly advised that their effectiveness is thoroughly tested, making sure to closely follow the advice of the equipment and chemical suppliers.

Factors to consider when testing alternatives to formaldehyde include:

- The egg shell bacterial counts before and after treatment.
- Egg content bacterial counts after treatment.
- Impact on cuticle cover (which can be seen under UV light).
- Hatchability.

Hatchability tests should involve at least 1,000 eggs per treatment group, split from a single collection of eggs. Half the eggs should be treated according to current methods, and the other half by the proposed new treatment. The test should be repeated over a range of flock ages and egg storage durations.

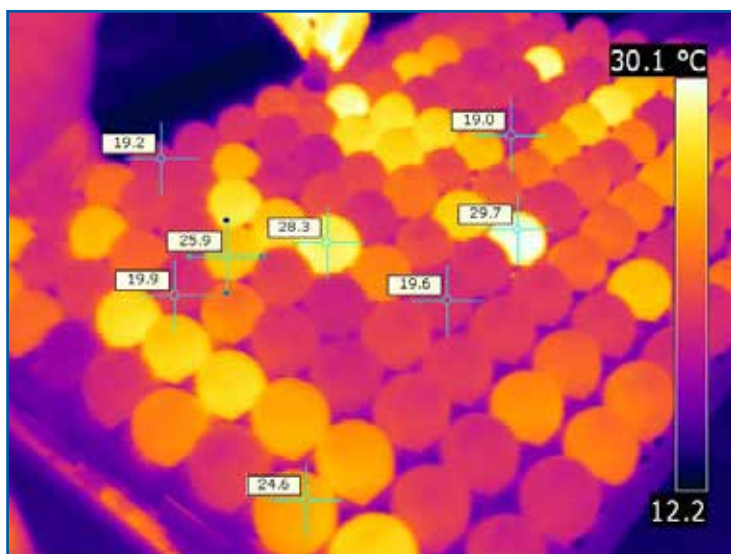
### Cleaning Soiled Eggs

Provided any surface dirt is not extensive, it can be removed by gently flicking the dirt off with a finger nail, or for soft droppings, by gently wiping off with a clean paper towel. Care should be taken not to contaminate clean parts of the egg. The eggs should then be disinfected (ideally by fumigation with formaldehyde) and sent to the hatchery clearly marked as dirty.

The washing of hatching eggs is not good practice. But under some conditions, washing eggs may be unavoidable. If washing eggs is necessary, the following applies:

- Use a washer that sprays the eggs with warmed disinfectant solution, rather than one that relies on the eggs being immersed in the solution.
- Wash water should be 41°C (106°F) to ensure that the wash water is always warmer than the warmest eggs in the collection (**Figure 94**).
- Record and monitor the process, taking care to monitor temperatures and the frequency with which the washing water is changed.
- Make sure that the disinfectant concentration does not fall below the recommended minimum effective concentration level and that the washer solutions are replaced after each batch of eggs to maintain disinfection concentration.
- Allow the eggs to dry before they are cooled in the egg store.
- Fumigate washed eggs when they are dry.

**Figure 94:** Range of egg temperatures in eggs collected at second egg collection - all the eggs had been laid within the previous 2 hours.



*The thermal image shows the range of temperatures of eggs collected from a colony-type auto nest. It is **not** safe to assume that eggs are uniformly cold when deciding a suitable wash temperature for cleaning soiled eggs.*

### Egg Storage Conditions

After the egg is laid, it should be cooled so that cellular growth of the embryo is suspended. Ideally, hatching eggs should all be set within 7 days of lay. Storage for longer than 7 days will result in a loss of hatch due to embryo cell death and a decline in internal egg quality, especially albumen quality. When longer storage is unavoidable, a cooler storage temperature will help to keep the yolk and albumen in good condition.

#### Temperature

- Keep egg temperature constant once the eggs are cooled and watch for variable storage temperatures throughout the day and when doors are left open. It is important to coordinate temperatures with those used in transport to, and storage at, the hatchery. This will avoid fluctuating temperatures and condensation.
- Storage temperatures need to be set at a level that will maintain internal egg quality and keep the dormant embryos alive - long storage should be at lower temperatures than short-term storage (**Table 20**).
- On farm storage temperatures should be managed so that the temperatures are adjusted when the average storage duration changes.
- Keep the farm store 2°C (4°F) warmer than the hatchery store, with the truck temperature intermediate between the two. This will help to avoid any condensation forming on the eggs.
- Do not blow cooler or heater fans towards eggs.
- The eggs do not need a sequence of different temperatures at the hatchery. For example, if a batch of eggs is to be stored for 14 days, embryo survival will be best if they are held at 15°C (59°F) or less for the whole storage period.
- For storage over 14 days, 12°C (54°F) can work well, but only if great care is taken to avoid condensation when eggs are moved to a warmer environment.



**Table 20:** Relationship between length of egg storage and temperature of egg store.

Storage Period (days)	Temperature of Storage* °C (°F)
1-3	20 (68)
1-7	15 (59)
> 7	15 (59)

\* Humidity between 70 and 80%

**Humidity**

- Ideally, egg store humidity should be held between 70 and 80% RH, to prevent the eggs losing too much moisture during storage.
- If cold eggs are moved into a warm, humid atmosphere, condensation will form on the egg surface, as shown in **Figure 95**. For more information refer to the Dew Point or Condensation Table in **Appendix 5**.
- Make sure that the water in the humidifier is clean (static reservoirs can encourage bacterial growth) and that spray nozzles are maintained properly so that they produce a fine mist of water and not large droplets.

**Figure 95:** Condensation on the surface of the egg.



- Nest cleanliness and regular/frequent egg collection are extremely important. Any egg laid onto dirt or droppings will become contaminated.
- There will be microbes even on the shells of clean hatching eggs. Unless there is effective disinfection of the egg shell surface before eggs arrive at the hatchery, they present a risk to hatchery hygiene and embryo survival and health.
- Formaldehyde fumigation is the best method for disinfecting egg shells. Ensure that temperature, humidity, and air circulation are appropriate for effective fumigation.
- Follow safety procedures.
- If an alternative to formaldehyde does need to be used, to be comparable to formaldehyde fumigation, the new method should kill 99% of shell surface bacteria, viruses and molds; give no increase in egg content bacterial counts; cause no or minimal cuticle damage, and give the same or better hatchability in both young and older flocks and after long egg storage.
- Monitor and record egg washing procedures. If the recommendations for washing eggs are not achieved, the level of rots and contamination in the washed eggs will be high, with poor hatch and chick quality.
- Adjust on-farm storage temperatures for the oldest eggs. Fresh eggs will hatch normally if kept at lower temperatures, whereas the hatch of longer-stored eggs will suffer if kept too warm.
- If there is condensation on the eggs, do not fumigate them and do not put them into the cooler until they have dried.

### Problems Resulting in Rots and Bangers

If the hatchery is experiencing an excessive number of rots and bangers, check the following:

- The number and severity of dirty eggs being produced. Make sure nests and collection belts are checked regularly and cleaned immediately if a problem is spotted.
- That floor eggs are not washed and then mixed with nest eggs.
- That eggs are not collected or packed into dirty trays.
- That the shell quality (increase in rejected or cracked eggs) is normal for the age of the flock. Shell quality can be damaged by inappropriate feed or respiratory diseases and will show up as a sudden increase in rejected and/or cracked eggs.
- That egg washing and disinfectant media are 41°C (106°F).
- That washed eggs are not mixed with clean eggs.
- That wet eggs are not being placed in the egg store.
- Condensation on the egg surface as this will increase rots and bangers.

On-farm humidification is not necessary and needs a great deal of care and attention to make sure that it is not a cause of contamination.



- If there is an excessive number of rots and bangers in the hatchery, investigate potential causes and take required action.

### Longer Periods of Storage

Broiler hatching eggs should normally be set before they are 7 days old. If longer storage is unavoidable, hatch can be improved by using short periods of incubation during egg storage (SPIDES).



#### Other Useful Information Available

Hatchery How To: *Improve the Hatchability of Stored Eggs*

Aviagen Poster: *Egg Quality from Nest to Setter*



## Section 7 - Environmental Requirements

### Housing

#### Objective

To provide a protected environment in which temperature, humidity, ventilation, daylength, and light intensity can be controlled and optimized for the lifetime of the flock in order to achieve good reproductive performance without compromising health and welfare.

#### Principles

Farm location and house design must take into consideration climate and management systems.

#### Farm Location and Design

The location and design of a farm (**Figure 96**) will be affected by a number of factors, not least by local economics and regulations.

**Figure 96:** Examples of typical farm layouts and locations showing good biosecurity.



#### Climate

Temperature and humidity ranges experienced in the natural climate will influence which type of housing is most suitable (i.e. open or closed) and the degree of environmental control required.

#### Local Planning Regulations and Laws

Local planning regulations and laws may stipulate important constraints in design (e.g. height, color, materials), and should be consulted at the earliest opportunity. Local law may also dictate a minimum distance from existing farms.

#### Biosecurity

The size, relative situation and design of houses should minimize the transmission of pathogens between and within flocks. A policy of single (as opposed to multi-) aged sites is preferable. House design must facilitate effective cleaning-out procedures between flocks (see section on *Health and Biosecurity*).

#### Access

The farm location must allow for easy access to the site perimeter by heavy vehicles such as feed and egg trucks (i.e. road widths and turning circles must be appropriate for the vehicles servicing the farm).

### Local Topography and Prevailing Winds

These natural features have particular importance for open-sided housing. They can be exploited to minimize the entry of direct sunlight and for optimal ventilation or cooling. Open-sided houses should be positioned so that the length of the house is oriented in an east/west direction to minimize solar heat gain through the side wall. The existence of sites nearby, which present an airborne disease risk, must also be taken into account. It is best to build a farm in an isolated area at least 3.2 km (2 miles) from the nearest poultry or other livestock facility that may contaminate the farm.

### Power Availability and Costs

Controlled environment housing requires a reliable source of power to operate electrical ventilation, heating, lighting and feeding equipment. It is essential to have a back-up system/generator (**Figure 97**) and an appropriate alarm system installed in case of power failure.

**Figure 97:** Example of a back-up generator.



### Water

A clean, fresh supply of water is required. For more information on maximum acceptable concentrations of minerals and bacteria in the water supply, see *Health and Biosecurity* section.

### Drainage

Farm design features should allow for the separate disposals of rainwater and house cleanout water. This separation is a necessary part of biosecurity and environmental protection, being increasingly a regulatory requirement (refer to local legislation).



- Farm design will depend on location, climate, and local planning regulations.
- Farm location checklist:
  - ✓ Availability of power and water.
  - ✓ Local topography and prevailing winds.
  - ✓ Access.
  - ✓ Biosecurity.

## House Design

### Controlled Environment

Controlled environment (blackout) housing is preferred over open-sided housing, in particular during rear, since it limits variation due to environmental influences, permits greater control over daylength, facilitates control of maturity and body weight, and assists in the production of uniform flocks.

### Fire Prevention/Control

House design should be planned in such a way to minimize fire risk.

### Size and Number of Houses

In determining the size and number of both rear and laying houses, the following should be considered:

- The number of eggs required per week.
- The number of birds required to achieve this level of production.
- The floor area required for this number of birds at the recommended stocking density.
- The pattern of egg production throughout lay.
- The time required for house cleaning and disinfection.
- The preferred/optimum individual house size, determined by the need to maintain the birds in an appropriate environment by managing the ventilation within the house effectively.
- The number of houses that the site can accommodate.

### Stocking Density

Stocking density will depend on local welfare legislation, climate, equipment, and local economics. Recommended stocking densities can be found in the sections on *Rearing* and *Management into Lay*.

### House Size

The house size selected must enable all of the daily feed allowance to be distributed evenly and be accessible to all birds within a maximum of 3 minutes. This condition should be met for each pen/population within the house.

### Lighting

Light should be uniformly distributed throughout the house. Light intensities and durations must achieve recommendations (see section on *Lighting*). Both should be controllable and adjustable. A light meter can be used to measure light intensity across the house at bird height.

### Light Proofing

Ventilation system design should include appropriate provisions for light proofing. Effective light traps should be fitted to all air inlets as well as fans. Light proofing is restrictive to air flow, and incorrectly designed/sized light proofing can be detrimental to the performance of the ventilation system and hence to the well-being of the birds.

Light intensity should not exceed 0.4 lux (0.04 fc) during the dark period (see section on *Lighting*). This light intensity must be achievable at all stages of ventilation system operation.

### Insulation

Insulation aids the effective operation of the ventilation system. The amount of insulation required will depend largely on the local ambient conditions in summer and winter and is subject to local legislation.

### Air Tightness

Most modern housing utilizes negative pressure ventilation. In order for the ventilation system to work effectively, the house must be well sealed to prevent any uncontrolled air leaks into the house (i.e. the house must be airtight). Consider air tightness during the design and construction of the house. In particular, give care to the tunnel ventilation inlet, as this is often the area of the house that has the most air leakage.

### Ambient Conditions

The local ambient climatic conditions will determine the type and size of the ventilation system required in order to maintain acceptable house conditions for the birds (see section on *Ventilation* for more details).

### Heating

In most climates around the world, a heating system is required to keep the house at the desired set-point temperature in the colder months, especially during the rearing stages. Examples of different types of heating equipment are shown in **Figure 98**. The actual heating equipment required will depend on local climate, house design and local fuel availability.

**Figure 98:** Examples of different house heating systems (from left to right, canopy brooder, whole-house heating, and space heater).



The heating system should provide enough capacity to maintain the desired house temperature in the colder periods while allowing minimum ventilation requirements to be satisfied. Heat must be evenly distributed throughout the house and should be operated in combination with the main ventilation control system.

### Biosecurity

In designing the structure of the house:

- Use materials that provide easily cleanable surfaces.
- Smooth concrete floors are easier to wash and disinfect.
- Keep an area of concrete or gravel extending to a width of 1-3 m (3-10 ft) free of vegetation around the house as this will discourage entry of rodents.
- Make sure the house is proofed against entry by wild birds.

In designing the layout of the farm:

- Provide shower facilities for staff entering and leaving the farm.
- If vehicles are to enter the farm (which is not desirable), then a spray booth or equivalent should be available to disinfect the vehicle.
- Locate feed bins along the fence line so that feed trucks do not need to enter the farm.



- House design checklist:
  - ✓ Environmental control type (controlled/natural).
  - ✓ Egg requirements, bird numbers and stocking density.
  - ✓ Lighting and light proofing.
  - ✓ Insulation.
  - ✓ Heating.
  - ✓ Biosecurity.
  - ✓ Ventilation.

# Ventilation

## Objective

To ensure that good welfare and reproductive performance are achieved by maintaining birds under appropriate, and where possible, optimal environmental conditions.

## Principles

Ventilation is used to achieve an in-house environment that will optimize bird comfort, achieve the best biological performance, and maintain bird health and welfare. The ventilation system supplies adequate fresh air and also removes excess moisture, gases, and airborne by-products. It also contributes to temperature and humidity control in all ambient conditions, and provides a uniform draft-free environment at bird level. Monitoring bird behavior is an essential part of ensuring that the correct ventilation is being achieved. Changes in bird behavior may be related to changes in the environment, and ventilation should be adjusted in response to bird behavior.



### Other Useful Information Available

Ventilation How To: *Calibrate an In-House Fluid Filled Pressure Meter*

Ventilation How To: *Measure House Air Tightness*

Ventilation How To: *Measure Fan Capacity*

Ventilation How To: *Check Air Inlets are Open Correctly for Minimum Ventilation*

*Environmental Management in the Broiler Breeder Rearing House*

*Environmental Management in the Broiler Breeder Laying House*

## Air

The main contaminants of air within the house environment are dust, ammonia, carbon dioxide, carbon monoxide, and excess water vapor (**Table 21**). Levels of these contaminants must be kept within legal limits at all times. Continued and excessive exposure to these contaminants can:

- Damage the respiratory tract.
- Decrease the efficiency of respiration.
- Trigger disease (e.g. ascites or chronic respiratory disease).
- Affect temperature regulation.
- Contribute to poor litter quality.
- Reduce bird performance.

**Table 21:** Effects of common parent stock house air contaminants.

Ammonia	Ideal level <10 ppm. Can be detected by smell at 20 ppm or above. >10 ppm will damage lung surface. >20 ppm will increase susceptibility to respiratory diseases. >25 ppm may reduce growth rate depending upon temperature and age.
Carbon Dioxide	Ideal level <3,000 ppm. >3,500 ppm causes ascites. Carbon dioxide is fatal at high levels.
Carbon Monoxide	Ideal level <10 ppm. >50 ppm affects bird health. Carbon monoxide is fatal at high levels.
Dust	Damage to respiratory tract lining and increased susceptibility to disease. Dust levels within the house should be kept to a minimum.
Humidity	Ideal level 50-60% after brooding. Effects vary with temperature. At >29°C (84.2°F) and >70% relative humidity, growth will be affected. Relative humidity <50% particularly during brooding will affect growth.

## Housing and Ventilation Systems

There are two basic types of ventilation systems:

### Natural Ventilation

- Also known as open-sided, curtain-sided, or natural houses.
- Fans may be used inside the house to circulate and move air.

### Power Ventilation (controlled/closed environment housing)

- These houses usually have either solid sidewalls or curtains that are kept closed during house operation.
- Fans and inlets are used to ventilate the house.

### Open-Sided/Natural Ventilation

Open-sided (or naturally ventilated) houses rely on the free flow of air through the house for ventilation (**Figure 99**). Achieving adequate control of the in-house environment can be difficult in open-sided houses, and as a result, consistency and level of performance tends to be lower than in controlled-environment houses.

**Figure 99:** Example of typical open-sided housing.





Air flow in open-sided houses is controlled by varying curtain height. Curtains should be fastened to the side wall at the bottom and be opened from the top down as to minimize wind or drafts blowing directly on the birds.

Curtains should be opened on both sides of the building to provide cross ventilation. If there is light wind or the wind is changing directions, curtains on each side of the building should be opened the same amount. If winds are coming consistently from one side of the building, the curtain on the side of the prevailing wind should be opened less than the downwind side to minimize drafts on the birds. Recirculation fans can be used to supplement natural ventilation and enhance temperature control within the house.

Translucent curtain materials allow the use of natural light during daylight hours. Black curtains are used in situations where it is necessary to exclude daylight (e.g. to provide blackout during rearing).

Achieving adequate ventilation during hot weather can be difficult in open-sided houses. However, several steps can be taken to minimize the impact of hot weather. These include:

- Reducing flock stocking density.
- Insulating the roof to prevent radiant heat from the sun reaching the birds. In some instances water can be used to cool the roof. This strategy must be used with caution as runoff from the roof can lead to increases in relative humidity levels.
- Using circulation fans to create uniform air movement over the birds.
- Using tunnel ventilation system with evaporative cooling.

Naturally ventilated houses should be constructed to a specified width, i.e. 9-12 m (30-40 ft) and a minimum height to the eaves of 2.5 m (8 ft), to ensure adequate air flow.

When outside conditions are cold, opening the curtains even slightly results in the heavy cold air entering the house and dropping directly down onto the litter and the birds. This cold air causes the birds discomfort and can result in wet litter. At the same time, warmer air escapes from the house, which results in large temperature swings and high heating costs.

In cold weather, internally mounted circulation fans can be used to enhance temperature control within the house by circulating the warm air that has risen and accumulated in the peak of the house. However, care must be taken to ensure that these fans do not create any air movement at bird level. In cool climates, automatic curtain operation is recommended, with circulation fans also operated by timers with thermostat overrides.

During hot weather, unless there is a wind blowing, opening the curtains fully may still not provide adequate relief for the birds. Circulation fans can also help in this situation by creating air movement over the birds, giving them some relief through the wind-chill effect.

Circulation fans, if installed, normally hang down the center of the house (**Figure 100**), but installing hot weather circulation fans near to the sidewall of the house means the fans will draw cooler, fresh (less humid) air from outside the house. Fans are usually installed to blow air diagonally across the house and should not be installed too close to any solid surface that may restrict air flow.

**Figure 100:** Circulation fans in a naturally ventilated house.





**Controlled Environment Housing**

Power ventilation in controlled or closed environment houses is the most popular form of ventilation system for parent stock due to the ability to provide better control of the internal environment under a range of ambient conditions. The most common form of controlled environment housing is that which operates under a negative pressure. These houses usually have solid sidewalls and exhaust fans that draw air out of the house and automated inlets through which fresh air is drawn into the house (**Figure 101**).

**Figure 101:** Example of controlled-environment housing.



In order to provide the best environment for the bird throughout the production cycle and at any time of the year, every closed-environment house should be equipped to cater for the three stages of ventilation. These are:

- Minimum ventilation.
- Transitional ventilation.
- Tunnel ventilation.

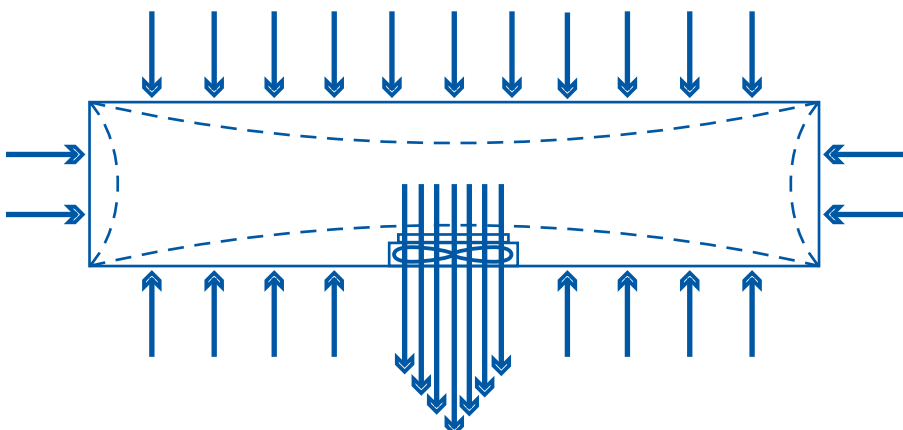
In some regions of the world where ambient temperatures do not get hot enough to warrant the need for tunnel ventilation, this stage may be omitted from the design of the house.

Because closed-environment houses usually have solid sidewalls, it is strongly advised to link these houses to standby generators in case of loss of power. In power-ventilated, curtain-sided houses, automatic curtain-opening devices should be in place.

Most modern controlled-environment housing uses negative-pressure ventilation. This means that fans exhaust air out of the house and fresh air is drawn into the house through air inlets. This is called negative-pressure ventilation because it works by creating a partial vacuum inside the house.

When a negative pressure is created (as in-house air is drawn out of the house), fresh outside air enters evenly through all inlets in the house (**Figure 102**). As the negative pressure increases, the speed of the air entering the house increases. In this way, pressure can be used to regulate the speed of the incoming air and how far the air will uniformly travel into the house before it turns and moves toward floor level.

**Figure 102:** Diagram illustrating air flow through air inlets in a negative-pressure system.

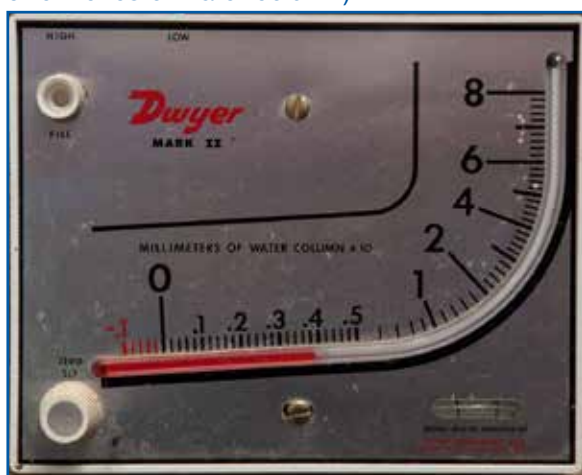


Negative pressure only works efficiently if the house is effectively sealed. In a house that is effectively sealed against air leaks, all the air entering the house comes in through the desired air inlets and uncontrolled air leakage will be minimized.

To determine how well sealed (or airtight) a house is, close all doors and inlets in the house and switch on one 122 cm (48 in)/127 cm (50 in) fan, or two 91 cm (36 in) fans. The pressure within the house should not measure less than 0.15 inches of water column (37.5 Pa). Pressure can be measured anywhere in the house and should be consistent throughout the house.

Air pressure within the house should be monitored regularly. Monitoring pressure over time is a useful means of identifying air leakage and there are easy-to-use pressure gauges (manometers) available (**Figure 103**). If the air pressure falls below the suggested levels (0.15 inches of water column or 37.5 Pa), an investigation should be carried out and appropriate action taken (e.g. repair broken inlets or ripped curtains).

**Figure 103:** A manometer used to monitor air pressure within the house (the reading given is equivalent to 0.15 inches of water column).



- For a negative-pressure system to operate successfully, the house must be air tight.
- Monitor pressure over time to identify the presence of any air leakage in to the house. If pressure drops below the desired levels, take immediate corrective action.

## Minimum Ventilation

Minimum ventilation brings fresh air into the house and exhausts any stale in-house air (to remove excess moisture and prevent the build-up of harmful gases), while maintaining the required in-house air temperature.

Some minimum amount of ventilation must be given at all times when there are birds present in the house – no matter what the outside temperature is. Minimum ventilation can be used during winter and summer and at any stage of the production cycle but is most commonly used during brooding and cool weather (i.e. whenever it is colder outside than the desired in-house set-point temperature and the actual house temperature is at or below the required set point temperature). Minimum ventilation is not adequate for cooling birds during high temperatures and should create very little air movement at bird level. Good ventilation is particularly important for young birds under 10 days of age.

During minimum ventilation, hanging strips of cassette or video recorder tape on feeders and drinkers can be a useful means of detecting the extent of air movement at bird level.

**Minimum Ventilation Layout**

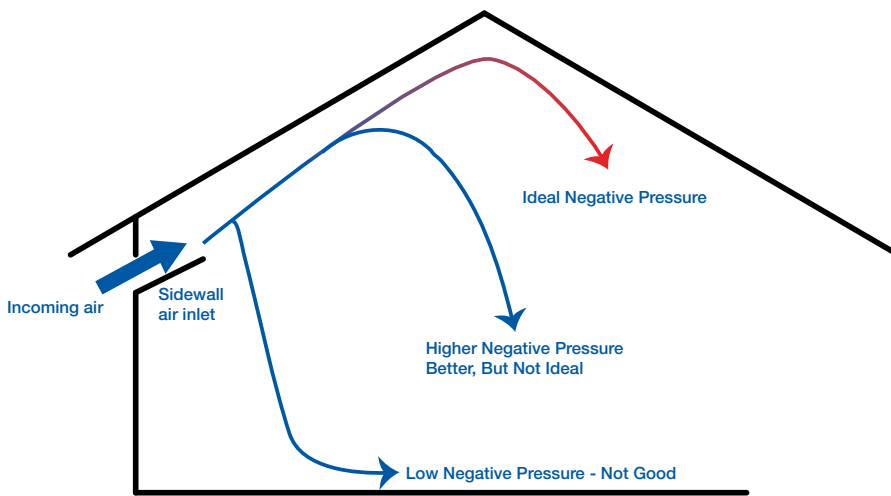
Currently the most common minimum ventilation system in use is known as cross ventilation. Cross ventilation consists of numerous sidewall inlets evenly spread along both sides of the house. The inlets are linked to a winch and open and close automatically as determined by the control system.

Minimum ventilation exhaust fans are often installed in the sidewall(s) of the house, or sometimes one or more of the tunnel fans are used, although this is not always ideal. The minimum ventilation fans operate on a cycle timer (ON/OFF), which is again determined by the control system.

**Using Negative Pressure During Minimum Ventilation**

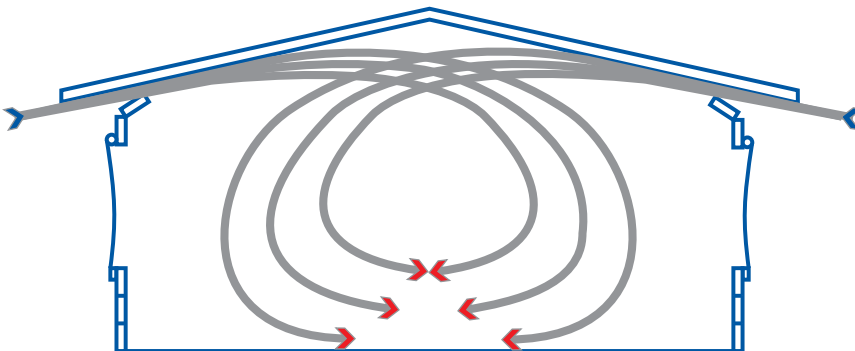
During minimum ventilation, the air inlets operate on the basis of negative pressure. By setting the air inlets properly and managing the negative pressure in the house, the speed at which outside air enters the house through the air inlets can be controlled. During minimum ventilation, negative pressure should be high enough to direct the cold incoming air at high speed away from the birds and up toward the apex of the house where the warm air accumulates. If negative pressure is too low, the cold air will simply drop onto the chicks, chilling them and creating wet litter (**Figure 104**).

**Figure 104:** Using negative pressure to control air speed.



A high air speed will also ensure good mixing of the cold incoming air with the warm in-house air that collects in the apex of the house (**Figure 105**), making the incoming air warmer and reducing its relative humidity allowing it to absorb moisture.

**Figure 105:** Correct air flow during minimum ventilation.



### What is the Correct Operating Pressure for a House?

The negative pressure (and incoming air speed) should be enough to throw the incoming air to the middle of the house. The ideal operating negative pressure of a house during minimum ventilation will depend on the following factors:

- The width of the house (the distance the air must travel from the side wall to the peak of the roof).
- The angle of the internal ceiling.
- The shape of the internal ceiling (smooth or with obstructions).
- The type of inlet used.
- The amount the inlet is opened.

Guidelines exist for the operating pressure of different-width houses, but these will vary based on the factors given above. Correct operating pressure for individual houses should be tested, checked, and confirmed. One way to do this is by completing a smoke test (**Figure 106**).

**Figure 106:** Using a smoke test to determine if air flow and operating pressure is correct.



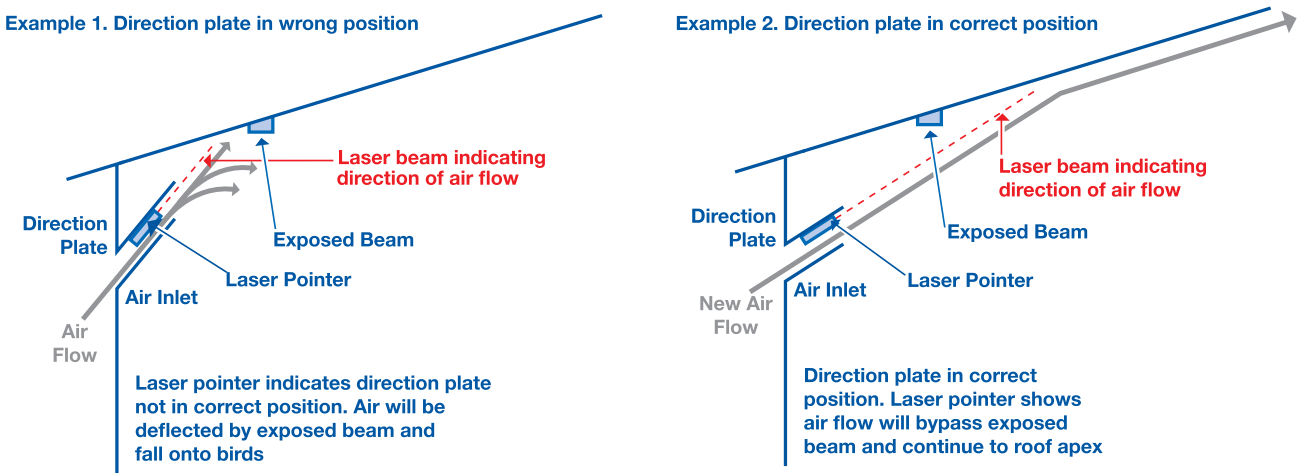
When smoke testing a house, it is advisable to do it under worst-case conditions, that is, when the house is at brooding temperature and when the ambient temperature is at, or close to, as cold as it may get. As long as all air inlets are opened an equal amount the smoke test can be completed on any inlet. Hold the smoke bomb approximately 5-10 cm (2-4 in) below or away from the inlet or curtain opening to allow a sufficient volume of smoke to be emitted so direction of flow can be seen clearly.

Be aware that some smoke generators emit warm smoke. If testing a house when it is empty and cold inside, the smoke will try to rise to the peak of the house even if the pressure is actually too low.

Alternatively, strips of cassette or video tape about 15 cm (6 in) long can be hung from the ceiling every 1-1.5 m (3-5 ft). These should be positioned in front of an air inlet near the entrance to the house and up to the apex of the house. When the fans are on, every strip of tape should move, including the one closest to the roof apex. The tape closest to the inlet should show significant movement, and will blow strongly against the roof. Movement of the tapes should get less the closer the tape is to the roof apex. The last tape (in the apex of the roof) should only move gently showing that the air has just made it to the middle of the house and has stopped and started to move downward. These tapes can remain in place throughout the production cycle and provide a quick visual check when entering the house.

If the roof has exposed beams, frames or any other structural obstruction crossing the path of the air flow, direction plates will need to be fitted to the air inlets. These will direct the incoming air below the obstruction but still to the apex of the roof. The direction plates must be carefully and correctly set. A presentation-type laser pointer with a strong red or green-colored laser beam can be used to help determine if the direction plate is set correctly. Holding the pointer on the air direction plate and seeing where the laser dot hits the roof surface, can give a good indication of the angle at which the direction plate should be set in order to avoid the obstructions (**Figure 107**).

**Figure 107:** Using a presentation laser to determine if the air direction plate is positioned correctly. A simple laser pointer can be used to provide a visual reference of direction of air flow into the house. The direction plate can then be set to ensure that air flow bypasses any ceiling obstructions.



**Setting Air Inlets**

When setting the inlets for minimum ventilation, they should be open at least 5 cm (2 in) for the air flow into the house to be effective (**Figure 108**). If the air inlets are not opened enough, the incoming air will travel only a short distance into the house before falling to the birds, regardless of the house pressure. The greater the inlets are open, the greater the volume and speed of air entering the house. However, in most houses, if all the sidewall inlets are opened to 5 cm (2 in) during minimum ventilation, negative pressure within the house will be too low and the speed at which the air enters the house will be reduced, increasing the risk of it falling directly onto the birds. Generally, for minimum ventilation, not all the available air inlets will need to be opened. The inlets that are used must be evenly spaced around the house and all must be opened equally.

The ability to walk anywhere in the house while the minimum ventilation cycle timer fans are running and not feel air movement is a good indication that the house is adequately sealed and the inlets correctly set up for minimum ventilation. Accurate settings for the house can be determined by carrying out a smoke test or by using the cassette tape method (see section on *What is the Correct Operating Pressure*).

**Figure 108:** Illustration of air flow into the house. The picture on the left shows a correct fast air flow during minimum ventilation. The picture on the right shows an incorrect slow air flow during minimum ventilation.





**Choosing minimum ventilation inlets**

Some important characteristics to look for in an inlet (**Figure 109**) are:

- It should seal well when closed.
- The inlet door should be insulated.
- It should have a mechanism to lock/keep the door closed when not required to open.
- It should have an air direction plate to direct the incoming air, especially if the ceiling of the house has exposed obstructions.
- The inlet door should be set into the frame of the inlet and be inclined at an angle when in the closed position.

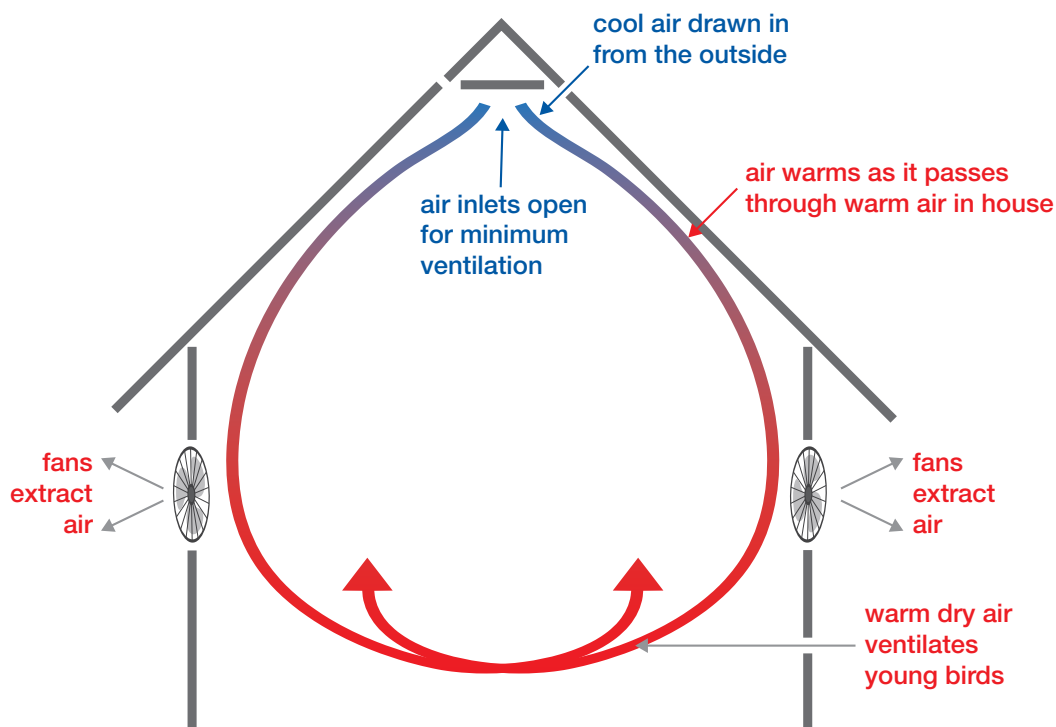
**Figure 109:** Example of a good-quality air inlet.



**Reverse-flow ventilation systems**

Reverse-flow ventilation systems have the inlet openings in the apex of the roof and the fans in the side wall of the house. Although less commonly seen than cross ventilation or roof extraction ventilation systems, they are still an effective ventilation system if managed correctly. Air is drawn in through the inlets in the apex of the roof and along the inner ceiling, warming up as it does so to provide dry warm air for ventilating the birds during minimum ventilation. For older birds and warmer environments, the roof inlets can be opened more to allow fresh air to be pulled directly onto the birds at a higher speed and without warming before it ventilates the birds. This type of system may also be used in combination with a tunnel-type system. The size of inlet opening for minimum ventilation is the same as with cross- or conventional-flow systems.

**Figure 110:** Diagram of reverse flow (roof inlet) ventilation.



**Minimum Ventilation Rates**

Minimum ventilation requirements are shown in **Table 22** below. Fully-worked calculations can be found in **Appendix 6**.

Prior to 7 days, the actual air speed at floor level should be no more than 0.15 m/sec (30 ft/min).

**Ventilation rates (per bird) for temperatures between -1 and 16°C (30 and 61°F)**

Maximum levels of RH, carbon monoxide, carbon dioxide, and ammonia should never be exceeded. Monitor bird behavior and distribution as this can be an indicator of issues that need to be investigated.

**Table 22:** Approximate minimum ventilation rates per bird.

Average Weight kg (lb)	Ventilation Rate m <sup>3</sup> /hr (ft <sup>3</sup> /min)
0.05 (0.11)	0.09 (0.05)
0.10 (0.22)	0.15 (0.09)
0.20 (0.44)	0.26 (0.15)
0.30 (0.66)	0.35 (0.21)
0.40 (0.88)	0.43 (0.26)
0.50 (1.10)	0.51 (0.30)
0.60 (1.32)	0.59 (0.35)
0.70 (1.54)	0.66 (0.39)
0.80 (1.76)	0.73 (0.43)
0.90 (1.99)	0.80 (0.47)
1.00 (2.21)	0.86 (0.51)
1.20 (2.65)	0.99 (0.58)
1.40 (3.09)	1.11 (0.65)
1.60 (3.53)	1.23 (0.72)
1.80 (3.97)	1.34 (0.79)
2.00 (4.41)	1.45 (0.86)
2.20 (4.85)	1.56 (0.92)
2.40 (5.29)	1.67 (0.98)
2.60 (5.73)	1.77 (1.04)
2.80 (6.17)	1.87 (1.10)
3.00 (6.62)	1.97 (1.16)
3.20 (7.06)	2.07 (1.22)
3.40 (7.50)	2.16 (1.27)
3.60 (7.94)	2.26 (1.33)
3.80 (8.38)	2.35 (1.39)
4.00 (8.82)	2.44 (1.44)
4.20 (9.26)	2.53 (1.49)
4.40 (9.70)	2.62 (1.55)
4.60 (10.14)	2.71 (1.60)
4.80 (10.58)	2.80 (1.65)
5.00 (11.03)	2.89 (1.70)

NOTE: This table should only be used as a guideline as actual rates may need to be adjusted to environmental conditions, bird behavior and bird biomass (total bird weight in the house).



**Calculating minimum ventilation requirement**

**Step 1:** Determine the average body weight of birds in the house.

**Step 2:** Select the appropriate ventilation rate for average body weight in the house (**Table 22**).

**Step 3:** Calculate the minimum ventilation requirement.

$$\text{Minimum ventilation requirement (m}^3\text{/hr or ft}^3\text{/min)} = \text{Number of birds in the house} \times \text{Appropriate minimum ventilation requirement}$$

**Minimum Ventilation Operation**

Minimum ventilation is regulated by a timer. The fans operate on a cycle timer, not according to temperature.

Correct management of the cycle timer settings determines the air quality in the house.

When the fans run, the sidewall minimum ventilation inlets should open the correct amount to maintain the correct negative pressure and direct the incoming air up to the peak of the roof. At the end of the ON time, the minimum ventilation fans will switch off and the inlets should close.

During minimum ventilation, the heating system should operate any time that the actual house temperature is below the required set point temperature, even if the minimum ventilation fans are running.

During the early stages of the production cycle, the heating set point is usually set to activate the heaters in close range to the required house set-point temperature. For example, the heaters may be set to activate at 0.5°C (1°F) below the house set-point temperature and switch back off again at the house set-point temperature or slightly above.

Because there is often more emphasis on adding heat to the house during minimum ventilation and the early stages of the cycle, the fans may be set to only start working continuously if the house temperature exceeds the set point by 1-1.5°C (2-3°F).

These settings will change as the birds grow older. Typically, the differential between the house set-point temperature and the heating set point will increase, and the differential between the house set-point temperature and the fan override temperature will decrease.

Calculating cycle timer settings:

**Step 1:** Calculate the minimum ventilation requirement (m<sup>3</sup>/hr or ft<sup>3</sup>/min).

**Step 2:** Calculate the percentage time the fans need to be running.

$$\text{Percentage of time} = \text{minimum ventilation requirement} \div \text{total capacity of fans being used}$$

Further details on calculation of fan cycle times can be found in **Appendix 6**.

**Evaluating Minimum Ventilation**

**Table 22** gives minimum ventilation rates (per bird) for increasing live weight. The figures given are a guideline only. Their use does not guarantee acceptable air quality or bird comfort. The best way to evaluate a minimum ventilation rate/setting is by visually assessing bird comfort and behavior.

When entering the house to evaluate the minimum ventilation rate, try to do so without disturbing the birds. Upon entering the house the following should be observed:

**Spread/distribution of the birds:**

- Are they well spread?
- Are there specific areas of the house that are being avoided?

**Bird activity:**

- Look along the feeder and drinker lines – is there bird activity at them?
- Birds should be feeding, drinking, and resting. During lay, there should be mating activity and birds using nest boxes.

**Air quality:**

During the first 30 to 60 seconds of entering the house, ask the following questions:

1. Does it feel stuffy?
2. Is the air quality acceptable?
3. Is humidity too high?
4. Does it feel too cool in the house?

The use of instruments capable of measuring relative humidity, carbon dioxide, carbon monoxide, and ammonia will allow a proper and quantitative evaluation. For specific air quality recommendations, see **Table 21**.

If any of the observations made indicate that minimum ventilation is not adequate, adjustments must be made to correct this.



- It is essential to provide some ventilation to the house regardless of the outside conditions.
- Minimum ventilation is used for young chicks, night time, or cold weather ventilation.
- Minimum ventilation should be timer driven.
- Achieving the correct operating negative pressure to ensure incoming air is drawn at high speed towards the apex of the roof is critical.
- Air inlet number and size of opening should achieve high air velocity to prevent cold air dropping to the floor.
- Not all air inlets may need to be opened but those that are opened should be evenly spaced and open the same amount.
- When setting up the minimum ventilation inlets, the minimum air inlet opening size should be around 5 cm (2 in).
- Monitor air flow and bird behavior to determine if settings are correct.

## Transitional Ventilation

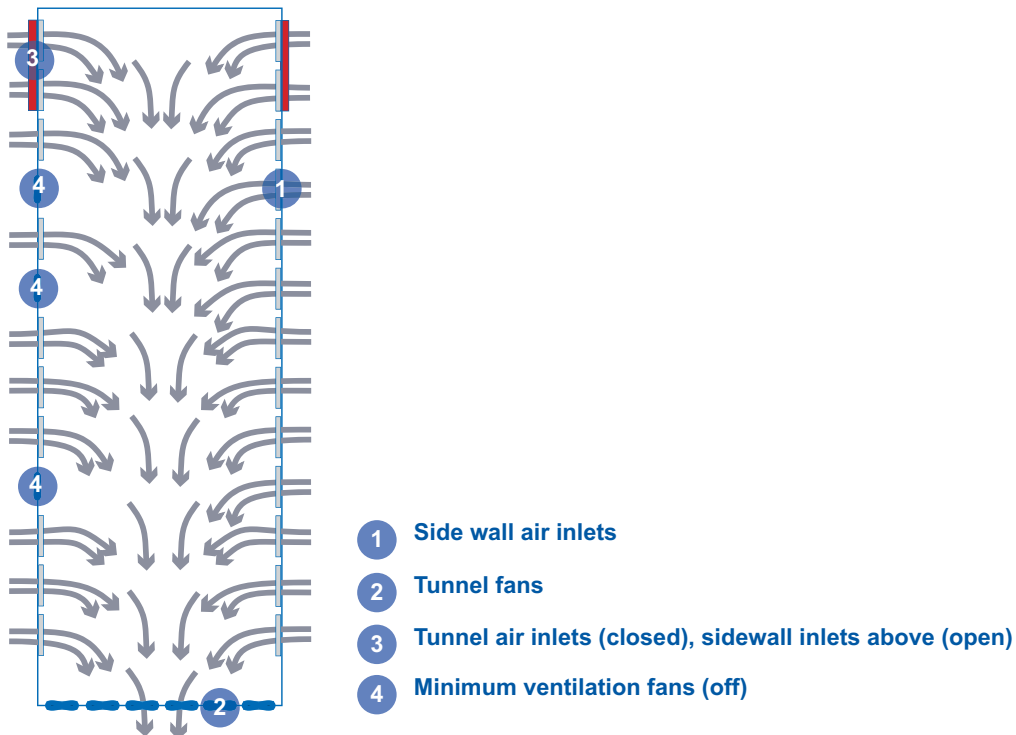
Transitional ventilation is used when the house temperature is above the desired (or set-point) temperature, but it is not yet warm enough (or the birds are still not old enough) to use tunnel ventilation (see section on *Tunnel Ventilation*). Transitional ventilation is a temperature driven process. As the house temperature increases above the required set point, the ventilation system should be set to stop operating minimum ventilation (cycle timer), and start to ventilate continuously for temperature control (transitional ventilation). During transitional ventilation, a large volume of air can be introduced into the house, but unlike tunnel ventilation, this air is not blown directly onto the birds.

Transitional ventilation works in a similar way to minimum ventilation. Air inlets operating on the basis of negative pressure direct the incoming air, at speed, away from the birds up to the apex of the house where it mixes with warm in-house air before falling back to floor level. The number of sidewall inlets in use is increased to allow a higher volume of air to be brought into the house. The total sidewall inlet capacity (number and size of inlets) determines the amount of air that can enter the house and in turn, the maximum number of fans that can be used.

If there are too few inlets in the house, it may be necessary to switch to tunnel ventilation earlier than normal to ensure excess heat is removed from the house. However, switching to tunnel ventilation can cause discomfort to the birds as air will be blowing directly onto them. As a general guideline for transitional ventilation, enough air inlets should be open so that approximately 40-50% of the tunnel fan capacity is being used.

During transitional ventilation, if the temperature continues to increase above the set-point temperature, more fan capacity will be required and after all the sidewall fans are operating continuously, the tunnel fans will also start to operate. The tunnel ventilation inlets remain closed; air only enters through the sidewall inlets during transitional ventilation (**Figure 111**).

**Figure 111:** Typical air movement during transitional ventilation.



During transitional ventilation, because large volumes of air may flow into the house for extended periods of time, birds may feel some air movement. Observing bird behavior (the distribution of birds in the house and bird activity) will help to determine if transitional ventilation settings are correct. If birds are seen sitting down or huddling and there is little activity at the feeders and drinkers, birds may be cold and corrective action should be taken. First check that the house pressure is correct. If it is, switch off the last fan that came on and continue to observe bird behavior. If bird activity improves, continue to monitor the birds for the next 15-20 minutes to be sure there are no further changes in behavior.

The house should be kept in transitional ventilation for as long as possible before switching to tunnel ventilation. The decision when it is necessary to switch to tunnel ventilation should be based on bird behavior (see section on *Bird Behavior in Tunnel Ventilation*).



- Transitional ventilation is used when a higher than minimum air exchange is required.
- Transitional ventilation is a temperature-driven process that removes heat when house temperature increases above the desired set point.
- Transitional ventilation is used when the outside air is too cold and/or birds are too young for tunnel ventilation to be implemented.
- Evaluating bird behavior is the only real way to determine if transitional ventilation settings are correct.

## Tunnel Ventilation

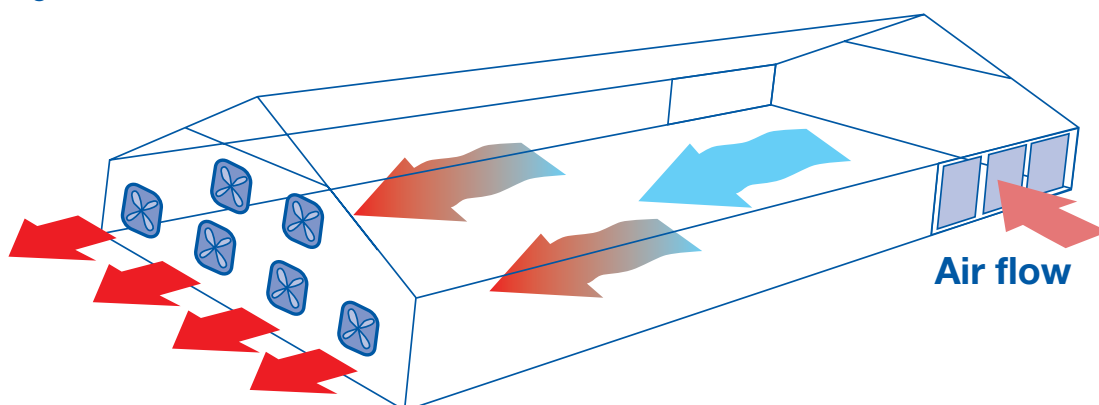
Tunnel ventilation is used to keep the birds feeling cool. **Figure 112** shows a typical tunnel-ventilated house.

**Figure 112:** Example of a typical tunnel-ventilated house.



The system uses fans (usually 122 cm [48 in] or 127 cm [50 in]) at one end of the house and air inlets at the other end. High volumes of air are drawn down the length of the house, exchanging the air in the house in a short time (**Figure 113**).

**Figure 113:** Air flow in a tunnel ventilated house.



The switch from transitional ventilation to tunnel ventilation should occur when the birds need the cooling effect of wind chill. The heat generated by the birds is removed and a wind-chill effect is created that allows the birds to feel a temperature that is lower than that shown on the thermometer or temperature probe/sensor. For any given wind speed, younger birds that are not fully feathered will feel a greater wind chill than older birds and so are more prone to wind-chill effects. After 7 weeks of age, birds are expected to be fully feathered and the effects of wind chill are less.

When using tunnel ventilation for cooling, birds will tend to move (migrate) towards the cooler, inlet end of the house, resulting in crowding. If the breeder house is not routinely divided into pens (which will prevent migration), the addition of migration partitions should be considered.

### Wind-chill Effect

Wind chill is the cooling effect felt by the birds during tunnel ventilation due to air flow. The actual cooling effect that the birds feel is the result of the combination of a number of factors:

- The age of the bird – the younger the bird the greater the cooling effect.
- The air speed – the higher the air speed the greater the cooling effect.
- The air temperature (dry bulb temperature) – the higher the temperature the more cooling required.
- Relative humidity (RH) – the higher the RH the lower the cooling effect.
- Stocking density – the higher the stocking density the lower the cooling effect.

The actual temperature felt by the birds during tunnel ventilation is known as the effective temperature. Effective temperature cannot be measured by a thermometer or temperature probe/sensor. As such, during tunnel ventilation, the readings taken by the thermometer or temperature probe are limited in determining the temperature that the bird may be feeling.

### Bird Behavior in Tunnel Ventilation

Monitoring and evaluating bird behavior are the only real ways to determine if tunnel ventilation settings are correct for the age, stocking density, biomass and feather cover of the flock. The effects of wind chill on a flock cannot be clearly defined by using temperature and humidity meters only. During tunnel ventilation, regardless of what the house thermometer is showing, birds could be feeling much cooler or hotter than house sensors indicate they should. Use extreme caution when using tunnel ventilation with younger birds as wind-chill effect will be much higher.

If birds are sitting down and huddling, they may be feeling cold. If birds are spread out, but with wings held slightly away from their bodies, or if they are lying on one side with one wing open, they may be too warm. If more than 10% of birds are panting slightly or heavily, the flock may be too warm.

During lay, drops in egg production may be due to extremes in temperature from incorrect tunnel ventilation management. If birds are too cool for example, energy will be used to keep warm rather than for egg production. If birds are too warm, feed intake will reduce and more energy will be expended for increased respiration and egg production will drop. Floor eggs may increase if air speed is too high causing drafts in nest boxes, as birds will prefer to lay eggs on the floor where the air speed is usually slower.

Tunnel ventilation settings should be checked and adjusted if birds are exhibiting any of the above behaviors.

This can be done by:

- Reducing or increasing the number of fans in use.
- Turning on or off evaporative cooling systems (fogging or pads).
- Increasing air speed by the use of in-house baffles to increase wind-chill effect.
- Increasing or reducing the amount of time that evaporative cooling pad pumps are running.



- Tunnel ventilation cools birds through high-velocity air flow.
- Tunnel ventilation controls the effective temperature felt by the bird which can only be estimated by bird behavior.
- If the house design permits tunnel ventilation only, then considerable caution should be practiced with young birds that are not fully feathered.
- Younger birds feel a greater wind chill than older birds for a given air speed, and thus are prone to wind-chill effects.
- Observations of bird behavior are critical.

### Tunnel Ventilation Calculations

The steps to determine the number of fans required for tunnel ventilation are given below. A fully worked example calculation can be found in **Appendix 6**.

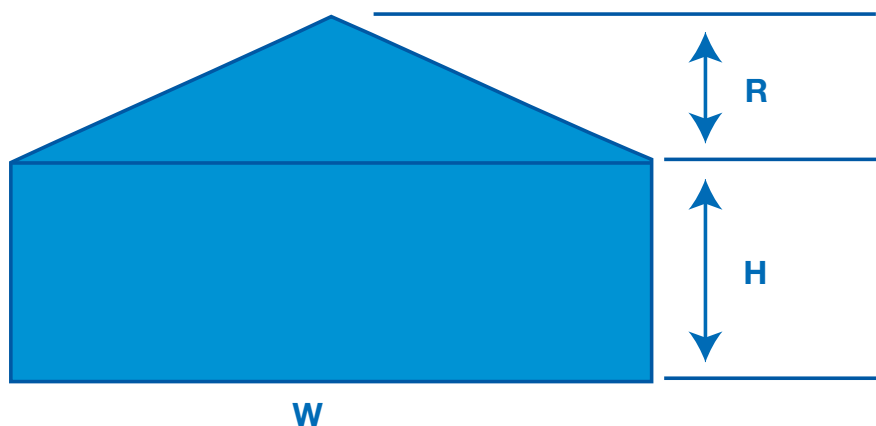
**Step 1:** Determine the fan capacity required for a given air speed.

**Required fan capacity = design air speed x cross section area**

Where:

- Design air speed (minimum):
  - » 2.03 meters per second (m/s) or 400 feet per minute (fpm) for rearing.
  - » 2.54 meters per second (m/s) or 500 feet per minute (fpm) for production.
- Cross section area =  $(0.5 \times W \times R) + (W \times H)$  (see **Figure 114**).
- Cross section area is the effective area through which the air flows down the length of the house. If there are other major obstructions such as nests in the house, then the area of these obstructions can be subtracted from the total cross section area.

**Figure 114:** Elevation of house showing height (H), width (W), roof (R) for calculating cross section area for tunnel ventilation calculations.



**Step 2:** Determine the number of fans required.

**Number of fans = required fan capacity ÷ fan operating capacity**

Where:

- As a guideline for tunnel ventilation with cooling pads, use the fan capacity at an operating pressure of 37.5 Pa (0.15 inches water column).
- Fan operating capacity is the capacity at the assumed operating pressure.

## Evaporative Cooling Systems

### What Is Evaporative Cooling?

Evaporative cooling is the cooling of air through the evaporation of water. It improves environmental conditions in hot weather and enhances tunnel ventilation. Evaporative cooling should only be used when the birds' behavior indicates that the wind-chill effect on its own is no longer keeping the birds comfortable. Evaporative cooling keeps the temperature of the house at the level where the birds were last comfortable with all the fans operating. The purpose of evaporative cooling is not to reduce the house temperature back down to (or even close to) the set-point temperature of the house.

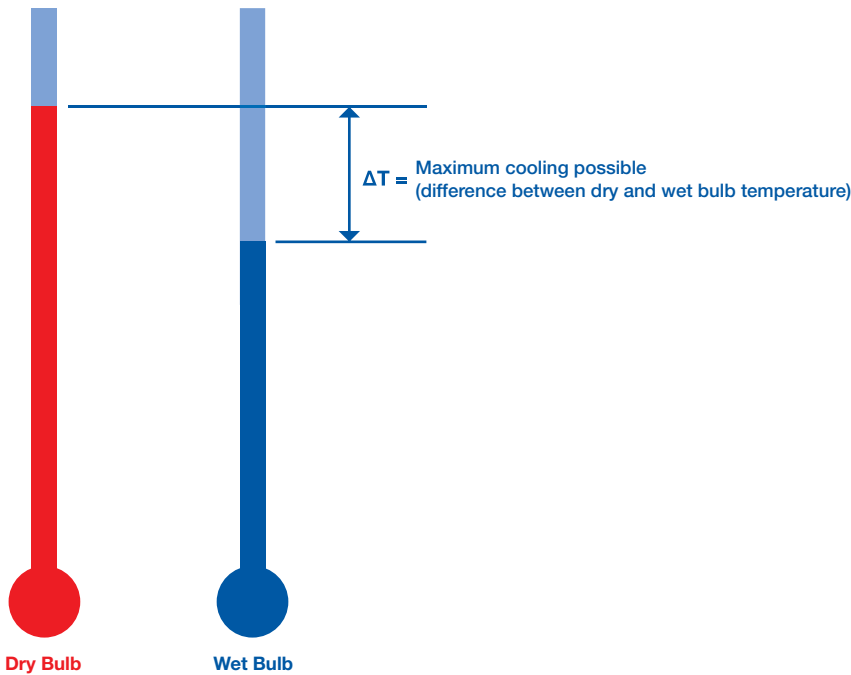
The amount of evaporative cooling that can take place depends on the relative humidity (RH) of the ambient external environment.

- The lower the RH of the air, the greater the amount of moisture that it can accept and so the greater the amount of evaporative cooling that can take place.
- The higher the RH is, the less the evaporative cooling potential of the air.



At any given time, the difference between dry bulb (the actual air temperature) and wet bulb (temperature when air is 100% saturated) temperatures will give an indication of the maximum evaporative cooling that could take place assuming that evaporative cooling is 100% efficient (**Figure 115**). In reality, the actual temperature reduction able to be achieved will be closer to 65-75% of the difference between dry and wet bulb temperatures.

**Figure 115:** Maximum cooling possible during evaporative cooling is about 75% of the difference between dry and wet bulb temperature. For example, a temperature difference of 4°C (7°F) will result in 3°C (5°F) of cooling.



There are two main types of evaporative cooling - pad cooling and spray cooling.

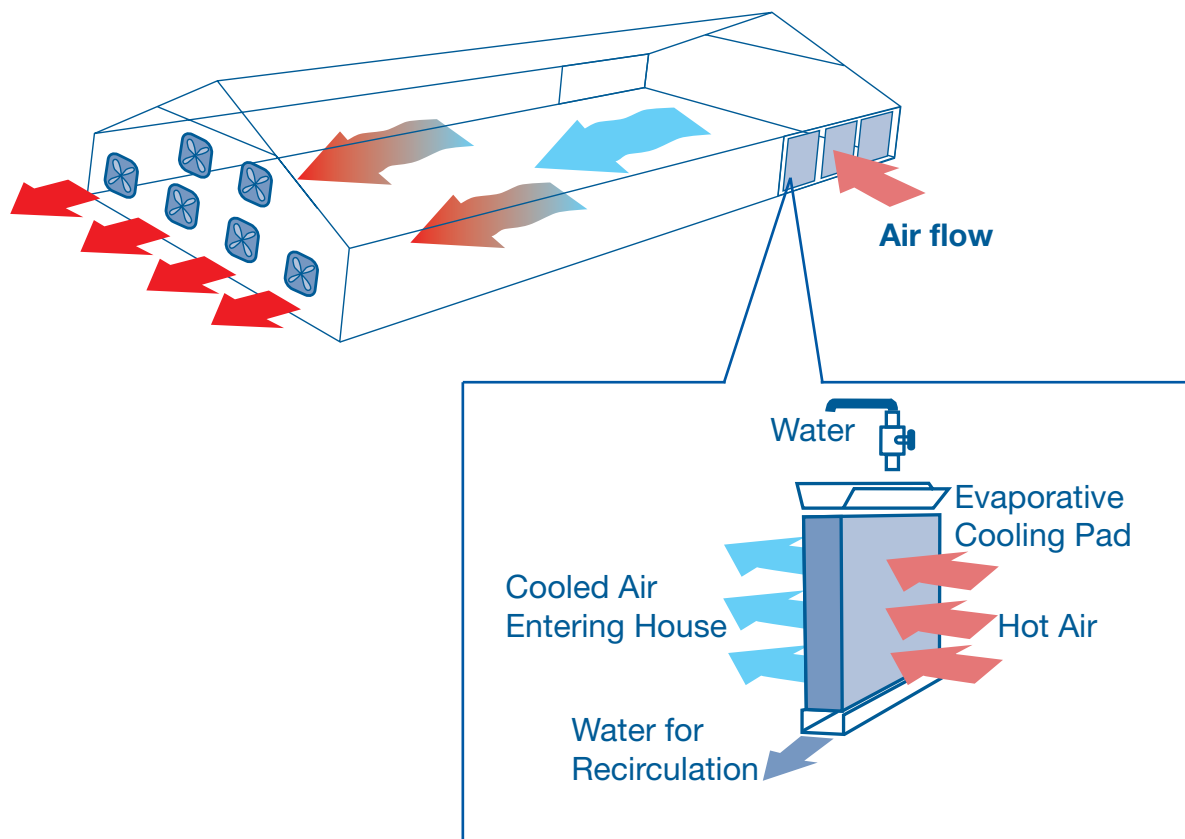
**Pad Cooling**

In pad cooling systems, cool air is drawn through a water-soaked filter (cooling pad) by the tunnel ventilation fans (**Figure 116** and **Figure 117**). This design and layout of the cooling pads allows the large volumes of air used in tunnel ventilation to enter through the pad surface area and be cooled before entering the house.

**Figure 116:** Example of a cooling pad.



Figure 117: Pad cooling with tunnel ventilation.



Calculation of cooling pad area (a full worked example calculation is given in **Appendix 6**):

**Cooling pad area = tunnel fan capacity ÷ pad air speed**

Where:

- Cooling pad area is the total area required. Half of this area is usually installed on each outside wall at the inlet end of the house.
- Tunnel fan capacity is the actual total operating capacity.
- Pad air speed refers to the speed of the air traveling through the pad. As a guideline:
  - « For 100 mm (4 in) thick pad, use 1.27 m/s (250 fpm)
  - « For 150 mm (6 in) thick pad, use 1.91 m/s (375 fpm)

Because evaporative cooling adds moisture to the air and increases relative humidity, it is recommended that evaporative cooling be switched off when the relative humidity in the house exceeds 70-80% (see information on page 132).

**Operating cooling pads**

The use of cooling pads must be managed correctly to ensure birds do not become chilled. The degree of cooling that can be achieved with pad cooling will depend upon the ambient relative humidity in the environment.

During evaporative cooling, water is pumped onto the cooling pads by cooling pumps. When the cooling pumps first start operating, care must be taken to control the amount of water added onto the cooling pads. Too much water on the pads initially will cause the house temperature to reduce rapidly. This temperature reduction in turn will cause fans to switch off (if automated), changing the wind-chill effect on the birds and the environmental conditions from one end of the house to the other. Ultimately, this change affects bird comfort and health.

The best control over the management of cooling pads can be achieved by cycling the cooling pump on and off, which will limit the amount of water going onto the pads initially and allow better control of the temperature. If the house temperature continues to increase, then the controller should be set to automatically increase the ON period of the pump cycle to put more water onto the pad, thus trying to maintain the required temperature rather than create a large reduction in the house temperature.

The cooling pump should not operate continuously until the house temperature dictates that it should switch off again. If the pump does operate continuously, a large portion of the pad will be wet by the time the cooling pump switches off, and the temperature will continue to decrease until the pad becomes dry. Operating the cooling pumps in this way can cause house temperature to fluctuate by 4-6°C (7-11°F) and sometimes more.

Water quality can have a significant effect on cool pad functionality. Hard water containing high concentrations of calcium can reduce the operating life of the cool pad.

### Fogging/Misting

Fogging systems cool incoming air by evaporation of water created by pumping water through spray/fogger nozzles (**Figure 118**). Fogging lines must be placed near the air inlets to maximize the speed of evaporation and additional lines should be added throughout the house.

**Figure 118:** Example fogging system for a cross-ventilated house.



There are three types of fogging systems:

- Low pressure, 7-14 bar; droplet size up to 30 microns.
- High pressure, 28-41 bar; droplet size 10-15 microns.
- Ultra high pressure (misting), 48-69 bar; droplet size 5 microns.

A low-pressure system provides the least amount of cooling, and due to the larger droplet size, there is a greater chance of the droplets not evaporating and causing wet litter. These systems are not recommended for use in areas of high relative humidity.

The ultra-high pressure system will create the most cooling and has the lowest risk of wetting the litter.

The number of nozzles and total amount of water introduced should be based on the maximum tunnel fan capacity.

### Relative Humidity, Birds, and Evaporative Cooling

- Evaporative cooling is more effective in an environment with low relative humidity (RH).
- When birds pant, they use evaporative cooling to help them release heat and lower their body temperature.
- When an evaporative cooling system (pads and spray/foggers) operates, water evaporates into the environment, increasing the RH of the air.

If an evaporative cooling system is operating at its maximum potential with all the tunnel fans operating, but still the birds are panting, then relative humidity in the house may be high.

An evaporative cooling system should always operate based on a combination of temperature and RH, and never based purely on temperature and/or time of day.

Trying to use evaporative cooling without sufficient air speed should be avoided, particularly with older birds. Though the evaporative cooling system will reduce the air temperature, it also increases the relative humidity of the air. This increase in relative humidity restricts the birds' ability to lose heat through panting.

However, combining the evaporative cooling with high air speed over the birds increases the amount of heat that the bird is able to lose to the environment around it and reduces its need to lose heat through panting.

In recent years, the recommendation was to avoid using evaporative cooling when the house RH was higher than 70-75% to enable the bird to lose more heat through panting. Recent research has suggested that the bird is capable of tolerating a higher RH provided that there is sufficient air speed to help it lose heat from its body to the air around it.

In hot, humid climates when the natural RH approaches saturation in the afternoon/evening, high air speed through the house and a fast air exchange rate plays a crucial role in keeping birds alive. In these conditions, it is vital that the house has been correctly designed (correct number of fans and correct size of tunnel inlet opening and cool pad).



- Evaporative cooling is used to enhance tunnel ventilation in hot weather.
- There are two types of systems - pad cooling and fogging/misting.
- Keep fans, foggers, evaporators, and inlets clean.
- Evaporative cooling adds moisture to the air and increases RH. It is important to operate the system based on RH as well as dry bulb temperature to ensure bird welfare.
- Monitor bird behavior to ensure bird comfort is maintained.

## Light Baffles

The use of light baffles in broiler breeder facilities is common place, particularly during the rearing period when a controlled short daylength of 8-9 hours is essential.

The use of light baffles on fans and inlets (**Figure 119**) will reduce ventilation capacities and should be taken into consideration when ventilation systems are being designed.

**Figure 119:** Example of a light baffle fitted to a cross ventilation inlet.



# Lighting

## Objective

To achieve optimal reproductive performance through appropriate illumination (daylength and light intensity) and photostimulation (increase in daylength) at the correct age and body weight.

## Principles

All broiler breeders are hatched photorefractorily. This means that they are unable to respond positively to a stimulatory (long or  $\geq 11$  hours) daylength. The ability to respond to a stimulatory daylength depends upon birds being exposed first to a period of neutral or short days (8 hours), at least 18 weeks for typically grown broiler breeders. Long daylengths ( $\geq 11$  hours) during the rearing period should be avoided as they will delay sexual development, reduce egg numbers, and increase egg weight.

After prolonged exposure to long daylengths, birds become adult photorefractory. This means they are no longer responsive to a long stimulatory daylength, and production begins to decline.

Lighting for broiler breeders aims to dissipate juvenile photorefractoriness, and ensure that all birds are photosensitive and can positively respond to stimulatory daylengths in ways that optimize lay. Where applicable, local legislation should be followed.



### Other Useful Information Available

Aviagen Booklet: *Lighting for Broiler Breeders*

## Lighting During Brooding

Regardless of housing type, for the first 2 days after placement birds should be given 23 hours of light and 1 hour of dark a day. This light schedule will help appetite development and promote feeding activity. Where closed (controlled-environment) housing is used during rear, daylength should be gradually reduced to 8 hours by 10 days of age.

Light intensity in the brooding area during the first few days should be bright (80-100 lux [7-9 fc]) to ensure that the birds find feed and water, but from 6 days of age this should be reduced to between 30 and 60 lux (3-6 fc) in controlled-environment housing and 60-80 lux (6-7 fc) in open-sided housing.

## Lighting Programs and Housing Type

Different types of housing in the rearing and/or laying periods mean that there are three common combinations of lighting environment:

1. Closed rearing house (controlled environment) and closed laying house (controlled environment).
2. Closed (controlled environment) or blackout rearing house and open-sided (natural environment) laying house.
3. Open-sided rearing house (natural environment) and open-sided laying house (natural environment).

The recommended lighting programs for each of these three environments are given in the next sections. All lighting programs will achieve 5% production at 25 weeks of age. If the target for production is different than 5% at 25 weeks, then the age at which first light increase is given should be altered accordingly. Typically, it will take between 14 and 21 days from photostimulation to 5% egg production, with lighter birds taking longer to start laying eggs than heavier ones.

### Lighting Programs for Controlled-Environment Rearing and Controlled-Environment Laying

Controlled-environment housing during rear permits greater control over daylength. The ability to control daylength so that birds receive a constant short daylength from 10 days of age resolves many production problems (for example, delayed sexual maturity, high female body weight, poor flock uniformity, and high feed consumption), and gives better control of undesirable behaviors. The proportion of abnormal eggs and the risks of prolapse, broodiness and egg peritonitis, and other conditions reducing welfare and performance can be minimized by ensuring that:

- Birds are at target body weight for their age.
- Birds have good body-weight uniformity.
- The lighting programs shown in **Table 23** are followed.

Achieving satisfactory production from birds kept in controlled-environment housing (**Figure 120**) depends on the adequacy of the light proofing. In dark periods, light intensity should not exceed 0.4 lux (0.04 fc). Measures should be taken to avoid light leakage through air inlets, fan housings, door frames, etc., and regular checks should be made to verify the effectiveness of the light proofing.

**Figure 120:** A typical controlled-environment house with full lighting control that can control the light intensity to a maximum 0.4 lux (0.04 fc) in the dark period.



Light proofing is especially important during rear, when the birds need to experience a period of short days (8 hours) before they can become responsive to the pre-lay increase in daylength.

**Table 23** details the recommended lighting program for birds kept in controlled environment housing. In rear, a constant daylength of 8 hours is achieved by 10 days of age and maintained until photostimulation (transfer to a stimulatory daylength).

To achieve the recommended 5% production at 25 weeks of age, photostimulation should not occur before 147 days (21 weeks). The actual age at which daylength is increased from short (8 hours) to long ( $\geq 11$  hours) days depends on the average flock body weight and flock uniformity. Regular assessment of body weight, uniformity and pin bone spacing should be used to determine timing of first light increase. An assessment of flock uniformity should be made at 140 days (20 weeks) of age or approximately 1 week before the first light increase is planned.

Flocks that are underweight (100 g [0.22 lbs] or more below recommended target weight for age) or uneven (CV% greater than 10 or lower than 70% uniformity) should have photostimulation delayed (by at least 1 week). Transferring to long days before all birds have dissipated photorefractoriness will delay sexual development in those birds that are still photorefractory. This will result in a sexually uneven flock with poor peak rates of lay, widely ranging egg weights, and a flock with difficult-to-manage nutrition.



**Table 23:** Lighting programs for controlled-environment rearing and controlled-environment laying.

AGE (Days)		DAYLENGTH For Flocks with Different CV% at 140 Days (20 Weeks)		LIGHT INTENSITY†
		BROODING DAYLENGTHS* (Hours)		
		CV 10% or Less (70% Uniformity or Greater)	CV 10% or Greater (70% Uniformity or Less)	
1		23	23	80-100 lux (7-9 fc) in brooding area. 10-20 lux (1-2 fc) in the house.
2		23	23	
3		19	19	
4		16	16	
5		14	14	
6		12	12	30-60 lux (3-6 fc) in the brooding area. 10-20 lux (1-2 fc) in the house.
7		11	11	
8		10	10	
9		9	9	
AGE (Days)		REARING DAYLENGTHS (Hours)		
10-147		8	8	10-20 lux (1-2 fc).
Days	Weeks	LAYING DAYLENGTHS (Hours)		
147	21	11‡	8	30-60 lux (3-6 fc).
154	22	12‡	12‡	
161	23	13‡	13‡	
168	24	13‡	13‡	
175	25	13	13	

\* Constant 8-hour daylengths should be reached by 10 days of age. However, if problems have regularly occurred with early body-weight gain, the reduction to a constant daylength may be more gradual so that 8 hours is not reached until 21 days.

† Average intensity within a house or pen measured at bird-head height. Light intensity should be measured in at least 9 or 10 places and include the corners, under lamps and between lamps. During the dark period (interpreted as night) a light intensity of ≤ 0.4 lux (0.04 fc) should be achieved. Ideally, variation in light intensity within the house should not exceed 10% of the mean.

‡ Daylength may be increased abruptly in a single increment without adversely affecting total egg production (although peak may be higher and persistency slightly poorer) provided the body weights are on target and the flock is uniform (CV% ≤ 10 or ≥ 70% uniformity).

During lay, there is no advantage in exceeding 13 to 14 hours of light per day at any stage (where light proofing is good, there is no need to go beyond 13 hours). Giving more than 14 hours of light will advance the onset of adult photorefractoriness and result in inferior rates of lay at the end of the laying cycle. Providing less than 13 hours of light during lay will increase the number of floor eggs as birds will lay eggs before lights-on.

Males reared to the recommended body-weight profile and lighting program will not require increases in daylength ahead of females. Achieving target body-weight profiles with good uniformity will ensure synchronization of sexual maturity between the 2 sexes (see section on *Management into Lay*).

**Light intensity (luminance) in lay**

It is recommended that increases in light intensity are made at the same time as the increase in daylength. However, provided birds have achieved the target body weights and have good uniformity (CV% ≤ 10 or ≥ 70% uniformity), it is the increase in daylength that stimulates sexual maturity and optimizes subsequent laying performance, not changes in light intensity. As long as the minimum intensity at bird head-height in the laying house is greater than 7 lux (0.7 fc), changes in light intensity when the birds are transferred from the rearing to the laying facilities have minimal effect on sexual development and subsequent egg production. The recommended average light intensity at bird-head height in the laying house is between 30 and 60 lux (3 and 6 fc). This brighter intensity is recommended to encourage the use of nest boxes and maximize hatching egg production by minimizing the number of eggs laid outside the nest boxes.



- The maximum response to pre-lay increases in daylength is only obtained by achieving the correct body-weight profile during the rearing period, good flock uniformity, and the appropriate nutritional input.
- Birds should be provided with a constant short daylength (8 hours) by 10 days of age.
- At least 18 weeks of short daylengths (8 hours) are needed during rear to dissipate juvenile photorefractoriness and ensure that all birds are photosensitive when they are transferred to stimulatory daylengths ( $\geq 11$  hours).
- An average intensity of 10-20 lux (1-2 fc) at bird-head height should be provided in the rearing period from 10 days of age.
- Houses must be light-proofed to an intensity of no more than 0.4 lux (0.04 fc) during the dark periods. Any light leakage should be rectified immediately to ensure that the birds do not experience long days in rear.
- The birds' reproductive response is maximized by a 13 or 14-hour daylength in the laying period. This will delay the onset of adult photorefractoriness and will minimize the incidence of floor eggs by ensuring that most eggs are laid after the lights come on.
- An average intensity of 30-60 lux (3-6 fc) at bird-head height should be provided in the laying period.
- Ensure males and females are synchronized in terms of sexual maturity by rearing them on the same lighting program and to the respective target body weights for age.

#### Lighting Programs for Controlled-Environment/Blackout Rearing and Open-Sided Laying House

Where controlled environment rearing to natural environment laying (**Figure 121**) is practiced, daylength should be maintained at 8 or 9 hours (see **Table 24**) from 10 days of age until the flock is photostimulated. In latitudes where problems such as prolapse, broodiness, or high pre-peak mortality frequently occur, it may be advantageous to rear birds on a 10-hour daylength.

**Figure 121:** Example of an open-sided (natural environment) laying house.



The flock should be transferred to open-sided laying houses (i.e. rear and move) or the blackout curtains should be opened (i.e. day-old to depletion) at the same time as the first pre-lay light increase is given (147 days [21 weeks] if the desired age at 5% production is 25 weeks).

There is no benefit to reproductive performance of providing birds with more than 14 hours of light during the laying period. However, where birds are kept in open-sided houses and the longest natural daylength exceeds 14 hours, the combined natural and artificial lighting during the laying period may be increased beyond 14 hours to equal the longest natural daylength. This increase will prevent the birds from experiencing a decrease in daylength after the longest natural daylength has occurred in mid-summer.

To ensure the synchronization of sexual development, rear males and females on the same lighting program.

**Table 24:** Lighting programs for controlled-environment/blackout rearing and open-sided house laying.

		NATURAL DAYLENGTH (Hours) at 147 Days (21 Weeks)							LIGHT INTENSITY†		
		9	10	11	12	13	14	15			
Age (Days)		BROODING DAYLENGTH (Hours) ‡							80-100 lux (7-9 fc) in brooding area. 10-20 lux (1-2 fc) in house.		
1		23	23	23	23	23	23	23			
2		23	23	23	23	23	23	23			
3		19	19	19	19	19	19	19			
4		16	16	16	16	16	16	16			
5		14	14	14	14	14	14	14			
6		12	12	12	12	12	12	12			
7		11	11	11	11	11	11	11			
8		10	10	10	10	10	10	11			
9		9	9	9	9	10	10	10			
Age (Days)		REARING DAYLENGTH (Hours)							10-20 lux (1-2 fc).		
10-146		8	8	8	8	9	9	9			
Age		LAYING DAYLENGTH (Hours) ¶							Artificial lighting 30-60 lux (3-6 fc).		
Days	Weeks	147	21	12#	12#	12#	13#	14		14	15§
154	22	13#	13 #	13#	13#	14	14	14		15§	
161	23	14	14	14	14	14	14	14		15§	

‡ Constant 8-hour daylengths should be achieved by 10 days. However, if problems have regularly occurred with early body-weight gain, reaching the constant daylength may be delayed until 21 days.

† Average intensity within a house or pen measured at bird-head height. Light intensity should be measured in at least 9 or 10 places and include corners, under lamps and between lamps.

# The daylength may be increased abruptly in a single increment without adversely affecting total egg production (although peak may be higher and persistency slightly poorer) provided the body weights are on target and the flock is uniform (CV% ≤ 10 or ≥ 70% uniformity).

§ There is no benefit to be gained from exceeding a daylength of 14 hours. If the longest natural daylength exceeds 14 hours, the combination of natural and artificial light should be increased to equal the expected longest natural daylength.

¶ If problems occur in out-of-season flocks (i.e. delayed sexual maturity), the flock may be photostimulated at 140 days (20 weeks) provided the body weights are on target and their CV% is no more than 10 (no less than 70% uniformity).



- The maximum response to the pre-lay increase in daylength is only obtained by achieving the correct body-weight profile during rear, good flock uniformity, and the appropriate nutritional input.
- Provide birds with a constant short daylength (8 or 9 hours) by 10 days of age.
- During rear, ensure that houses are light proofed to an intensity of no more than 0.4 lux (0.04 fc) during the dark period.
- Where birds are kept in open-sided housing during lay, and the longest natural daylength exceeds 14 hours, the combined artificial and natural lighting may be extended beyond 14 hours to equal the longest natural daylength.
- Ensure males and females are synchronized in terms of sexual maturity by rearing them on the same lighting program and to the respective target body weights for age.

**Lighting Programs for Open-Sided Rearing House - Open-Sided Laying House**

There are four lighting situations in open-sided house rearing (**Figure 122**):

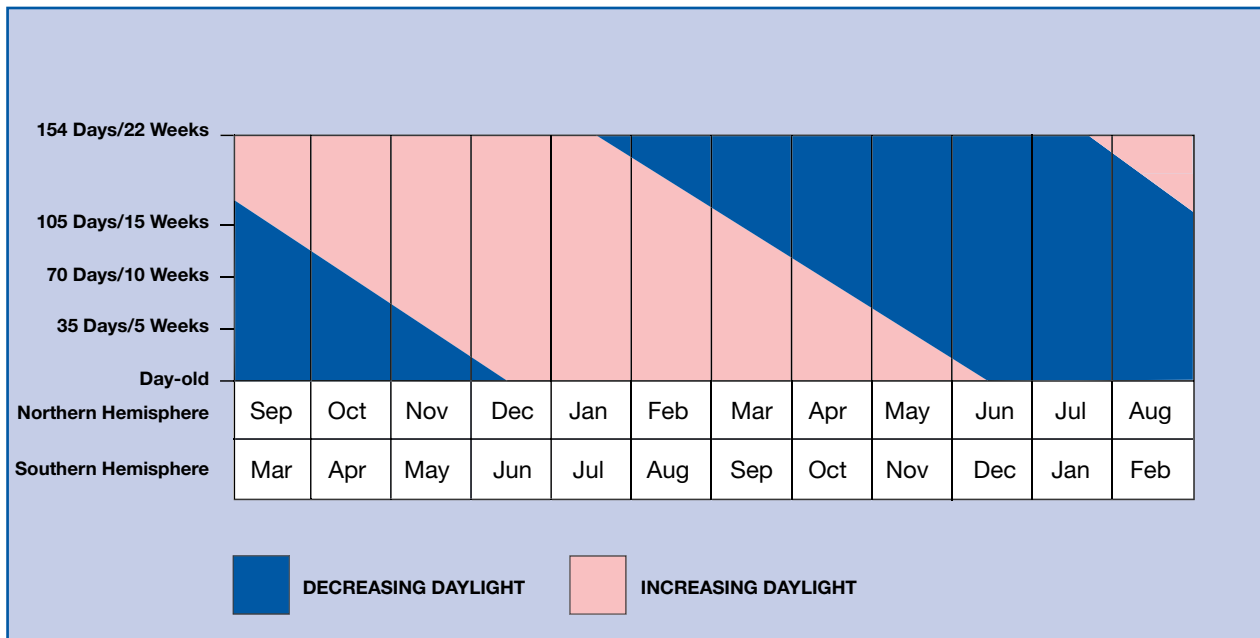
1. Natural daylength increasing throughout the rearing period.
2. Natural daylength increasing at the beginning, but decreasing towards the end of the rearing period.
3. Natural daylength decreasing throughout the rearing period.
4. Natural daylength decreasing at the beginning, but increasing towards the end of the rearing period.

**Figure 122:** Example of an open-sided rearing house where there is no control over the ambient lighting conditions.



These changes in natural daylength patterns are illustrated in **Figure 123**. For each month of placement, different shading/colors indicate the pattern of increasing or decreasing hours of daylight during rear. For example, a flock placed at the start of October in the Northern Hemisphere or April in the Southern Hemisphere will have decreasing natural daylight up to 10-12 weeks, and then increasing natural daylight.

**Figure 123:** Patterns of natural daylength in the rearing period - Northern and Southern Hemisphere.



Note: The actual hours of daylength experienced will vary according to latitude.

In the past there has been concern that rearing birds on an increasing daylength pattern will result in an undesirably early sexual maturity, an increased incidence of prolapse, higher mortality, and smaller eggs. However, it is now known that this does not happen. Broiler breeders are photorefractory and require a period of short days to dissipate juvenile photorefractoriness and become photosensitive. Long daylengths during the rearing period will therefore delay, and not advance, sexual development. Furthermore, the influence of lighting on sexual maturation in broiler breeders is dependent upon achieving the correct feeding regimen and body weight for age. It is therefore recommended that birds reared in open-sided houses are allowed to experience whatever changes occur in the natural daylength during the rearing period.

It is important that broiler breeders are not given artificially long daylengths during the rearing period as has previously been recommended, because this will delay sexual maturity and lead to poor rates of lay at the end of the laying cycle due to an advance in the onset of adult photorefractoriness.

The age at which a flock reaches sexual maturity will depend on the changing patterns of daylength during the rearing period and the size of the increase in daylength given at photostimulation.

The lighting programs given in **Table 25** have been designed to minimize the adverse effects of keeping birds in open-sided housing. However, the performance of flocks reared in open-sided houses will always be poorer than that of flocks kept in controlled-environment or light-proofed houses.

**Table 25:** Lighting programs for open rearing and open house laying.

		NATURAL DAYLENGTH At 10 Days (Hours)						LIGHT INTENSITY†	
		9	10	11	12	13	14		15
Age (Days)		BROODING DAYLENGTH (Hours)						80-100 lux (7-9 fc) in brooding area.	
1		23	23	23	23	23	23		23
2		23	23	23	23	23	23		23
3		19	19	19	19	19	19		19
4		16	16	16	16	16	16		16
5		14	14	14	14	14	14		15
6		12	12	12	12	13	14		15
7		11	11	11	12	13	14		15
8		10	10	11	12	13	14		15
9		9	10	11	12	13	14	15	
Age (Days)		REARING DAYLENGTH						Natural light intensity.	
10-146 days		Natural lighting							
		NATURAL DAYLENGTH (Hours) at 147 Days (21 Weeks)							
		9	10	11	12	13	14		15
Age		LAYING DAYLENGTH (Hours)						Supplementary artificial lighting 30-60 lux (3-6 fc), but 60 lux (6 fc) for spring-hatched flocks.	
Days	Weeks								
147	21	12#	13#	14	14	14	14		15§
154	22	13#	14	14	14	14	14		15§
161	23	14	14	14	14	14	14	15§	

† Average intensity within a house or pen measured at bird-eye height.

# The daylength may be increased abruptly in a single increment without adversely affecting total egg production (although peak may be higher and persistency slightly poorer) provided the body weights are on target and the flock is uniform (CV% ≤ 10 or ≥ 70% uniformity).

§ There is no benefit to be gained from exceeding a daylength of 14 hours, if the longest natural daylength exceeds 14 hours the combination of natural and artificial light should be increased to equal the expected longest natural daylength.



- The maximum response to pre-lay increases in daylength is only obtained by achieving the correct body-weight profile during the rearing period, good flock uniformity and the appropriate nutritional input.
- If reared in open-sided housing, broiler breeders should be allowed to experience whatever changes occur in the natural daylength. Never rear birds on artificially long days ( $\geq 11$  hours), even for spring-hatched or out-of-season birds, as this will delay sexual maturity, and egg numbers will be reduced.
- Where birds are kept in open-sided housing during lay and the longest natural daylength exceeds 14 hours, the combined artificial and natural lighting may be extended beyond 14 hours to equal the longest natural daylength.
- Ensure males and females are synchronized in terms of sexual maturity by rearing them on the same lighting program and to the respective target body weights for age.

### **Artificial lights and light intensity**

In open-sided housing, it is important that the light intensity provided during the period of artificial lighting is bright enough to ensure photostimulation. The target light intensity in the house is 30-60 lux (3-6 fc). During times of the year when flocks have been reared in high-intensity natural light (i.e. spring-hatched birds), higher intensities of artificial light will need to be provided in the laying house. This light intensity is essential to ensure satisfactory reproductive performance.

Supplementary artificial lighting should be given at both ends of the natural day. This will clearly define the birds' day and ensure that the daylength does not vary from that desired due to changes in sunrise and sunset. The transition from natural darkness to artificial lighting in the morning will give a definite "dawn" signal to the birds, and the transfer from artificial lighting to natural darkness will give a definite "dusk" signal. The latter is important because it is dusk that controls the timing of ovulation and, as a consequence, the time of egg laying. The proportion of artificial lighting given at each end of the birds' day will depend upon management factors such as what time the farm staff start work and when eggs are required for collection.

In open-sided houses, seasonal effects can be significantly reduced if the intensity of the natural light entering the house is reduced. The use of black plastic horticultural netting for example will reduce the intensity of the light entering the house while still allowing adequate ventilation. The netting should be removed at the first pre-lay light increase.



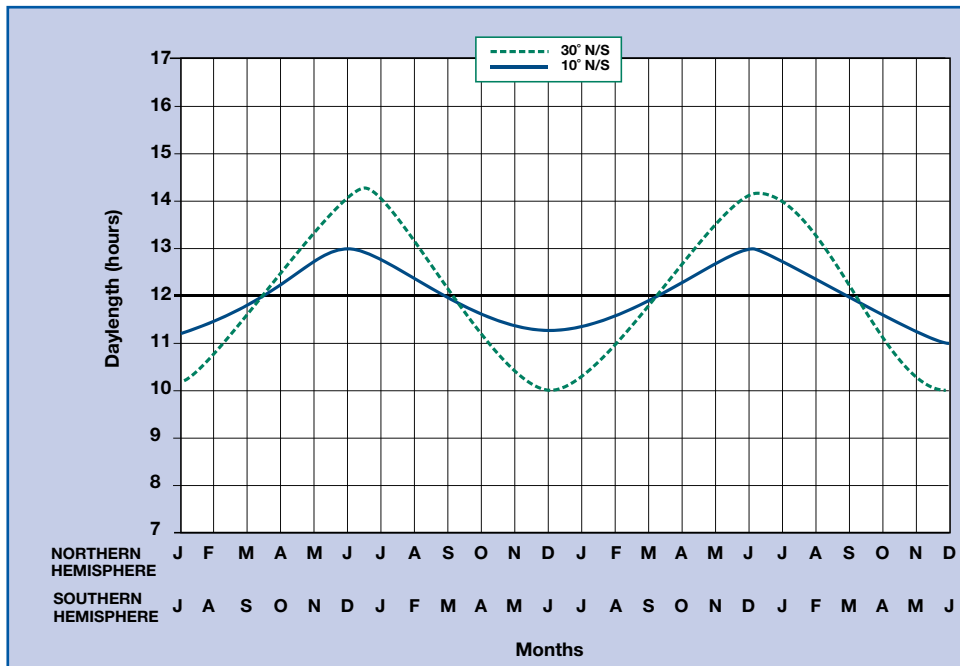
- Birds may be slower to come into lay if the artificial light intensity at the first pre-lay light increase is less than 60 lux (6 fc) when they have been reared on high-intensity natural daylight.
- Artificial light should be given at both ends of the day to maintain a fixed daylength.

### **Seasonal variations in natural daylength**

When rearing and/or laying houses are open-sided, seasonal variations will affect performance. Seasonal changes are gradual and so a precise definition of whether certain months of the year are classified as in- or out-of-season is difficult to establish. Some months are neither one nor the other. Latitude will influence seasonal effects (see **Figure 124**).



Figure 124: Natural daylengths at latitude 10° or 30° north or south.



The months in which the birds are placed are classified as in-season or out-of-season in Table 26.

Table 26: Classification of months of placement as in-season or out-of-season.

IN-SEASON		OUT-OF-SEASON	
Northern Hemisphere	Southern Hemisphere	Northern Hemisphere	Southern Hemisphere
September	March	March	September
October	April	April	October
November	May	May	November
December	June	June	December
January *	July *	July *	January *
February *	August *	August *	February*

\* These 4 months are difficult to define. The degree of seasonal effect in these months will depend on latitude. Slight modifications of the lighting programs and body-weight profiles may be necessary.

**Out-of-season flocks**

The age at onset of lay for flocks hatched between March and August in the Northern Hemisphere, and between September and February in the Southern Hemisphere, will be delayed due to the birds having no or insufficient short days (8-10 hours) to satisfactorily dissipate photorefractoriness and make the birds photosensitive. Compared to in-season flocks, out-of-season flocks will come into production later and have lower peaks, larger eggs, and less predictable reproductive performance throughout lay. Sexual maturity for out-of-season flocks can be advanced by easing the degree of body-weight control (see the **Ross Parent Stock Performance Objectives** for more information). Growing out-of-season females to a heavier out-of-season body-weight target will allow photorefractoriness to be dissipated more rapidly, helping to reduce issues of egg production and egg size.

The performance of spring-hatched (out-of-season) birds can be improved by rearing them in brown-out housing (use of netting to reduce light penetration into the house) on short (8-10 hours), artificial daylengths. However, it is unlikely that production from out-of-season flocks will ever be as good as that from in-season (autumn-hatched) flocks. The pre-lay light increase should be given at 147 days (21 weeks) - if desired age at 5% production is 25 weeks - and given as a single increment to 14 hours or 15 hours where the longest anticipated natural daylength is longer than 14 hours.

***In-season flocks***

In-season flocks should be grown to the target body-weight profile and the first pre-lay light increase given at 21 weeks (147 days) to achieve 5% at 25 weeks of age.



- The lighting program for both in-season and out-of-season flocks is the same (see **Table 25**).
- Out-of-season birds should be grown to a heavier out-of-season body-weight profile.
- In-season birds should follow the standard target weights.

**Wavelength (Light Color) and Lamp Type**

There is no strong scientific evidence to show that one particular color of light gives better performance than white light (warm white, 3000K), which contains all colors of the light spectrum.

There may be some beneficial effects on fertility from providing UV-A in addition to white light (natural light has about 7% UV-A). Broiler breeders have UV-A reflective markings on their plumage, and the provision of UV-A light may aid bird recognition. There is some evidence that females use this factor to choose individual males, while males are more active and perform a greater number of attempted matings when UV-A light is provided.

There are no data to show that one type of lamp induces better performance than any other, and so lamp choice will depend on availability, capital outlay, running costs, and the ability to dim using conventional voltage-reduction equipment.



- There is no need to provide broiler breeders with anything other than white light.
- Lamp type does not have an effect on reproductive performance.

## Section 8 - Nutrition

### Nutrition

#### Objective

To maximize welfare, reproductive potential (of both males and females), and chick quality by supplying a range of balanced diets that meet the requirements of parent stock at all stages of development and production.

#### Principles

Maintaining good uniformity and keeping close to body-weight targets are essential in feeding parent stock. Feed composition, feed form, feeding management, and general management must be considered together when assessing parent stock performance. Economic analysis of the whole broiler production cycle shows that small improvements in breeder or chick performance will cover the costs of improving nutrient levels in the breeder feed. In general, a high-quality diet for parent stock is economically justified.

#### Broiler Breeder Nutrition

Feed formulation and feeding management are combined to achieve target body weights and good uniformity throughout the life of the breeder flock.

Nutrition is the major impacting variable upon both productivity and profitability in parent stock flocks and although the formulating and balancing of diets is a precision activity requiring specialist nutrition skills, farm managers should be aware of the nutritional content of their feeds. Such information can be obtained from the feed suppliers themselves or nutritional consultants. Most importantly, there should be farm-level sub-sampling of diets and routine laboratory analysis to determine if expected dietary nutrient contents are being achieved. It is important that managers are aware of the make-up of the diet that is being fed to their stock to ensure that:

- Feed levels and consumption will provide adequate levels of daily nutrient intake (**feed intake x nutrient concentration**).
- There is proper and expected balance between feed nutrients.
- Routine laboratory analysis of diets can be usefully interpreted and correct actions taken such as:
  - « Alerting the provider of a possibility of discrepant formulation.
  - « Appropriate management of feeding programs.

#### Supply of Nutrients

Diets should be balanced on the basis of the intake of digestible nutrients. An excess or deficiency of any key nutrient could negatively impact total flock and progeny performance.

In practice, the supply of nutrients to parent stock is controlled through the nutrient composition of the feed and the level of feed intake, and these must always be considered together as changes in either one of these factors will impact supply of nutrients. As daily supply (intake) of nutrients such as energy and amino acids is a determinant of flock performance, the effect of changing either feed nutrient composition or feed allocation on nutrient intake must always be considered.

Guidelines for daily feed intakes and for adjusting them according to observations of bird performance, have been discussed in earlier sections of this Handbook. These guidelines are made with reference to the dietary energy levels given in the recommended **Ross Parent Stock Nutrition Specifications** for starter, grower and breeder diets.

While recommended nutrient specifications are given as dietary concentrations, it is the actuality of required daily nutrient intakes (i.e. the amount of nutrients that the bird requires in a day at any given time in its life) that should be considered when making feeding decisions. This is especially important when feed intakes may vary, such as when high temperatures result in lower feed intake.

**Feed Intake**

Daily feed intakes per bird are influenced by both genetic and environmental circumstances. Control of feed supply is a major mechanism for effective flock management, and therefore feed intake expectations are important both to determining required diet nutrient density and to making management decisions.

The daily bird requirement for a nutrient is satisfied by the product of presumptive feed intake and nutrient concentration. Recommendations for nutritional concentrations, as in the **Ross Parent Stock Nutrition Specifications**, assume the achievement of feed intakes as given in the **Ross Parent Stock Performance Objectives**.

**Energy**

Feed energy is now conventionally expressed as apparent metabolizable energy level corrected to zero nitrogen retention (AMEn), as these values are the more accurate description of energy value. Data on energy contents expressed in this way are available from many sources. In this Handbook, the term ME is used to describe AMEn.

Recommended feeding levels in the **Ross Parent Stock Performance Objectives** assume a given dietary energy level per kg for starter, grower and laying flocks. Because birds respond to nutrient intake (not nutrient concentration), if diets have feed nutrient levels different from those assumed, then proportional changes in feed allowances must be made. An example of the calculation is given below:

<b>METRIC</b>	<b>Energy intake = 166 g/bird/day x (2,800 kcal/kg ÷ 1000) = 464.8 kcal/bird/day</b>
	<b>Adjusted feed intake = 464.8 kcal/bird/day ÷ (2,700 kcal/kg ÷ 1000) = 172 g/bird/day</b>
<b>IMPERIAL</b>	<b>Energy intake = 36.6 lb/100 birds x 1,269 kcal/lb = 46,445.4 kcal/100 birds</b>
	<b>Adjusted feed intake = 46,445.4 kcal/100 birds ÷ 1,224 kcal/lb = 37.9 lb/100 birds</b>

The total daily energy need for a bird is the sum of energy required for maintenance, growth and production of egg mass. The maintenance energy requirement is by far the largest component of total energy need. Maintenance energy need is based on the bird's body weight and is significantly affected by environmental temperature. Total energy requirement will, therefore, vary with environmental temperature, location and season. Adjustment of energy supply must therefore be based largely on observation of the birds' responses in body weight, body condition, feed clean-up time, and egg mass.

The choice of dietary energy level is a combination of feed management, welfare and economics. In particular circumstances, varying the feed energy level may be justified if feed intakes are not on target, or if economics dictate a change in feed energy level. If feed energy levels differ from those suggested in the recommended nutrition specification tables, then not only must feed allowance quantities be adjusted accordingly, but the concentrations of other nutrients in the diets must also be adjusted, in order to maintain a constant ratio of these nutrients to energy. These adjustments are necessary to ensure that the appropriate daily intake levels of required nutrients are achieved. As an example, the adjustment calculation for methionine is given below:

<b>METRIC</b>	<b>Aviagen recommended digestible methionine in grower diet = 0.35% at baseline diet energy value of 2,800 kcal/kg</b>
	<b>Actual diet energy value = 2,700 kcal/kg</b>
	<b>Adjusted % digestible methionine = 0.35% x (2,700 kcal/kg ÷ 2,800 kcal/kg) = 0.337</b>
<b>IMPERIAL</b>	<b>Aviagen recommended digestible methionine in grower diet = 0.35% at baseline diet energy value of 1,269 kcal/lb</b>
	<b>Actual diet energy value = 1,224 kcal/lb</b>
	<b>Adjusted % digestible methionine = 0.35% x (1,224 kcal/lb ÷ 1,269 kcal/lb) = 0.337</b>
	<b><i>This correction should be done for all nutrients, minerals and vitamins.</i></b>

Adequate supply of energy is critical for optimal productivity and persistency. When energy supply appears to be the limiting factor (e.g. if production performance targets are not achieved), additional feed should be given. However, when a nutrient other than energy is limiting performance, the provision of additional feed may lead to excess energy intake, leading to excessive body-weight gain and improper ovarian development. If energy supply is adequate and another nutrient is too low, then the feed must be reformulated to give the properly required nutrient balance.

Energy contents of successive feeds should not vary widely. Feed changes should be gradual and carefully controlled, especially when changing diets (e.g. transition from Grower to Breeder rations).

Within a given diet, consistency in nutrient density and quality is critical. Ingredients that are variable in nutrient composition and digestibility should be used with caution. Avoid large changes in feed ingredients and energy concentrations between deliveries to a given flock.

### Protein and Amino Acids

Feed protein concentration must be sufficient to ensure that requirements for all essential amino acids are met. Amino acids provide the building blocks for body tissue, feather and egg protein, and for the replacement of proteins lost in the natural processes of daily protein turnover. Dietary protein content must provide the different amino acids at the optimum daily rate, ensuring they are in balance with one another and dietary energy.

Variation of feed protein content should be minimized. Excessive protein intake may lead to over-fleshing (increased breast meat deposition) and negatively affect fertility. In contrast, inadequate protein intake can lead to a reduction in egg size and feathering problems.

In general, it is preferable, especially under hot conditions, to feed readily digestible protein sources.

Specific nutrient recommendations are given in the **Ross Parent Stock Nutrition Specifications**. Amino acid levels are listed for those major essential amino acids that are most likely to be limiting in practical feeds. The digestible amino acids are based on true fecal digestibility. Formulating diets on a digestible amino acid basis results in a better-balanced protein in the feed, which better meets the bird requirements. Crude protein and amino acids are given as total g per kg (for % divide by 10).

### Macro Minerals

The macro minerals calcium (Ca) and phosphorus (P) are critical for proper skeletal development, reproductive performance, shell quality, and other metabolic functions.

Laying hens require 4-5 g of calcium per hen per day (14-18 oz of Ca per 100 birds) to maintain Ca balance. In practice, this requirement is satisfied by feeding recommended breeder ration Ca levels no later than 5% egg production.

To maintain optimal shell quality, consider supplementing 1.0 g (0.03 oz) Ca per bird per day in the form of a large particle-sized limestone (diameter 3.2 mm [0.125 in]) or oyster shell. This is particularly relevant when feeding pelleted diets where finely ground limestone is often used in the diet as the calcium source to minimize pellet die wear. When birds are fed early in the day, the smaller particle-sized limestone in the feed is rapidly absorbed and excreted via the kidney long before the egg shell is laid down during the evening. Thus, provision of a larger particle calcium source during the afternoon can improve shell quality by ensuring Ca is present in the gut during shell formation. One effective way to provide this supplement is to evenly broadcast it on the house litter area. However, supplemental Ca sources should not be allowed to build up in the litter since excessive Ca intake can be detrimental to shell quality. If build up of the calcium supplement in the litter does occur, supplementation should be discontinued until the flock has consumed any supplemented Ca remaining in the litter. If mash feeds are used, large particle-sized limestone or oyster shell can easily be incorporated into the diet.

Adequate available phosphorus (P) intake is critical for skeletal structure and egg shell quality. Excessive levels of available P throughout lay reduce shell quality and have a negative impact on hatchery performance (hatchability). Feeding recommended available P levels will ensure adequate egg shell quality.

Levels of sodium (Na), chloride (Cl), and potassium (K) above required levels will likely lead to increase in water intake, in turn negatively impacting litter quality and egg shell quality. It is important to control dietary levels of these nutrients to avoid such problems from occurring.

### Phytase

The addition of phytase to the feed to release available P from plant materials and thus to partially replace the need for inorganic phosphates in the diet is common practice. If phytase is added to the diet, it is important that it is used according to manufacturer recommendations; otherwise mineral-related deficiencies can occur.

### Mineral Imbalance and Metabolic Disorders

Calcium Tetany of broiler breeder hens is occasionally seen with mortality appearing from 25 to 30 weeks of age. Hens suffering from Calcium Tetany are found paralyzed or dead in the nest in the morning with active ovaries and an egg in the shell gland with a partially formed shell. No other pathology may be observed on post mortem. The occurrence of this condition is rare when the recommendations concerning feeding of calcium are followed.

Low available P and K can lead to Sudden Death Syndrome (SDS). The SDS of broiler breeders occurs in early lay with birds dying suddenly in the breeder house. At postmortem there is an enlarged flaccid heart, congested lungs, and pericardium in some birds. The SDS-affected flocks usually respond to K supplementation in the drinking water and increases in the feed. Ross stock has a low susceptibility to SDS.

### Added Trace Minerals

Recommended levels of supplementation for trace minerals in the premix can be found in the **Ross Parent Stock Nutrition Specifications**. Generally speaking, organic chelated trace elements have higher biological availability than inorganic sources. When using inorganic sources of trace minerals, the sulfate form generally provides the highest biological availability

### Added Vitamins

Vitamins are critical to all aspects of growth, reproductive performance and progeny. Under demanding conditions, disease outbreaks and other situations, birds can show a positive response to higher levels of certain vitamins. The goal should be to remove or reduce stress factors, rather than to depend on permanent use of excessive vitamin supplementation for optimal performance.

A major source of variation in supplementation for some vitamins is cereal type. Accordingly, separate recommendations have been made for vitamin A, nicotinic acid, pantothenic acid, pyridoxine (B6), and biotin in maize-based versus wheat-based feeds in the **Ross Parent Stock Nutrition Specifications**.

Vitamin potency is sensitive to many factors (e.g. moisture, trace minerals, and heat) that can reduce its shelf life. Quality control measures must be in place to ensure vitamin levels in the finished feed meet the recommended nutrient specifications. The time period for feed to go from the feed mill to being consumed by the breeder flock should be as short as possible. Feed deliveries should be scheduled so that feed does not reside in farm feed bins for excessive periods of time (i.e., >10 days). This is especially important under conditions of high temperature and humidity, which will accelerate overall feed quality degradation. By using appropriate mold inhibitor compounds (e.g. propionic acid based mold inhibitors), the risk of mold growth and subsequent mycotoxin production can be reduced.

Vitamin E is one of the most expensive vitamins and has several biological functions impacting the immune and reproductive systems, so it is important to ensure that levels of this vitamin in the diet remain within recommended levels. Research has shown that recommended levels also enhance the immune system of newly hatched chicks. Recommendations for all vitamins are included in the **Ross Parent Stock Nutrition Specifications**. Problems that can be caused by vitamin deficiencies are detailed in **Appendix 7** at the back of the Handbook.



- Knowledge of the nutrient composition of the diet being fed is necessary to assure quality control of diet supply and to correctly manage feeding levels.
- Knowledge of dietary energy is especially important because nutritionists balance dietary nutrients to energy concentration. Feeding levels must be altered accordingly in response to changes in dietary energy concentration.
- Feed should not be stored on the farm and should be used within 10 days of delivery.
- Specific performance problems may be resolved by attention to concentrations of specific nutrients, but in general - provided diets are properly formulated - the greatest effects of diet upon performance are through non-optimum feed intake levels.



## Feeding Programs and Diet Specifications

Feed specifications and feeding management must always be considered together. Different feed specifications may be used with equal success provided they lead, together with the feed management procedures, to the required bird performance. The main factors influencing feed specifications include cost and availability of feed ingredients, feed processing technology, and bird management procedures.

Feed should be formulated to meet nutrient specifications and be consistent over time. Sudden changes in feed ingredients or changes in other characteristics that may reduce feed intake, even transiently, should be avoided. Feed management and composition must be guided by close monitoring and observation of the flock.

### Starter Period

A feature of successful breeder performance is to achieve proper early growth and physiological development. It is possible to achieve this with one Starter feed.

Starter feed should preferably be provided as a sieved crumb. Typically, the Starter feed will be given for about 28 days.

Take care to avoid presenting partially ground pieces of grain to the chicks that they can preferentially select from the diet. Individual chicks will select these large pieces to the exclusion of the crumbles and consequently receive an imbalanced diet.

A Grower feed will follow immediately after the Starter feed. This Grower feed will generally contain lower crude protein and amino acid specifications than the Starter feed to control body-weight gain.

During changes from Starter to Grower feed, body weight should be monitored carefully to safeguard against checks in growth. This is especially important when there is a change in feed ingredients and/or feed form.

If problems are consistently experienced in achieving target body weights by 28 days (4 weeks), then feeding the Starter diet for another 1-2 weeks may be helpful.

### Growing Period

During the growing period, daily growth rates are low and nutrient requirements, when expressed as daily intakes, are small. However, it is important to maintain good feed quality in this period, and to avoid the use of poor-quality feed ingredients.

During the growing period when feed volumes are lower and where the feeding equipment does not distribute it throughout the house rapidly enough, flock uniformity can suffer. In such situations it may be necessary to lower the energy level of the feed to allow feed levels to be increased and to support good flock uniformity. If lower energy levels are used, it is important that the ratio of other nutrients to energy are kept constant.

Several different feeding strategies can be followed to lead to successful production. For example, if photostimulating birds earlier than 21 weeks of age, it may be beneficial to use 4 diets (rather than 2) during the rearing phase. This will help to ensure that the birds receive adequate nutrients at the correct time in order to achieve an earlier onset of production. A 4-stage rearing program includes:

- Higher nutrient density Starter diet to support adequate early development - particularly for males.
- Second Starter diet to provide a smoother transition to a lower-specification Grower diet.
- Lower-density Grower diet to allow greater control of body-weight development and increase feed distribution during this period. Although the diet itself has a reduced concentration of nutrients per kg, the recommended feed intakes and increasing feed consumption over this phase of growth will ensure the required increase in daily nutrient supply.
- Pre-breeder diet to provide higher amino acid and protein intake for adequate development of reproductive tissue.

### Transition to Sexual Maturity

Sufficient amino acids and other nutrients are required for the proper development of reproductive tissues. Provision of supplemental vitamins in pre-lay and early lay periods will increase body tissue levels before egg production commences and may provide a benefit in early hatchability.

### The Laying Stage

Feed compositions given in the **Ross Parent Stock Nutrition Specifications** will support target levels of production in properly reared, uniform flocks. Performance during the laying stage is often affected by feeding and management practices applied during earlier stages of growth. Increasing feed allowances because of poor egg production should be undertaken with caution and a clear understanding of the flock's nutritional status.

In most flocks, using more than one breeder feed may not be nutritionally necessary. Slightly reduced daily requirements of amino acids are normally fully covered by feed intake reductions post-peak. Calcium requirement increases in older birds and can be satisfied by providing a calcium supplement in the laying house instead of providing additional calcium in the feed.

Supplementary phosphorus may be provided if higher levels are needed in the earlier stages of lay to control SDS. Otherwise, available phosphorus should be kept at the recommended levels.

An economic case can be made for a Breeder-2 and Breeder-3 ration with lower protein and amino acids and lower available phosphorus levels, and a higher calcium concentration. Additionally, **Ross Parent Stock Nutrition Specifications** advise a 3-stage feeding program in production to optimize nutrient needs, feed costs and body conditioning.

Over-sized eggs are often associated with overfeeding. Therefore, it is prudent to evaluate all the elements of nutrient supply and feed intake levels if this is a problem.

### Temperature Effect on Energy Requirements

Environmental temperature is a major factor influencing energy requirement of the bird. As operating temperature differs from 20°C (68°F), energy intakes should be adjusted pro rata as follows:

- Increased by 0.126 MJ (30 kcal) per bird per day if temperature is decreased by 5°C from 20 to 15°C (68 to 59°F).
- Reduced by 0.105 MJ (25 kcal) per bird per day if temperature is increased by 5°C from 20 to 25°C (68 to 77°F).

The influence of temperatures above 25°C (77°F) on energy requirement is not as straightforward as the effect of cold. At temperatures above 25°C (77°F), feed composition, feed amount, and environmental management should be controlled to reduce heat stress. Providing correct nutrient levels and using feed ingredients with higher digestibility will help to minimize the effect of heat stress. Increasing the proportion of the feed energy that comes from feed fats (rather than carbohydrates) may also be beneficial.

In addition to absolute temperature measurement, the effective temperature of birds can be monitored by measurement of bird performance against the target and observation of bird behavior.

### Male Nutrition

Separate control of male feeding level using separate-sex feeding systems is essential for successful broiler breeder production. The use of a separate feed (a separate diet formulation with different nutrient concentrations) for males is not as clear-cut but may provide improvements in flock fertility.

The use of a single feed for both sexes is a widespread practice; however, the use of a specific male diet in the laying period has been shown to be beneficial to the maintenance of male physiological condition and fertility. A separate male diet with lower protein and amino acid levels can prevent excessive breast muscle development, while adequate dietary supplementation of vitamin E and selenium (Se) are critical for sperm quality. The use of an organic chelated form of Se should be considered.

If a separate male diet is used, it should be introduced when birds are moved to the laying house or at light stimulation. When switching to a separate male diet, ensure caloric intake is not reduced if the male diet is lower in energy density than the diet currently being fed (dietary energy levels for a separate male diet should be between 10.9 and 11.7 MJ (2600 and 2800 kcal ME per kg).



- Birds respond to daily intakes of nutrients. Therefore feeding programs (and feed levels) must relate to dietary nutrient content, especially energy and the nutritional requirements of the bird at a given age.
- Economic and management practices may demand flexibility in diet nutrient concentration, but in general, variability in nutrient specification should be avoided.
- Nutritional problems will be observed as failures to achieve production and welfare targets and should be discussed with the nutritionists at the earliest opportunity.
- Diets need to be regularly sampled and the samples analyzed to ensure that the diet is as it should be.

## Feed Manufacturing

Following good feed manufacturing practices will ensure that parent stock receive diets with adequate nutrient fortification, while minimizing potential contaminants. Unseen variations in feed ingredient quality and nutrient content are possible causes of bird failure to attain production targets. Frequent and routine control checks upon the physical quality and nutrient content of feed should therefore be completed.

Feeds should be regularly handled and examined by nose and eye (and if necessary microscope). Sub-sampling and analysis of feeds is essential to detecting anti-nutritional factors and ensuring that requirements for specific nutrients are being met.

Ingredient formulations, and their alteration with changing ingredient price, should be a subject for discussion with the feed manufacturer, and by close examination of declarations of ingredients and specifications.

- Raw material physical quality, ingredient nutritional content, and feed processing techniques must be of a high standard and consistent from batch to batch for a given flock.
- Ingredients must be free of contamination by chemical residues, microbial toxins, pathogens, and mycotoxins.
- Raw materials should be as fresh as possible within practical limitations and should be stored under controlled conditions.
- Storage facilities must be protected from contamination by insects, rodents, and in particular, wild birds, all of which are potential carriers of disease.
- Breeding stock can be fed successfully on mash, crumbled or pelleted feed, as long as good feeding management is practiced.
- Provide feed as fresh as possible. The risk of nutrient degradation and mold growth in feed increases as a given feed delivery remains in the farm feed bin.

Alterations to the inclusion levels of specific diet ingredients - feedstuffs - are the major means by which feed manufacture can be optimized in terms of nutrient content, palatability, and price. A table is given in **Appendix 7** that allows managers to assess the likely consequences of changes to feed ingredient inclusions upon the concentrations of diet nutrients.

### Raw Materials

Many feed ingredients are suitable for feeding to parent stock. Supply and price will usually determine the choice; however a few general guidelines may be given.

When comparing cereal sources, maize has been found to give performance advantages in the laying period when compared to wheat. Birds fed maize-based rations consistently have improved egg shell quality compared with hens fed wheat-based feeds. Better egg shell quality leads to improved yield of hatching eggs, less bacterial contamination, and improved hatchability.

Feed fats and oils should be used at modest levels at all stages. In general, a minimum inclusion of 0.5-1.0% added fat is recommended to reduce dustiness, improve absorption of fat soluble nutrients, and enhance palatability.

### Feed Processing

Breeding stock can be fed successfully on mash, crumbled or pelleted feed, as long as good feeding management is practiced. The feed form is highly dependent on available feed ingredients and feed compounding facilities.

- **Mash:** A good-quality mash extends clean-up time compared to crumble or pellet forms, and therefore allows all birds the opportunity to eat the recommended feed amount. This will support good body weight development and uniformity. However, mash feed can be inconsistent due to particle segregation of low- and high-density feed ingredients as the feed is transported and conveyed onto the farm. Poor-quality mash (e.g. that with a particle size that is too small) can increase the risk of mash bridging in farm feed bins.
- **Crumble:** A good-quality crumble will reduce clean-up time compared to mash and offers a lower chance for particle segregation of the dietary ingredients compared to mash.
- **Pellets:** A good-quality pellet is preferred if clean-up time is a concern (e.g. during high environmental temperatures). If floor feeding is applied, a good-quality pellet is critical.

### Feed Hygiene (Heat Treatment)

All feed must be considered a potential source of bacterial infection, particularly coliforms and Salmonellae, and should be decontaminated if total bacterial pathogen control is required. Thermal processing involves treatment with adequate heat in a retention vessel at atmospheric pressure for sufficient time to kill the organism. For parent stock feed, temperature and exposure to heat varies within region and with equipment capability and can range from as little as 15 seconds to as much as a couple of minutes. Heat treatment should be enough to reduce the total viable bacterial counts to less than 10 organisms per gram.

Pelleting alone will not completely eliminate harmful bacteria from feed (although it may reduce the contamination below detectable levels in tests of finished feed). Care must be taken not to re-contaminate feed. Critical control points for the prevention of re-contamination include the cooling, storage, and transportation of feed from the feed mill and into the feed lines and feeders. Where feed thermal treatment is not available, safe and permitted additives can be a viable option.

When feeds are heated, consideration should be given to components that may be damaged by heat (e.g., vitamins and amino acids). The vitamin levels recommended in the **Ross Parent Stock Nutrition Specifications** will cover losses from conventional conditioning and pelleting of the feed. However, more severe heat treatment may require for vitamins and/or amino acid to be fortified. There may also be changes (positive and negative) in nutritional value due to structural changes in the feed.

### Finished Feed

Quality control is essential. A program of monitoring the quality of finished feed is necessary, which should include both feed mill and farm sampling. It is assumed that feed manufacturing site personnel will take representative feed samples from production runs. At the farm level, it is useful to take and retain feed samples from each feed delivery. In the event flock performance problems occur, these samples are then available for additional analysis to help identify or exclude nutritional issues.

Samples should ideally be taken inside the house from one of the feed hoppers. Target a sample size of approximately 1,000 g (2.2 lbs). Place the sample in a sealable plastic bag and store in a cool, dry area until the flock is depleted.

Some of the consequences of not meeting the dietary nutrient specifications are summarized in **Table 27**.

**Table 27:** Consequences for the laying flock of not meeting the nutrient specifications.

	Effect of Undersupply	Effect of Oversupply
Crude protein	Depends on amino acid levels, but generally decreased egg size and number. Poor chick quality from young flocks.	Increased egg size and lower hatchability. Increased metabolic stress during hot weather conditions.
Energy	Body weight, egg size and egg number will decrease unless feed quantity is adjusted.	Excess leads to increased double yolks, oversized eggs and obesity. Late fertility/hatchability suffers.
Lysine, methionine & cystine	Decrease egg size and number.	
Linoleic acid	Decreased egg size.	
Calcium	Poor shell quality.	Reduced availability of nutrients.
Available phosphorous	May impair egg production and hatchability. Reduced bone ash in chicks.	Poor shell quality.



- Failure to achieve production targets can be due to unseen variations in feed ingredient quality and nutrient content.
- Quality control of the finished feed both at the feed mill and on farm is essential.
- Managers should be in constant dialogue with their feed nutritionist and their feed manufacturer to be aware of any changes made to ingredient formulation or nutrient specification.

## Water

Water is the most important nutrient for life. Unlimited, clean, fresh water should be available to birds at all times when the birds are active. As a general rule, in rear, the ratio of water intake to feed intake is at a minimum 1.6:1 (water: feed) at 21°C (69.8°F), although this will vary with drinker type. In lay, water intake may be expected to be higher than this. Water requirement will vary with feed consumption and will increase with ambient temperature. In some areas, the sodium content of water is high and adjustments in feed formulation need to be made to prevent overconsumption of water. Detailed information about drinker systems and water quality can be found elsewhere in the other sections of this Handbook.



- Water is an essential ingredient for life and birds should have unlimited access to clean, fresh water at all times when the birds are active.

**Notes**

A series of horizontal dotted lines for taking notes.



## Section 9 - Health and Biosecurity

### Health and Biosecurity

#### Objective

To achieve hygienic conditions within the poultry house and to minimize the effect and prevent the spread of any disease should it occur. To attain optimum performance and bird welfare, and to provide assurance on food safety issues.

#### Principles

Hygienic conditions within the poultry house are achieved through the implementation of correct biosecurity, cleaning and disinfection, vaccination programs and good management practices.



#### Other Useful Information Available

Veterinary How To: *Take FTA Samples*

Veterinary How To: *Take Tissue Samples for Histopathology*

Veterinary How To: *Take Bacterial Culture Samples*

Aviagen booklet: *Marek's Disease Virus*

#### The Relationship Between Management, Disease Expression and Bird Welfare

The incidence and severity of many diseases, and bird welfare, is affected by the circumstances experienced by the birds. The management systems described in this Handbook are designed to maximize production by optimizing bird welfare in parent stock. Where it may prove impossible to exclude a pathogen in a particular situation, the commercial effects of a disease may be minimized by reducing the challenges deriving from other sources.

The overall balance of correctly applied management factors is important as many factors interact with each other to increase the severity of symptoms seen as a result of infection. When defining control measures for disease, and therefore bird welfare, it is important to take into account the possible incidence of conditions such as:

- Poor feed management and other factors that can precipitate problems of Staphylococcal or E.coli infections such as synovitis.
- Overstimulation of birds can be associated with peritonitis, increased double yolked eggs, Erratic Oviposition and Defective Egg Syndrome (EODES), and polyclonal E.coli septicaemia at point of lay.
- Control of water supply to reduce unnecessary water leakage and/or poor litter management can cause problems with coccidiosis, staph arthritis/tendonitis, pododermatitis and poor egg hygiene.
- Stocking density, biosecurity, vaccination and control of immunosuppressive infections e.g. Marek's Disease, Reovirus, Infectious Bursal Disease (IBD), Chicken Anaemia Virus (CAV) and some mycotoxins, can markedly affect the severity of other diseases.

## Hygiene Management

Strict operation of a comprehensive program of hygiene management is essential if proper attention is to be given to:

- Site biosecurity.
- Site cleaning.

### Biosecurity

A good biosecurity program must be in place to prevent the introduction of disease organisms into the chicken flock.

#### *Farm location/construction*

- It is best to build the farm in an isolated area, at least 3.2 km (2 miles) distance from the nearest poultry or other livestock facilities that may contaminate the farm.
- Build the farm away from major roadways that may be used to transport poultry.
- Fence the perimeter of the farm to prevent unwanted visitors.
- Test the water source for mineral, bacterial and chemical contamination on a regular basis as water table/aquifers can change due to season, weather and agricultural activity.
- The design and construction of the houses should prevent wild birds and rodent from entering the building. A concrete foundation and floor will prevent rodents from burrowing into the house and allow for easier removal of pathogens.
- Conventional broiler breeder houses should ideally be facing in an east-west direction.
- Clear and level an area 15 m (50 ft) around all houses so that grass can be cut quickly and easily. Gravel or pebbles are easier to maintain than grass.

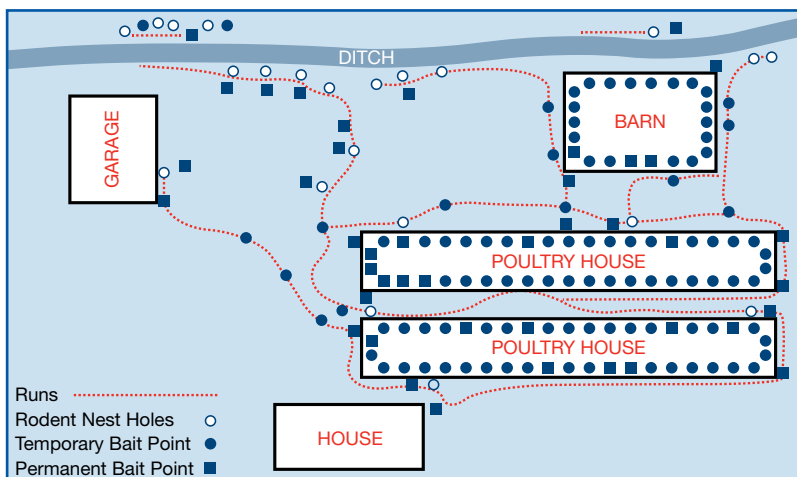
#### *Preventing diseases transmitted by humans*

- Minimize the number of visitors and prevent unauthorized access to the farm by locking the entry gates and posting no trespassing/no visitors signs.
- All people entering the farm should follow a biosecurity procedure. The requirement that all workers and visitors shower and use clean farm clothes is the best way to prevent cross contamination between facilities.
- Maintain a record of visitors, including name, company, purpose of visit, previous farm visited and next farm to be visited.
- When entering and leaving each poultry house, workers and visitors must wash and sanitize their hands and boots.
- Tools and equipment carried into the house are a potential source of disease. Only necessary items should be taken into the house and only after they have been properly cleaned and disinfected.
- If supervisory personnel are not able to avoid visiting more than one farm per day, they should visit the youngest flocks first. If an infectious disease is suspected, all visits should be stopped immediately.

#### *Preventing diseases transmitted by animals*

- Whenever possible, place the farm on an “all in/all out” placement cycle. Multiple-age chickens on the same site provide a reservoir for disease organisms.
- Downtime between flocks will reduce contamination of the farm. Downtime is defined as the time between completion of the cleaning/disinfection process and placing the next flock. A minimum downtime of 3 weeks between flocks is recommended, but the exact downtime required will depend on the size of the farm (a bigger farm may take longer to clean/disinfect).
- Keep all vegetation cut 15 m (50 ft) away from the buildings to provide an entry barrier to rodents and wild animals.
- Do not leave equipment, building materials or litter lying around. This will reduce cover for rodents and wild animals.
- Clean up feed spills as soon as they occur.
- Store litter material in bags or inside a storage building or bin.
- Keep wild birds out of all buildings.
- Maintain an effective rodent control program (**Figure 125**). Baiting programs are most effective when followed continuously.
- Where appropriate, additional anti-rodent barriers in the form of electric rodent fence or metal/concrete fence could be established around farm/house.
- Use an integrated pest management program, including mechanical, biological, and chemical controls.

**Figure 125:** Example of a rodent baiting plan. The actual number of baiting points placed must be appropriate to the risk.



### Site Cleaning

Site cleaning must clean and disinfect the poultry house, all equipment, service areas and surroundings so that all potential poultry and human pathogens are removed and the numbers of residual bacteria, viruses, parasites and insects minimized between flocks. This will minimize any effect on health, welfare and performance on the subsequent flock.

### House design

The house and equipment should be designed to enable easy, effective cleaning. Ideally, the poultry house should have concrete floors, washable (i.e. impervious) walls and ceilings, accessible ventilation ducts and no internal pillars or ledges. Earth floors are virtually impossible to clean and disinfect adequately. An area of concrete or gravel extending to a width of 1-3 m (3-10 ft) surrounding the house can discourage the entry of rodents and provide an area for washing and storing removable items of equipment.

### Procedures

**Planning:** A successful cleanout requires that all operations are effectively carried out on time. Cleanout is an opportunity to carry out routine and/or preventative maintenance on the farm and this should be planned into the cleaning and disinfection program. A plan detailing dates, times, labor, and equipment requirements should be drawn up prior to depleting the farm. This will ensure that all tasks can be completed successfully.

**Insect Control:** Insects are vectors of disease and must be destroyed before they migrate into woodwork or other materials. As soon as the flock has been removed from the house and while it is still warm, the litter, equipment, and all surfaces should be sprayed with a locally recommended insecticide. Alternatively, the house may be treated with an approved insecticide within 2 weeks prior to depletion. A second treatment with insecticide should be completed before fumigation.

**Remove dust:** All dust, debris and cobwebs must be removed from fan shafts, beams, and exposed areas of unrolled curtains in open-sided houses, ledges and stonework. For best results, use a brush so that the dust falls onto the litter.

**Pre-spray:** A knapsack or low-pressure sprayer should be used to spray a detergent solution throughout the inside of the house, from ceiling to floor, to dampen down dust before litter and equipment are removed. In open-sided houses, the curtains should be closed first.

**Remove equipment:** All equipment and fittings (drinkers, feeders, perches, nest-boxes, dividing pens, etc.) should be removed from the building and placed on the external concrete area. It may not be desirable to remove automatic nest boxes and alternative strategies may be required.

**Remove litter:** All litter and debris must be removed from within the house. Trailers or rubbish skips (dumpsters) should be placed inside the house and filled with soiled litter. The full trailer or dumpster should be covered before removal to prevent dust and debris blowing around outside. Vehicle wheels must be brushed and disinfected with spray upon leaving the house.

**Litter disposal:** Litter must not be stored on the farm or spread on land adjacent to the farm. It must be removed to a distance of at least 3.2 km (2 miles) from the farm, and disposed of in accordance with local government regulations in one of the following ways:

- Spread on arable crop land and plowed within 1 week.
- Buried in an approved landfill site, quarry or hole in the ground (in some areas this is not allowed).
- Stacked and allowed to heat (i.e. compost) for at least 1 month before being spread on livestock grazing land.
- Incinerated (in some areas this is not allowed).
- Burning litter as a biofuel for electricity production.

**Washing:** Before washing starts, check that all electricity in the house has been switched off. A pressure washer with foam detergent should be used to remove the remaining dirt and debris from the house and equipment. Many different industrial detergents are available and manufacturer's instructions should always be followed. The detergent used must be compatible with the disinfectant that will be used to disinfect the house later on. After washing with detergent, rinse the house and equipment with clean fresh water, again using a pressure washer. Hot water should be used for cleaning and excess floor water removed using a squeegee (a rubber-edged blade set on a handle, typically used for cleaning windows). Wastewater should be disposed of hygienically to avoid any re-contamination of the houses. All equipment removed from the house must also be soaked, washed and rinsed. Cleaned equipment should then be stored under cover.

Inside the house, particular attention should be paid to the following places:

- Fan boxes.
- Fan shafts.
- Fans.
- Ventilation grills.
- Tops of beams.
- Ledges.
- Water pipes.
- Feed lines.

In order to ensure that inaccessible areas are properly washed, it is recommended that portable scaffolding and portable lights are used. The outside of the building must also be washed and special attention given to:

- Air inlets.
- Gutters.
- Concrete pathways.

In open-sided housing, the inside and outside of curtains must be washed. Any items that cannot be washed (e.g. polythene, cardboard) must be destroyed.

When washing is complete, there should be no dirt, dust, debris, or litter present. Proper washing requires time and attention to detail.

Staff facilities should also be thoroughly cleaned at this stage. The egg store should be washed out and disinfected and humidifiers dismantled, serviced and cleaned prior to disinfection.

### ***Cleaning water and feed systems***

All equipment within the house must be thoroughly cleansed and disinfected. After cleansing, it is essential that the equipment is stored under cover. The procedure for cleaning the water system is as follows:

- Drain pipes and header tanks.
- Flush lines with clean water.
- Scrub header tanks to remove scale and biofilm deposit and drain to the exterior of the house.
- Refill tank with fresh water and add an approved water sanitizer.
- Run the sanitizer solution through the drinker lines from the header tank ensuring there are no air locks. Make sure the sanitizer is approved for use with the drinker equipment and is used at the correct dilution.
- Make up header tank to normal operating level with additional sanitizer solution at appropriate strength. Replace lid. Allow disinfectant to remain for a minimum of 4 hours.
- Drain and rinse with fresh water.
- Refill with fresh water prior to chick arrival.

Biofilms will form inside water pipes and regular treatment to remove them is needed to prevent decreased water flow and bacterial contamination of drinking water. Pipe material will influence the rate of biofilm formation. For example, biofilm tends to form quicker on alkathene (plastic) pipes and plastic tanks. The use of vitamin and mineral treatments in drinking water can increase biofilm and aggregation of materials to the pipes etc. Physical cleaning of the inside of pipes to remove biofilms is not always possible; therefore between flocks biofilms can be removed by using peroxygen compounds. These need to be flushed completely from the drinking system before birds drink. Cleaning may need to include acid scrubbing where the water mineral content (especially calcium or iron) is high. Metal pipes can be cleaned the same way but corrosion can cause leaks. Water treatment before use should be considered for high mineral waters.

Evaporative cooling and fogging systems can be sanitized at cleanout using a bi-guanide sanitizer. Bi-guanides can also be used during production to ensure that the water used in these systems contains minimal bacteria, reducing bacterial spread into the poultry house.

The procedure for cleaning the feed system is as follows:

- Empty, wash and disinfect all feeding equipment (e.g. feed bins, track, chain, hanging feeders).
- Empty bulk bins and connecting pipes and brush out where possible. Clean out and seal all openings.
- Fumigate wherever possible.

### **Repairs and maintenance**

A clean, empty house provides the ideal opportunity for structural repairs and maintenance to be completed. Once the house is empty, pay attention to the following tasks:

- Repair cracks in the floor with concrete/cement.
- Repair pointing (mortar joints) and cement rendering on wall structures.
- Repair or replace damaged walls, curtains and roof/ceilings.
- Carry out painting or whitewashing where required.
- Ensure that all doors shut tightly.

### **Disinfection**

Disinfection should not take place until the whole building (including the external area) is thoroughly cleaned and dried and all repairs complete. Disinfectants are ineffective in the presence of dirt and organic matter.

Disinfectants, which are approved by regulatory agencies for use against specific poultry pathogens of both bacterial and viral origin, are most likely to be effective. Manufacturers' instructions must be followed at all times.

Disinfectant should be applied using either a pressure-washer or a backpack sprayer. Foam disinfectants allow greater contact time, increasing the efficiency of disinfection. Heating houses to high temperatures after sealing can enhance disinfection.

Most disinfectants are not effective against sporulated coccidial oocysts. However, where there is a need to treat the environment to try to remove a background challenge of oocysts, there are some other treatments that can be used although these are not always effective either. For concrete floors, the use of flaming, salt or specific disinfectants that are based on phenolic compounds can be beneficial. For earth floors, salt can also be used. Ammonia is very effective against coccidial oocysts, but in most parts of the world the use of ammonia is prohibited because of the concerns about health and safety.

### **Formalin fumigation**

Where formalin fumigation is permitted, fumigation should be undertaken as soon as possible after disinfection has been completed. Surfaces should be damp and the houses warmed to a minimum of 21°C (69.8°F). Fumigation is ineffective at lower temperatures and at relative humidities of less than 65%.

Doors, fans, ventilation grills and windows must be sealed. Manufacturers' instructions concerning the use of fumigants must be followed. After fumigation, the house must remain sealed for 24 hours with NO ENTRY signs clearly displayed. The house must be thoroughly ventilated before anyone enters.

After clean litter has been spread, all the fumigation procedures described above should be repeated.

Fumigation is hazardous to animals and humans and is not permitted in all countries. Where it is permitted it must be conducted by trained personnel following local safety legislation and guidelines. Personal welfare, and health and safety guidelines must also be followed, and protective clothing (i.e. respirators, eye shields and gloves) must be worn. At least 2 people must be present in case of emergency.

In some situations, it may be necessary to use floor treatments as well. Some common floor treatments, their doses and indications are given in **Table 28**.

**Table 28:** Common floor treatments for poultry houses.

Compound	Application Rate		Purpose
	kg/m <sup>2</sup>	lbs/100 ft <sup>2</sup>	
Boric acid	As necessary	As necessary	Kills darkling beetles
Salt (NaCl)	0.25	5	Reduction of clostridium counts
Sulphur powder	0.01	2	Lowers pH
Lime (calcium oxide/hydroxide)	As necessary	As necessary	Disinfection

**Cleaning external areas**

It is vital that external areas are also cleaned thoroughly. Ideally, poultry houses should be surrounded by an area of concrete or gravel, 1-3 m (3-10 ft) in width. Where this does not exist, the area around the house must:

- Be free of vegetation.
- Be free of unused machinery/equipment.
- Have an even, level surface.
- Be well drained and free of any standing water.

Particular attention should be paid to cleaning and disinfection of the following areas:

- Under ventilator and extractor fans.
- Under the feed bins.
- Access routes.
- Door surrounds.

All concrete areas should be washed and disinfected as thoroughly as the inside of the building.

**Evaluation of farm cleaning and disinfection efficiency**

It is essential to monitor the efficiency and cost of cleaning out and disinfection. The effectiveness of cleaning is commonly evaluated by completing Salmonella isolations. Total viable bacterial counts (TVC) may also be useful. Monitoring trends in Salmonella /TVCs will allow continuous improvement in farm hygiene and comparisons to different cleaning and disinfection methods to be made.

When disinfection has been carried out effectively, the sampling procedure should not isolate any Salmonella species. For a detailed description of where to sample, and recommendations of how many samples to take, please consult your Aviagen veterinarian.



- A clear and implemented program of hygiene management should be in place for site biosecurity, and site cleaning and disinfection.
- Adequate biosecurity should prevent disease from entering the farm via both humans and animals.
- Site cleaning and disinfection must cover both the interior and exterior of the house, all equipment and external house areas, as well as the feeding and drinking systems.
- Reduce pathogen carryover by allowing adequate downtime between flocks for cleaning.
- Appropriate planning and evaluation of the cleaning and disinfection procedures must be in place.



## Water Quality

Water should be clear with no organic or suspended matter. It should be monitored to ensure purity and freedom from pathogens. Specifically, water should be free from *Pseudomonas* species and *E. coli*. There should be no more than 1 coliform/ml in any one sample and consecutive water samples must not contain coliforms in more than 5% of samples taken.

Water quality criteria for poultry are given in **Table 29**. If water comes from a main supply, there are usually less water quality issues. Water from wells however, may have excessive nitrate levels and high bacterial counts due to run-off from fertilized fields. Where bacterial counts are high, the cause should be established and rectified as soon as possible. Chlorination to give between 3 and 5 ppm free chlorine at the drinker level is usually effective in controlling bacteria but this is dependent on the type of chlorine component used.

Ultraviolet light (applied at the point of entry to the house) can also be used to disinfect water. Manufacturers' guidelines should be followed in establishing this procedure.

Hard water or water with high levels of iron (>3 mg/L) can cause blockages in drinker valves and pipes. Sediment will also block pipes and, where this is a problem, water should be filtered using a 40-50 micron ( $\mu\text{m}$ ) filter. Water containing high levels of iron can support bacterial growth and should not be used to wash or sanitize eggs.

A total water quality test should be done at least once a year and more often if there are perceived water quality issues or performance problems. After house cleaning and prior to chick delivery, water should be sampled for bacterial contamination at the source, the storage tank and the drinker points.

It is a good idea to routinely complete a visual check of the water supply to a flock. This is done by running a sample of water out of the end of each nipple line and making a visual check for clarity. If water lines and water sanitation are not adequate, there will be a high level of particulate matter in the water, visible to the naked eye. Action should be taken to rectify this issue.

Use of an approved water sanitizer on a routine basis through the flock life is also recommended. Measuring the oxidation reduction potential (ORP) of water is a good way of determining if the water sanitation program is working (**Figure 126**). An ideal ORP reading should be between 700 and 800 mV.

**Figure 126:** An example of an ORP meter.



It is also good practice to disinfect water lines once a month during the life of the flock and flush them a minimum of once a week to maintain good water quality.

**Table 29:** Water quality criteria for poultry.

Criteria	Concentration (ppm)	Comments
Total Dissolved	0-1000	Good
Solids (TDS)	1000-3000	Satisfactory: Wet droppings may result at the upper limit
	3000-5000	Poor: Wet droppings, reduced water intake, poor growth and increased mortality
	>5000	Unsatisfactory
Hardness	<100 Soft	Good: No problems
	>100 Hard	Satisfactory: No problem for poultry but can interfere with effectiveness of soap and many disinfectants and medications administered via water
pH	<6	Poor: Performance problem, corrosion of water system
	6.0-6.4	Poor: Potential problems
	6.5-8.5	Satisfactory: Recommended for poultry
	>8.6	Unsatisfactory
Sulfates	50-200	Satisfactory: May have a laxative effect if Na or Mg >50 ppm
	200-250	Maximum desirable level
	250-500	May have a laxative effect
	500-1000	Poor: Laxative effect but birds may adjust, may interfere with copper absorption, additive laxative effect with chlorides
	>1000	Unsatisfactory: Increases water intake and wet droppings, health hazard for the young birds
Chloride	250	Satisfactory: Highest desirable level, levels as low as 14 ppm may cause problems if sodium is higher than 50 ppm
	500	Maximum desirable level
	>500	Unsatisfactory: Laxative effect, wet droppings, reduces feed intake, increases water intake
Potassium	<300	Good: No problems
	>300	Satisfactory: Depends upon the alkalinity and pH
Magnesium	50-125	Satisfactory: If sulfate level >50ppm magnesium sulfate (laxative) will form
	>125	Laxative effect with intestinal irritation
	350	Maximum
Nitrate Nitrogen	10	Maximum (sometimes levels of 3 mg/L will affect performance)
Nitrates	trace	Satisfactory
	>trace	Unsatisfactory: Health hazard (indicates organic material fecal contamination)
Iron	<0.3	Satisfactory
	>0.3	Unsatisfactory: Growth of iron bacteria (clogs water system and bad odor)
Fluoride	2	Maximum
	>40	Unsatisfactory: Causes soft bones
Bacterial Coliforms	0 cfu/ml	Ideal: Levels above indicates fecal contaminations
Calcium	600	Maximum level
Sodium	50-300	Satisfactory: Generally no problem, however may cause loose droppings if sulfates >50 ppm or if chloride >14 ppm

Note: 1 ppm approximates to 1 mg.



- Good water quality is essential for bird health and welfare.
- Water quality should be routinely tested for bacterial and mineral contamination, and necessary corrective action taken based on the test results.

## Dead Bird Disposal

**Table 30:** Advantages and disadvantages of common methods of dead bird disposal.

Method	Advantages	Disadvantages
Disposal Pits	Inexpensive to dig and tends to produce a low odor.	Can be a reservoir for diseases and requires adequate drainage.
Incineration	Does not contaminate ground water or produce cross-contamination with other birds when facilities are properly maintained.  Little by-product to remove from the farm.	Tends to be more expensive and may produce air pollution.  Must ensure that there is sufficient capacity for future farm needs.  Must ensure that carcasses are burned completely to white ash.
Composting	Economical and if designed and managed properly, will not contaminate ground water or air.	If not done to the correct temperature, live viable diseases may be present on the farm.
Rendering	There is no on-farm disposal of dead birds.  Requires minimal capital investment.  Produces minimal environmental contamination.  Materials can be turned into feed ingredients for other appropriate livestock.	Requires freezers to keep birds from decomposing during storage.  Requires intense biosecurity measures to ensure that personnel do not transfer diseases from the rendering plant to the farm.



- Dead birds should be disposed of in a manner that avoids contamination of the environment, prevents cross-contamination with other poultry, is not a nuisance to neighbors and is in accordance with local legislation.

## Health Management

### Disease Control

Good management practices and high standards of biosecurity will prevent many poultry diseases. One of the first signs of a disease challenge is a decrease in water or feed intake (i.e. increased feed clean-up time). It is, therefore, good management practice to keep daily records of feed and water consumption. If a problem is suspected, immediate action should be taken by sending birds for post mortem examination and contacting the flock veterinary adviser. Early appropriate treatment of a disease incident may minimize the adverse effects on the birds' health, welfare, and reproductive performance and also minimize the effects on the health, welfare, and quality of the progeny.

Records are an important means of providing objective data for the investigation of flock problems. Vaccinations, route of application, batch numbers, medications, observations, and disease investigation results should all be recorded in flock diaries.

### Vaccination

Vaccination provides the bird with exposure to a particular form of the infectious organism (antigen) to promote a good immunological response. This will actively protect the bird from subsequent field challenge and/or provide passive protection, via maternally derived antibodies, to the progeny.

### Vaccination programs

Common diseases, including Marek's Disease (MDV), Newcastle Disease (ND), Avian Encephalomyelitis (AE), Infectious Bronchitis (IB), Infectious Bursal Disease (IBD) (i.e. Gumboro Disease) and Chicken Anemia Virus (CAV) amongst others, should be routinely considered when a vaccination program is prepared. However, vaccination requirements will vary depending on local challenges, vaccine availability and local regulations. A suitable program should be devised by local flock veterinary advisers, who will use their detailed knowledge of the disease prevalence and intensity in a specific country, area or site.

Dyes, vaccine titers, and the elimination of clinical signs of disease can be used to assess the effectiveness of vaccines and vaccine delivery. It should be noted that titres are not always correlated with protection but are still useful when trying to evaluate the vaccination program. Excessive vaccination may lead to poor titers and/or coefficient of variation (CVs) of titers. Overly aggressive vaccination programs can also impact growing chickens, especially from 10-15 weeks of age (so try to minimize bird handlings when possible). The field situation should also be considered in evaluating the effectiveness of a vaccination program. Hygiene and maintenance of vaccination equipment are important, and it is important to follow the manufacturer's vaccine instructions on methods of administration to get optimum results.

Vaccination can help prevent disease but is not a direct replacement for good biosecurity. Protection against each individual disease should be assessed when devising a suitable control strategy. For instance, "all in/all out" policies provide good protection against Fowl Coryza and Infectious Laryngotracheitis (ILT), so that vaccination is unnecessary in some instances. The vaccines used in the vaccination program should be limited to those that are absolutely necessary as this will reduce costs, have less impact on the birds, and provide greater opportunity to maximize the overall vaccine response. Vaccines should be obtained from reputable manufacturers only.

### Types of vaccine

Vaccines for poultry are in 2 basic forms, killed (inactivated) and live. In some vaccination programs, they may be combined to promote maximum immunological response. Each type of vaccine has specific uses and advantages.

*Killed Vaccines:* These are composed of inactivated organisms (antigens), usually combined with an oil emulsion or aluminium hydroxide adjuvant. The adjuvant helps increase the response to an antigen by the bird's immune system over a longer period of time. Killed vaccines may contain multiple inactivated antigens to several poultry diseases. Killed vaccines are administered to individual birds by injection either subcutaneously or intramuscularly.

*Live Vaccines:* These consist of infectious organisms of the actual poultry disease. However, the organisms will have been substantially modified (attenuated) so that when they multiply within the bird they do not cause disease but do promote an immune response. Some vaccines are exceptional in that they are not attenuated and therefore require care before introduction into a vaccination program (e.g. some Coccidiosis vaccines).

In principle, when several live vaccinations are given for a specific disease, the most attenuated form of the vaccine is normally given first, followed by a less attenuated form where available. This principle is commonly utilized for ND live vaccination when pathogenic field challenge is anticipated.

Attenuated live vaccines are usually administered to the flock via drinking water, spray, and eye drop application or wing-web application. Occasionally, live vaccinations are given by injection (e.g. Mareks Disease vaccine.)

Live bacterial vaccines for Salmonella and Mycoplasma are now available and may have a place in some production systems. Some competitive exclusion products (products consisting of healthy bacteria normally found in the gastrointestinal tract, which help to minimize colonization of undesirable harmful bacteria such as Salmonella) can also have a place in protecting parent stock from Salmonella and possibly other infections early in life, or after antibiotic treatment.

**Combined live and killed vaccinations**

The most effective method of achieving high and uniform levels of antibody to a disease is by the use of one or more live vaccines containing the specific antigen, followed by injection of the killed antigen. The live vaccines prime the bird’s immune system and facilitate a very good antibody response when the killed antigen is presented. This type of vaccination program is used routinely for many diseases such as IB, IBD (Gumboro), Reovirus (Reo) and ND. It ensures active protection of the bird and provision of high and uniform levels of maternally derived antibody. This allows passive protection of the progeny.

**Specific vaccination programs**

Vaccination programs must be designed according to local disease challenges and maternal antibody requirements in broilers. A suitable vaccination program should be established by the local veterinarian responsible for the health status of the operation. Veterinarians are available to provide suggestions or supportive information. **Table 31** below gives some essential factors for the successful vaccination of parent stock.

**Table 31:** Factors for a successful vaccination program.

Vaccination Program(s) Design	Vaccine Administration	Vaccine Effectiveness
<p>Programs must be based on veterinary advice tailored to specific local and regional challenges established by health surveys and laboratory analysis.</p> <p>Carefully select single or combined vaccines according to age and health status of flocks.</p> <p>Vaccination must result in the development of consistent levels of immunity while minimizing potential adverse effects.</p> <p>Breeder programs should provide adequate and uniform levels of maternal antibodies to protect chicks against several viral diseases during the first weeks of life.</p> <p>Maternal antibodies may interfere with the chick's response to some vaccine strains. Levels of maternal antibodies in broilers will decline as the breeder source flock ages.</p>	<p>Follow manufacturer recommendations for product handling and method of administration.</p> <p>Properly train vaccine administrators to handle and administer vaccines.</p> <p>Maintain vaccination records.</p> <p>When live vaccines are given in chlorinated water, stop chlorination a minimum of 24 hours prior to vaccination. Chlorine can reduce vaccine titer or cause inactivation.</p>	<p>Seek veterinary advice prior to vaccinating sick or distressed birds.</p> <p>Periodic and efficient house cleaning followed by placement of new litter material reduces the concentration of pathogens in the environment.</p> <p>Adequate downtime between flocks helps to reduce the build-up of normal house pathogens that can affect flock performance.</p> <p>Regular audits of vaccine handling, administration techniques and post-vaccinal responses are critical to control challenges and improve performance.</p> <p>Ventilation and management should be optimized post-vaccination, especially during times of vaccine-induced reaction.</p>

**Marek's Disease virus**

All broiler parent stock should receive Marek's Disease vaccine at day-old or *in ovo* at the hatchery. There are three different serotypes of live Marek's vaccine available. Which vaccine (s) should be administered is dependent on the level of challenge in an area. The two most common serotypes are HVT (Turkey Herpes Virus), which is a serotype 3 and Rispen's, which is a serotype 1. Rispen's is usually used in any high challenge areas, often in combination with other MDV vaccine serotypes. Combinations of different Marek's serotypes are often given for best protection depending on the challenge in the area the birds are to be placed.

**Coccidiosis**

Control of coccidiosis is important in broiler breeders. Vaccination of parent stock with live coccidiosis vaccines at the hatchery is now the method of choice for controlling this condition. In some cases birds are vaccinated on farm. Care should be taken to prevent subsequent exposure of the flock to substances with anticoccidial activity (except where recommended by the vaccine manufacturer). Post-vaccination management ensuring oocyst sporulation and re-infection is necessary to improve vaccine efficiency. Birds should be monitored by routine necropsies at specific ages (depending on the vaccine) to monitor for excessive reaction. Controlling vaccine reactions through good management and vaccine application is very important for good bird performance. Coccidiosis can also be controlled by the use of in-feed anticoccidial drugs. The use of OPG (oocysts per gram) counts from fecal sampling can also be useful in monitoring the effectiveness of a cocci vaccination program.

**Worm (helminth) control**

It is important to monitor and control the internal worm burden (Helminth parasites) to which birds are exposed. A common program is for birds to receive 2-5 doses of an anthelmintic drug treatment during the rearing period where required. Monitoring the efficiency of the control program through routine post mortem examination of birds can determine the necessity for any additional anthelmintic treatments. Many anthelmintics should not be used when birds are in production as they might have negative effects on egg production and/or egg quality and fertility.

**Salmonella and feed hygiene**

Salmonella infection through contaminated feed represents a major threat to bird health. The risk of contaminated feed can be minimized by thermal processing of the feed and/or addition of feed additives with antimicrobial activity. Monitoring of raw materials will provide information about the degree of challenge coming through the ingredients into the diets.

Raw materials of animal origin and processed vegetable proteins are at high risk of salmonella contamination and their source and use in feeds for parent stock should be considered carefully.

Thermal processing of feed (e.g. conditioning, extending, pelleting) is used frequently to reduce bacterial contamination. An ideal goal is less than 10 enterobacteriaceae per gram of feed.

**Antibiotics**

Antibiotic administration must be for therapeutic use only, as a tool to treat infections, avoid pain and suffering, and preserve the welfare of the flocks. Antibiotics should be used only under the direct supervision of a veterinarian and records of all prescriptions should be kept.



- Good management and biosecurity will prevent many poultry diseases.
- Monitor feed and water intake for the first signs of a disease challenge.
- Respond promptly to any signs of a disease challenge by completing post-mortem examinations and contacting the local veterinarian.
- Vaccination alone cannot protect flocks against overwhelming disease challenges and poor management.
- Vaccination is most effective when disease challenges are minimized through well designed biosecurity and management programs.
- Vaccination should be based on local disease challenges and availability of vaccine.
- Monitor and control worm burden.
- Salmonella infection via feed is a threat to bird health. Heat treatment and monitoring of raw materials will minimize the risk of contamination.
- Only use antibiotics to treat disease and with veterinary supervision.
- Keep records and monitor flock health.



## Health Monitoring Programs

Health monitoring programs have two purposes:

1. To confirm freedom from specific pathogens that can adversely affect the health, welfare and performance of parent stock and the health, welfare and quality of the progeny (broilers).
2. To identify the presence of disease at an early stage so that corrective measures can be implemented to minimize adverse effects either to the flock or the progeny.

Routine necropsy of mortality and regular laboratory monitoring of the flock will help develop an understanding of the flock's health status. When health problems are seen or suspected, veterinary advice should be sought immediately.

It is important to keep up-to-date with local and regional health concerns and be aware of any potential disease challenges.

### Salmonella

*Salmonella pullorum* and *S. gallinarum* are strains that are specific to poultry. Control is monitored by detecting the presence of specific antibodies in blood using an agglutination test. This test can be conducted either on the farm using whole blood or in the laboratory using serum. Many countries have official programs for the control and eradication of both *S. pullorum* and *S. gallinarum*. Both commercial and government supplies of a specific antigen are available in many countries. The absence of these infections can also be monitored by microbiological surveys of the progeny and hatcheries. The presence of *Salmonellae* is usually detected by bacteriological examination of the bird, the environment and the product as it proceeds through the hatchery. Many *Salmonellae* can affect both birds and humans (zoonosis). *S. Enteritidis* and *S. typhimurium* are of particular importance and can readily be transmitted vertically to the broiler progeny. However, specific commercial ELISA tests for *S. Enteritidis* and *S. typhimurium* are available and can be used in a similar manner to the agglutination test for *S. pullorum* and *S. gallinarum* to detect specific antibodies in serum. Cull birds, cloacal swabs, fresh cecal droppings, litter, drag swabs/shoe covers and dust samples have all been used to monitor flocks for the presence of *Salmonellae*. Hatchery samples include dead-in-shell, cull chicks, hatcher tray papers (where available), chick box liners and hatchery fluff. Samples can be pooled, usually in tens, to facilitate practical processing through the laboratory. Many countries have official programs that include detailed detection methods and schedules for *Salmonellae* monitoring and eradication in poultry flocks.

### Mycoplasma

Blood samples taken from parent flocks should be monitored routinely for both *Mycoplasma gallisepticum* and *Mycoplasma synoviae* using the rapid serum agglutination test (RSAT) or specific, single or combined commercial Enzyme Linked Immunosorbent Assay (ELISA) tests. Confirmation can be conducted by PCR and/or culture. It should be noted that it is possible to get some false positive results with RSAT and ELISA tests, especially when monitoring day-old chicks.

### Other Diseases

Serological monitoring for the presence of other diseases can be carried out routinely or as is more common, following clinical signs and/or a drop in production. Serological monitoring for diagnostic purposes can include those diseases for which flocks have been previously vaccinated (e.g. ND, IB). Field challenge is suggested when a higher antibody response than normal has occurred in the flock.

### Sampling for the Presence of Disease

Monitoring for most diseases in a population should be designed to detect a prevalence of at least 5%, with a 95% confidence. For those population sizes that normally apply to broiler parent flocks (i.e. >500 birds), approximately 60 samples should be taken when monitoring each flock. Traditionally, a higher level of monitoring is carried out prior to the onset of egg production at 140-154 days (20-22 weeks) of age, especially for *Mycoplasmas* and *Salmonellae* in parent flocks. Usually 10% or a minimum of 100 samples are tested at this critical time. The frequency of testing will vary with the individual disease and the requirements of local trading.

Certification of freedom from specific avian pathogens is required when products from a flock, either eggs or day-old chicks, are traded between countries. The specific health requirements will vary from country to country.

### Monitoring the Effectiveness of Vaccination Programs

Vaccination programs provide both active protection to the birds and passive protection to the progeny by the provision of high, uniform levels of maternally derived antibody. Monitoring of vaccination programs is important and can be achieved by measuring the level of specific antibody in individual birds and by assessing the range of response in the number of birds sampled. Usually, a minimum of 20 blood samples per group are used and various quantitative serological tests have been used to quantify antibody response in vaccinated flocks. These tests include the haemagglutination inhibition (HI) test, agar gel diffusion (AGD) test, or the ELISA test. The ELISA test is considered to be specific, sensitive and repeatable, and can be automated to enhance the efficiency of serological testing in a laboratory.

Serological evaluation should be scheduled around the vaccination program so a local database is developed. If changes occur in the vaccination program, the monitoring program might also need to be changed accordingly. Each operation must develop its own baseline to facilitate interpretation of results.

Routine testing after killed vaccination (around point of lay) can allow the maternal antibody to be predicted for the total period of lay. Cross-reactions in mycoplasma serology are commonly seen in birds for a 2-week period after the use of killed vaccines, so sampling around this time should be avoided.

### Documentation and Records

Records should be maintained for auditing and traceability. They should be clear, legible, and detailed enough to allow investigation into possible causes of poor quality, poor performance, morbidity, and mortality. Records may also be used as checklist by staff to ensure tasks are carried out.



- The effectiveness of the health and biosecurity programs in place must be routinely monitored and clear and detailed records must be in place.
- Appropriate corrective action must be taken if health monitoring procedures are found to be inadequate.

## Appendices

### Appendix 1: Records

Record keeping, data analysis and interpretation are essential aids to effective management. Record keeping should be used in conjunction with target performance parameters. Records required to be kept are as follows:

#### REARING

- Breed
- Source flock
- Hatch date
- Number of birds housed (male and female)
- Floor area and stocking density
- Feeder space per bird
- Drinker space per bird
- Feed/bird - daily, weekly and cumulative
- Mortality and culls - daily, weekly and cumulative
- Body weights, average body-weight gain, CV%/uniformity and age of recording (male and female) - daily/weekly
- External and internal temperatures - minimum and maximum and operating (internal only)
- Water consumption - daily
- Water:feed ratio
- Sexing errors

#### LAYING

- Breed
- Source flock
- Hatch date/date of housing
- Number of birds housed (male and female)
- Floor area and stocking density
- Mating ratio
- Eggs produced - daily, weekly, cumulative per bird
- Hatching egg number - daily, weekly, cumulative
- Floor eggs - daily, weekly and cumulative
- Feed - daily and cumulative
- Clean-up time
- Body weights, CV%/uniformity and average body-weight gain (male and female) - daily/weekly
- Average egg weight - daily and weekly
- Egg Mass - daily and weekly
- Mortality and culls - daily, weekly and cumulative
- Hatchability
- Fertility
- External and internal temperatures - minimum and maximum and operating (internal only)
- Water consumption - daily
- Water:feed ratio
- Humidity
- Hours of light

### **TREATMENTS AND SIGNIFICANT EVENTS**

Lighting program  
Feed deliveries  
Vaccination - date, dosage and batch number  
Medications - date, dosage and veterinary prescription  
Disease - type, date and number of birds affected  
Veterinary consultations - date and recommendations  
Cleaning and disinfection - materials and methods  
Bacterial counts after cleaning out (TVC)  
Incidents - equipment malfunction etc.

### **TARGET PARAMETERS**

Weekly body weight and average body-weight gain - male and female  
Egg production - number and weight  
Hatching egg production  
Hatchability and fertility  
Weekly egg weight and egg mass

### **RECORDING SYSTEM**

All essential records should be recorded in an appropriate recording system, which allows easy data recording, analysis and interpretation. Comprehensive data recording systems are freely available from Aviagen.

## Appendix 2: Useful Management Information

STOCKING DENSITIES	
Rearing 0-140 Days (0-20 Weeks)	
Males Birds/m <sup>2</sup> (ft <sup>2</sup> /bird)	Females Birds/m <sup>2</sup> (ft <sup>2</sup> /bird)
3-4 (2.7-3.6)	4-8 (1.4-2.7)
Production 140-448 Days (20-64 Weeks)	
Males and Females Birds/m <sup>2</sup> (ft <sup>2</sup> /bird)	
3.5-5.5 (2.0-3.1)	

FEEDER SPACE PER BIRD		
Males Age	Track cm (in)	Pan cm (in)
0-35 days (0-5 weeks)	5 (2)	5 (2)
36-70 days (5-10 weeks)	10 (4)	9 (3.5)
71 - 140 days (10-20 weeks)	15 (6)	11 (4)
141 days - depletion (20 weeks – depletion)	20 (8)	13 (5)
Females Age	Track cm (in)	Pan cm (in)
0-35 days (0-5 weeks)	5 (2)	5 (2)
36-70 days (5-10 weeks)	10 (4)	8 (3)
71 days - depletion (10 weeks - depletion)	15 (6)	10 (4)

DRINKER SPACE		
	Rearing Period (0-15 Weeks)	Production Period (16 Weeks to Depletion)
Automatic circular or trough drinkers	1.5 cm (0.6 in) / bird	2.5 cm (1.0 in) / bird
Nipples	1 / 8-12 birds	1 / 6-10 birds
Cups	1 / 20-30 birds	1 / 15-20 birds

A GUIDE TO TYPICAL MATING RATIOS		
Age		Number of Males/100 Females (22 Weeks to Depletion)
Days	Weeks	
154-168	22-24	9.50-10.00
168-210	24-30	9.00-10.00
210-245	30-35	8.50-9.75
245-280	35-40	8.00-9.50
280-350	40-50	7.50-9.25
350-depletion	50-depletion	7.00-9.00



## Appendix 3: Conversion Tables

LENGTH	
1 meter (m)	= 3.281 feet (ft)
1 foot (ft)	= 0.305 meter (m)
1 centimeter (cm)	= 0.394 inch (in)
1 inch (in)	= 2.54 centimeters (cm)

AREA	
1 square meter (m <sup>2</sup> )	= 10.76 square feet (ft <sup>2</sup> )
1 square foot (ft <sup>2</sup> )	= 0.093 square meter (m <sup>2</sup> )

VOLUME	
1 liter (L)	= 0.22 gallon (gal) or 0.264 US gallons (gal US)
1 imperial gallon (gal)	= 4.54 liters (L)
1 US gallon (gal US)	= 3.79 liters (L)
1 imperial gallon (gal)	= 1.2 US gallons (gal US)
1 cubic meter (m <sup>3</sup> )	= 35.31 cubic feet (ft <sup>3</sup> )
1 cubic foot (ft <sup>3</sup> )	= 0.028 cubic meter (m <sup>3</sup> )

WEIGHT	
1 kilogram (kg)	= 2.205 pounds (lb)
1 pound (lb)	= 0.454 kilogram (kg)
1 gram (g)	= 0.035 ounce (oz)
1 ounce (oz)	= 28.35 grams (g)

ENERGY	
1 calorie (cal)	= 4.184 Joules (J)
1 Joule (J)	= 0.239 calories (cal)
1 kilocalorie per kilogram (kcal/kg)	= 4.184 Megajoules per kilogram (MJ/kg)
1 Megajoule per kilogram (MJ/kg)	= 108 calories per pound (cal/lb)
1 Joule (J)	= 0.735 foot-pound (ft-lb)
1 foot-pound (ft-lb)	= 1.36 Joules (J)
1 Joule (J)	= 0.00095 British Thermal Unit (BTU)
1 British Thermal Unit (BTU)	= 1055 Joules (J)
1 kilowatt hour (kW-h)	= 3412.1 British Thermal Unit (BTU)
1 British Thermal Unit (BTU)	= 0.00029 kilowatt hour (kW-h)

<b>PRESSURE</b>	
1 pound per square inch (psi)	= 6895 Newtons per square meter (N/m <sup>2</sup> ) or Pascals (Pa)
1 pound per square inch (psi)	= 0.06895 bar
1 bar	= 14.504 pounds per square inch (psi)
1 bar	= 104 Newtons per square meter (N/m <sup>2</sup> ) or Pascals (Pa) = 100 kilopascals (kPa)
1 Newton per square meter (N/m <sup>2</sup> ) or Pascal (Pa)	= 0.000145 pound per square inch (lb/in <sup>2</sup> )

<b>STOCKING DENSITY</b>	
1 square foot per bird (ft <sup>2</sup> /bird)	= 10.76 birds per square meter (bird/m <sup>2</sup> )
10 birds per square meter (bird/m <sup>2</sup> )	= 1.08 square feet per bird (ft <sup>2</sup> /bird)
1 kilogram per square meter (kg/m <sup>2</sup> )	= 0.205 pound per square foot (lb/ft <sup>2</sup> )
1 pound per square foot (lb/ft <sup>2</sup> )	= 4.88 kilograms per square meter (kg/m <sup>2</sup> )

<b>TEMPERATURE</b>	
Temperature (°C)	= (Temperature °F - 32) ÷ 1.8
Temperature (°F)	= 32 + (1.8 x Temperature °C)

<b>TEMPERATURE CONVERSION CHART</b>	
°C	°F
0	32.0
2	35.6
4	39.2
6	42.8
8	46.4
10	50.0
12	53.6
14	57.2
16	60.8
18	64.4
20	68.0
22	71.6
24	75.2
26	78.8
28	82.4
30	86.0
32	89.6
34	93.2
36	96.8
38	100.4
40	104.0

**OPERATING TEMPERATURE**

Operating temperature is defined as the minimum house temperature plus 2/3 of the difference between minimum and maximum house temperatures. It is important where there are significant diurnal temperature fluctuations.

e.g. Minimum house temperature = 16°C (61°F)  
 Maximum house temperature = 28°C (82°F)

Operating temperature =  $[(28-16) \times 2/3] + 16 = 24^\circ\text{C}$   
 $[(82-61) \times 2/3] + 61 = 75^\circ\text{F}$

VENTILATION	
1 cubic foot per minute (ft <sup>3</sup> /min)	= 1.699 cubic meters per hour (m <sup>3</sup> /hr)
1 cubic meter per hour (m <sup>3</sup> /hr)	= 0.589 cubic feet per minute (ft <sup>3</sup> /min)

**INSULATION**

The R value rates the isolative properties of building materials, the higher the R value the better the insulation. It is measured in square-meter kelvin per Watt (m<sup>2</sup>k/W) or square-foot-degree Fahrenheit-hour/British thermal unit (ft<sup>2</sup>·°F·hr/BTU).

The U value is the inverse of the R value and describes how well a building material conducts heat. The lower the U value the better the insulation. It is measured in Watts per meter squared kelvin (W/m<sup>2</sup>K) or British thermal unit per hour degree Fahrenheit square foot.

INSULATION	
1 square-foot-degree Fahrenheit-hour/ British thermal unit (ft <sup>2</sup> ·°F·hr/BTU)	= 5.678 square meter kelvin per Watt (m <sup>2</sup> k/W)
1 square meter kelvin per Watt (m <sup>2</sup> k/W)	= 0.176 square-foot-degree Fahrenheit-hour/British thermal unit (ft <sup>2</sup> ·°F·hr/BTU)

LIGHT	
1 foot candle	= 10.76 lux
1 lux	= 0.093 fc

# Appendix 4: Grading Calculations

## Example of Manual Calculations for Grading

If electronic scales are not available a manual weighing will need to be completed. From each pen/population a random sample of birds should be caught and weighed. All birds caught in the catching pen need to be weighed to avoid selective weighing, but as a minimum the weights of 2% of the pen/population or 50 birds, whichever is greater, need to be recorded. In this example a total of 197 birds have been weighed.

All sample weights should be recorded on a body weight recording chart such as that given below.

### Example of manual body weight recording chart for 3-way grade.

WEIGHT POUNDS	WEIGHT GRAMS	NUMBER OF BIRDS																													
		1	2	3	4	5	6	7	8	9	10	11	12	13	14	15	16	17	18	19	20	21	22	23	24	25	26	27	28	29	30
0.00	00																														
0.04	20																														
0.09	40																														
0.13	60																														
0.18	80																														
0.22	100																														
0.26	120																														
0.31	140																														
0.35	160																														
0.40	180																														
0.44	200																														
0.49	220																														
0.53	240																														
0.57	260																														
0.62	280																														
0.66	300																														
0.71	320	x	x	x	x																										
0.75	340	x	x	x	x	x	x	x																							
0.79	360	x	x	x	x	x	x	x	x	x	x																				
0.84	380	x	x	x	x	x	x	x	x	x	x	x																			
0.88	400	x	x	x	x	x	x	x	x	x	x	x	x																		
0.93	420	x	x	x	x	x	x	x	x	x	x	x	x	x																	
0.97	440	x	x	x	x	x	x	x	x	x	x	x	x	x	x																
1.01	460	x	x	x	x	x	x	x	x	x	x	x	x	x	x	x															
1.06	480	x	x	x	x	x	x	x	x	x	x	x	x	x	x	x	x														
1.10	500	x	x	x	x	x	x	x	x	x	x	x	x	x	x	x	x	x													
1.15	520	x	x	x	x	x	x	x	x	x	x	x	x	x	x	x	x	x	x												
1.19	540	x	x	x	x	x	x	x	x																						
1.23	560	x	x	x	x	x	x																								
1.28	580																														
1.32	600																														
1.37	620																														
1.41	640																														
1.46	660																														
1.50	680																														
1.54	700																														
1.59	720																														
1.63	740																														
1.68	760																														
1.72	780																														
1.76	800																														
1.81	820																														
1.85	840																														
1.90	860																														
1.94	880																														

Flock Details	kg	lbs
Age	28 days	28 days
Total Birds Weighed	197	197
Target Weight	0.450	0.99
Average Weight	0.446	0.98
Body Weight Range	0.259	0.57

### Manual 3-way Grade Using CV%

From the sample body weights in the previous chart (**Example of manual body weight recording chart for 3-way grade**), CV% for the total population can be calculated as:

$$CV\% = (\text{Standard deviation} \div \text{Average body weight}) \times 100$$

*\*standard deviation can be calculated in excel or using a scientific calculator.*

$$CV\% = (0.06 \text{ kg} \div 0.45 \text{ kg}) \times 100 = 13.3$$

$$= (0.13 \text{ lb} \div 0.98 \text{ lb}) \times 100 = 13.3$$

### Grading cut-offs when using CV% to grade.

Flock CV%	Percentage in Each Population After Grading			
	2- or 3-way grade	Light (%)	Average (%)	Heavy (%)
10-12	2-way grade	20	≈ 80 (78-82)	0
12-14	3-way grade	22-25	≈ 70 (66-73)	5-9
>14	3-way grade	28-30	≈ 58 (55-60)	12-15

The CV% is 13.5 so a 3-way grade is required. Using the information in the above table (**Grading cut-offs when using CV% to grade**) the approximate percentage of birds required in each of the three populations is 24% light birds, 69% normal and 7% heavy birds.

### Cut-off points and number of birds in each group.

	% of Birds	No. of Birds = (% birds ÷ 100) x total birds weighed
Light Birds	24	47
Average Birds	69	136
Heavy Birds	7	14

The **light** graded population will be approximately 24% of the entire flock. Of the 197 birds weighed the lightest 24% (or 47 birds) are in the weight range of 0.320 to 0.419 kg (0.71 to 0.92 lbs). A **light** bird will therefore be a bird weighing **less than or equal to 0.419 kg (0.92 lbs)**.

Using the same process the cut-off weights for the average and heavy populations can also be determined.

The **average** graded population will therefore be in the weight range of **0.420 to 0.539 kg (0.93 to 1.19 lbs)**.

The **heavy** graded population will be any bird that is **0.540 kg (1.19 lbs) or heavier**.

If a 2-way grade is required (i.e. CV% is below 12), the cut-off points provided in the table **Grading cut-off points when using CV% to grade** and the information from the the manual body weight recording chart can be used to establish the cut-off weights for a 2-way grade in the same way as was done in the example for a 3-way grade given above.

## Manual 3-way Grade Using Uniformity

Using the sample body weight information in the manual body weight recording chart given on page 174 and the grading cut-offs given in the table below, the cut-off weights for the graded populations can be determined as follows:

### Grading cut-offs when using uniformity to grade.

Uniformity	2- or 3-way Grade
65%-80%	2-way grade
65% or lower	3-way grade

Ideal body weight range assumed to be +/-10% of average sample weight.

10% of average sample weight =  $0.1 \times 0.446 \text{ kg (0.98 lbs)}$  = **0.045 kg (0.099 lbs)**

Therefore,

+10% of average weight:  $0.446 + 0.045 \text{ kg (0.98 + 0.10 lbs)}$  = **0.491 kg (1.08 lbs)**

-10% of average weight:  $0.446 - 0.045 \text{ kg (0.98 - 0.10 lbs)}$  = **0.401 kg (0.88 lbs)**

115 birds out of 197 weighed are within the weight range that is +/- 10% of the average body weight 0.401-0.491 kg (0.88-1.08 lbs). Uniformity is therefore **58%**.

As uniformity is less than 65%, a 3-way grade is required (see table above, **Grading cut-offs when using uniformity to grade**).

**Light** birds will be those that weigh **0.401 kg (0.88 lbs) or less** (-10% of the average sample weight).

**Average** birds will be those that weigh **0.402-0.491 kg (0.88-1.08 lbs)**.

**Heavy** birds will be those that weigh **0.492 kg (1.08 lbs) or heavier** (+10% of the average sample weight).

If a 2-way grade is required (i.e. flock uniformity is 65% or greater), the information from the sample weighing can be used to establish cut-off weights for the two graded populations in the same way as was done in the example for a 3-way grade given above.



### Examples of Grading When Fixed Penning is Available

Example of how to grade using CV% when fixed penning is available.

CURRENT DATA METRIC	
TOTAL WEIGHED:	197
AVERAGE WEIGHT:	0.45
DEVIATION:	0.06
C.V. (%)	<b>13.3</b>
Band limits	Total
0.320 to 0.339	4
0.340 to 0.359	7
0.360 to 0.379	10
0.380 to 0.399	12
0.400 to 0.419	16
0.420 to 0.439	14
0.440 to 0.459	27
0.460 to 0.479	30
0.480 to 0.499	28
0.500 to 0.519	22
0.520 to 0.539	13
0.540 to 0.559	8
0.560 to 0.579	6

Flock details	kg	lbs
Age	28 days	28 days
Target weight	0.450	0.99
Average weight	0.446	0.98
Total birds weighed	197	197

Based on this flock sampling data, a 3-way grade is required as CV% is between 12% and 14% (see table, **Grading cut-offs when using CV% to grade**).

In this example, there are 4 pens each of the same size. 25% of the population will need to be housed in each pen, the percentage of birds in each population will therefore be 25% light, 50% average and 25% heavy.

Cut-off points and number of birds in each group:

	% of Birds	No. of Birds = (% birds ÷ 100) x total birds weighed
Light Birds	25	49
Average Birds	50	99
Heavy Birds	25	49

CURRENT DATA IMPERIAL	
TOTAL WEIGHED:	95
AVERAGE WEIGHT:	0.98
DEVIATION:	0.13
C.V. (%)	<b>13.3</b>
Band limits	Total
0.705 to 0.747	4
0.750 to 0.791	7
0.794 to 0.836	10
0.838 to 0.880	12
0.882 to 0.924	16
0.926 to 0.968	14
0.970 to 1.012	27
1.014 to 1.056	30
1.058 to 1.100	28
1.102 to 1.144	22
1.146 to 1.188	13
1.190 to 1.232	8
1.235 to 1.276	6

The **light** graded population will be 25% of the entire flock. Of the 197 birds weighed the lightest 25% (or 49 birds) are in the weight range of 0.320 to 0.419 kg (0.71 to 0.92 lbs). A **light** bird will therefore be a bird weighing **less than or equal to 0.419 kg (0.92 lbs)**.

Using the calculation above the cut off weights for the average and heavy populations can also be determined.

The **average** graded population will be in the weight range of **0.420 to 0.499 kg (0.92 to 1.10 lbs)**.

The **heavy** graded population will be any bird that is **0.500 kg (1.10 lbs) or heavier**.

Once movement of birds into each grading pen has been completed according to recommended calculated numbers/percentages and cut-off points, an adjustment to bird numbers per pen can be made (if needed), to achieve the correct stocking densities according to actual pen sizes.

If a 2-way grade is required (i.e. flock CV% is lower than 12), the percentage of birds in each population would be 25% light and 75% average and cut-offs weights would be determined on that basis in the same way as was done for the 3-way grade example given above.

Example of how to grade using uniformity when fixed penning is available.

CURRENT DATA METRIC	
TOTAL WEIGHED:	197
AVERAGE WEIGHT:	0.45
DEVIATION:	0.06
C.V. (%)	<b>13.3</b>
Band limits	Total
0.320 to 0.339	4
0.340 to 0.359	7
0.360 to 0.379	10
0.380 to 0.399	12
0.400 to 0.419	16
0.420 to 0.439	14
0.440 to 0.459	27
0.460 to 0.479	30
0.480 to 0.499	28
0.500 to 0.519	22
0.520 to 0.539	13
0.540 to 0.559	8
0.560 to 0.579	6

Flock details	kg	lbs
Age (days)	28	28
Target weight	0.450	0.99
Average weight	0.446	0.98
Total birds weighed	197	197

Ideal body weight range assumed to be +/-10%.

10% of average sample weight = 0.1 x 0.446 kg (0.98 lbs) = **0.045 kg (0.099 lbs)**.

Therefore,

+10% of average weight: 0.446 + 0.045 kg (0.98 + 0.099 lbs) = **0.491 kg (1.08 lbs)**.

-10% of average weight: 0.446 - 0.045 kg (0.98 - 0.099 lbs) = **0.401 kg (0.88 lbs)**.

115 birds out of 197 weighed are within the weight range that is +/- 10% of the average body weight (0.401-0.491 kg [0.88 – 1.08 lbs]). Uniformity is therefore **58%**.

As uniformity is less than 65%, a 3-way grade is required (see table, **Grading cut-offs when using uniformity**).

In this example there are 4 pens each of the same size; 25% of the population will need to be housed in each pen, the percentage of birds in each population will therefore be 25% light, 50% average and 25% heavy.

Cut-off points and number of birds in each group:

	% of Birds	No. of Birds
Light Birds	25	49
Average Birds	50	99
Heavy Birds	25	49

The **light** graded population will be 25% of the entire flock. Of the 197 birds weighed the lightest 25% (or 49 birds) are in the weight range of 0.320 to 0.419 kg (0.71 to 0.92 lbs). A **light** bird will therefore be a bird weighing **less than or equal to 0.419 kg (0.92 lbs)**.

Using the calculation above the cut-off weights for the average and heavy populations can also be determined.

The **average** graded population will be in the weight range of **0.420 to 0.499 kg (0.92 to 1.10 lbs)**.

The heavy graded population will be any bird that is **0.500 kg (1.10 lbs) or heavier**.

Once movement of birds into each grading pen has been completed according to recommended calculated numbers/percentages and cut-off points, an adjustment to bird numbers per pen can be made (if needed), to achieve the correct stocking densities according to actual pen sizes.

If a 2-way grade is required (i.e. flock uniformity is greater than 65%), the percentage of birds in each population would be 25% light and 75% average and cut-offs weights would be determined on that basis in the same way as was done for the 3-way grade example given above.

CURRENT DATA IMPERIAL	
TOTAL WEIGHED:	197
AVERAGE WEIGHT:	0.98
DEVIATION:	0.13
C.V. (%)	<b>13.3</b>
Band limits	Total
0.705 to 0.747	4
0.750 to 0.791	7
0.794 to 0.836	10
0.838 to 0.880	12
0.882 to 0.924	16
0.926 to 0.968	14
0.970 to 1.012	27
1.014 to 1.056	30
1.058 to 1.100	28
1.102 to 1.144	22
1.146 to 1.188	13
1.190 to 1.232	8
1.235 to 1.276	6

## Appendix 5: Dew Point or Condensation Table

When eggs are moved from a cold environment to warmer, more humid conditions, they may sweat. The following table gives the shell temperature that will result in condensation when moving eggs into a wide variety of temperatures and humidities. To avoid condensation, the egg shell temperature needs to be higher than that given in the table below.

Eggs may sweat when they are transported from a cold egg store on the farm to a warm hatchery or from a cold egg store in the hatchery for pre-warming or incubation.

If eggs are sweating, they should not be fumigated or put into a cold egg store until they are dry.

The lowest temperatures (°C [°F]) in a room or setter into which eggs are being moved from an egg store at which condensation will occur.

Egg Store Temperature °C (°F)	Relative Humidity (%RH) of Room Eggs Moved Into				
	40	50	60	70	80
12 (54)	27 (81)	23 (73)	20 (68)	18 (64)	15 (59)
13 (55)	28 (82)	24 (75)	21 (70)	19 (66)	16 (61)
14 (57)	29 (84)	25 (77)	22 (72)	20 (68)	17 (63)
15 (59)	30 (86)	26 (79)	23 (73)	21 (70)	18 (64)
16 (61)	31 (88)	27 (81)	24 (75)	22 (72)	19 (66)
17 (63)	32 (90)	28 (82)	25 (77)	23 (73)	20 (68)
18 (64)	33 (91)	29 (84)	26 (79)	24 (75)	21 (70)

## Appendix 6: Calculations for Ventilation Rates

### Minimum Ventilation Calculation for Fan Timer Settings

Employ the following steps to determine the interval fan timer settings for achieving minimum ventilation.

Obtain the appropriate minimum ventilation rate as recommended in **Table 22** (page 122). The exact rates will vary with breed, sex, and for each individual poultry house. Check with the company of manufacture and local Aviagen Representatives for more specific information. The rates given in **Table 22** are for temperatures between -1 and 16°C (30 and 61°F). For lower temperatures a slightly lower rate may be required and for higher temperatures a slightly higher rate.

#### **Example (metric)**

*The assumptions on which this example calculation is based are given below. These will vary for individual circumstances.*

Bird age = 15 weeks  
 Bird weight = 1.6 kg  
 Number of birds = 10,000  
 Minimum ventilation fan = 1 x 91 cm  
 Minimum ventilation rate = 1.23 m<sup>3</sup>/hr  
 Fan capacity (cubic meters per hour or m<sup>3</sup>/hr) = 15,300 m<sup>3</sup>/hr  
 Using a 5 minute (300 second) cycle timer

**Step 1:** Calculate the total minimum ventilation rate required for the house (m<sup>3</sup>/hr).

Minimum ventilation requirement = number of birds in the house x appropriate ventilation rate

= 1.23 m<sup>3</sup>/hr per bird x 10,000 birds  
 = 12,300 m<sup>3</sup>/hr

**Step 2:** Calculate the actual ON time of the fans:

Actual ON time = (total ventilation needed ÷ total operating fan capacity) x 100

= (12,300 m<sup>3</sup>/hr ÷ 15,300 m<sup>3</sup>/hr) x 100  
 = 80%

Therefore, fans need to be run for 80% of the cycle time.

**Step 3:** Assume a 5 minute (300 second) timer is used.

Actual ON time = 80% or 0.80 x 300 seconds = 240 seconds.

So, the fans should be ON for 240 seconds, and OFF for 60 seconds.

NOTE: Cycle time = ON time + OFF time.

**Example (imperial)**

Bird age = 15 weeks  
 Bird weight = 3.53 lb  
 Number of birds = 10,000  
 Minimum ventilation fan = 1 x 36 inches  
 Minimum ventilation rate = 0.72 ft<sup>3</sup>/min  
 Fan capacity (cubic feet per minute or ft<sup>3</sup>/min) = 9,000 ft<sup>3</sup>/min  
 Using a 5 minute (300 second) cycle timer

**Step 1:** Calculate the total minimum ventilation rate required for the house (ft<sup>3</sup>/min):

Minimum ventilation requirement = number of birds in the house x appropriate ventilation rate  
 = 0.72 ft<sup>3</sup>/min per bird x 10,000 birds  
 = 7,200 ft<sup>3</sup>/min

**Step 2:** Calculate the actual ON time of the fans:

Actual ON time = (total ventilation needed ÷ total operating fan capacity) x 100  
 = (7,200 ft<sup>3</sup>/min ÷ 9,000 ft<sup>3</sup>/min) x 100  
 = 80%

Therefore, fans need to be run for 80% of the cycle time.

**Step 3:** Assume a 5 minute (300 second) timer is used.

Actual ON time = 80% or 0.80 x 300 seconds = 240 seconds.

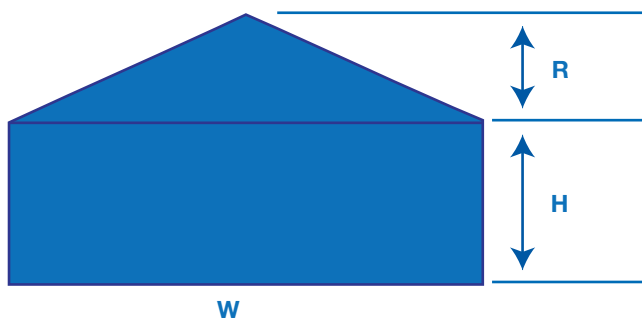
So, the fans should be ON for 240 seconds, and OFF for 60 seconds.

NOTE: Cycle time = ON time + OFF time.

**Calculation of number of fans required for tunnel ventilation**

**Example calculation (metric)**

Assumptions:  
 Bird age = 20 weeks  
 Number of birds = 10,000  
 House width (W) = 12 m  
 House height (H) = 2.4 m  
 Roof height (R) = 1.5 m



Design air speed (meters per second or m/sec) = 2.03 m/sec (rearing) & 2.54 m/sec (production)  
 Fan capacity at 0.15 inches of water column or 37.5 Pa (m<sup>3</sup>/hr) = 35,000 m<sup>3</sup>/hr  
 Conversion of seconds to hours = 3,600  
 Cross section area = (0.5 x W x R) + (W x H)

**Step 1:** Determine the fan capacity required for a given air speed (m<sup>3</sup>/hr):

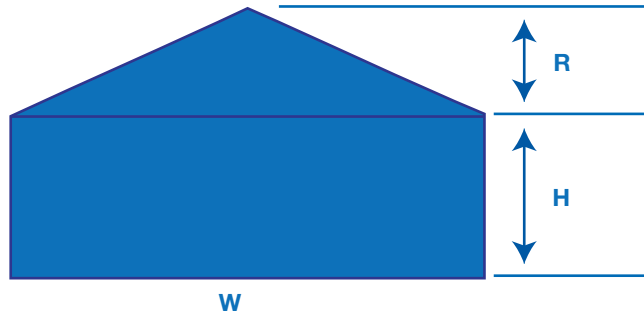
Required fan capacity = design air speed x cross section area x 3,600  
 Cross section area = (0.5 x 12 m x 1.5 m) + (12 m x 2.4 m) = 37.8 m<sup>2</sup>  
 Required fan capacity = 2.54 m/sec x 37.8 m<sup>2</sup> x 3,600  
 = 345,643 m<sup>3</sup>/hr

**Step 2:** Determine the number of fans required:

Number of fans = required fan capacity ÷ fan operating capacity  
 = 345,643 m<sup>3</sup>/hr ÷ 35,000 m<sup>3</sup>/hr  
 = 9.9 (10) fans

**Example calculation (imperial)**

Assumptions:  
 Bird age = 20 weeks  
 Number of birds = 10,000  
  
 House width (W) = 40 ft  
 House height (H) = 7.9 ft  
 Roof height (R) = 4.9 ft



Design air speed (feet per minute or ft/min) = 400 ft/min (rearing) and 500 ft/min (production)  
 Fan capacity at 0.15 inches of water column (ft<sup>3</sup>/min) = 20,585 ft<sup>3</sup>/min  
 Cross section area = (0.5 x W x R) + (W x H)

**Step 1:** Determine the fan capacity required for a given air speed:

Required fan capacity = design air speed x cross section area  
 Cross section area = (0.5 x 40 ft x 4.9 ft) + (40 ft x 7.9 ft) = 414 ft<sup>2</sup>  
 Required fan capacity = 500 ft<sup>3</sup>/min x 414 ft<sup>2</sup>  
 = 207,000 ft<sup>3</sup>/min

**Step 2:** Determine the number of fans required:

Number of fans = required fan capacity ÷ fan operating capacity  
 = 207,000 ft<sup>3</sup>/min ÷ 20,585 ft<sup>3</sup>/min  
 = 10.1 (10) fans

**Calculation for evaporative cooling cool pad area**

**Example calculation (metric)**

Assumptions:  
 Bird age = 20 weeks  
 Number of birds = 10,000  
 Pad air speed (meters per second or m/sec) = 1.91 m/sec (150 mm thick pad)  
 The house has ten 127 cm fans with a capacity of 35,000 m<sup>3</sup>/hr  
 Conversion of seconds to hours = 3,600

**Step 1:** Determine cooling pad area:

Cooling pad area = tunnel fan capacity (m<sup>3</sup>/hr) ÷ (pad air speed [m/sec] x 3600)  
 = (10 x 35,000 m<sup>3</sup>/hr) ÷ 6876 m/hr  
 = 50.9 m<sup>2</sup>

**Example calculation (imperial)**

Assumptions:  
 Bird age = 20 weeks  
 Number of birds = 10,000  
 Pad air speed (feet per minute or ft/min) = 375 ft/min (6 inch thick pad)  
 The house has ten 50 inch fans with a capacity of 20,585 ft<sup>3</sup>/min

**Step 1:** Determine cooling pad area:

Cooling pad area = tunnel fan capacity (ft<sup>3</sup>/min) ÷ pad air speed (ft/min)  
 = (10 x 20,585 ft<sup>3</sup>/min) ÷ 375 ft/min  
 = 549 ft<sup>2</sup>

## Appendix 7: Trouble Shooting - Vitamin Deficiency

Possible Cause	Problem							
	Egg Production	Fertility	Hatchability	Resistance to Disease	Feathering	Bone Deformities	Leg Weakness	Thin Shell Eggs
Vitamin A	X		X	X	X		X	
Vitamin D3	X		X			X		X
Vitamin E	X	X	X	X				
Vitamin B12	X		X					
Riboflavin			X	X			X	
Niacin					X	X		
Pantothenic Acid			X	X	X			
Choline	X					X		
Vitamin K								
Folic Acid	X		X		X	X		
Thiamin B1								
Pyridoxine B6	X		X					
Biotin	X	X	X		X	X	X	



# Appendix 8: Nutrient Composition of Some Commonly Used Feed Ingredients (Per Kg)

	CP	Energy (ME)		Arginine		Iso-Leucine		Lysine		Methionine		Meth & Cyst		Threonine		Tryptophan		Ca	Av.P	Na	Cl	K	Choline	Linoleic Acid	Dry Matter
		MJ	kcal	T	A	T	A	T	A	T	A	T	A	T	A	T	A								
Barley	107	11.7	2790	5.4	4.5	3.7	3.0	3.8	3.0	1.8	1.4	4.2	3.4	3.6	2.7	1.2	0.9	0.6	1.4	0.1	1.0	4.8	990	8.6	880
Maize	87	13.7	3275	4.1	3.8	3.0	2.7	2.4	2.2	1.8	1.7	3.7	3.3	3.1	2.7	0.6	0.5	0.3	0.9	0.1	0.5	3.6	620	18.8	880
Wheat	119	12.7	3020	5.6	5.0	3.9	3.5	3.3	2.7	1.9	1.7	4.6	4.0	3.4	2.8	1.4	1.2	0.7	1.3	0.1	0.4	4.2	1000	6.8	880
Sorghum	101	13.5	3215	4.0	3.4	4.0	3.3	2.3	1.8	1.5	3.6	3.0	3.4	3.4	2.6	1.1	0.9	0.4	0.9	0.1	0.7	3.8	660	12.2	880
Oats	112	11.0	2620	7.5	7.1	4.2	3.7	4.8	4.2	1.9	1.7	5.1	4.3	3.9	3.3	1.3	1.1	1.1	1.7	0.1	0.7	4.7	950	16.8	880
Maize Gluten Feed	209	8.0	1915	9.5	8.3	6.7	5.5	6.7	4.8	3.6	3.1	8.9	6.4	7.7	5.9	1.2	1.0	1.2	3.7	2.4	2.1	12.6	1510	17.2	890
Maize Gluten Meal	607	14.9	3565	19.5	18.8	25.1	24.1	10.3	9.3	14.5	14.1	25.5	23.7	21.0	19.6	3.2	3.1	0.4	1.8	0.1	0.5	1.6	330	16.3	890
Wheat Feed/Middlings	156	7.6	1825	9.5	8.2	5.2	4.1	5.6	4.6	2.6	2.0	5.7	4.3	5.0	3.7	1.9	1.5	1.0	2.9	0.3	0.3	13.7	1440	14.0	870
Wheat Bran	150	6.2	1475	10.1	7.8	4.6	3.5	6.0	4.4	2.3	1.7	5.5	4.0	4.9	3.6	2.1	1.4	1.9	3.5	0.4	1.3	12.5	1230	14.0	870
Rice Bran Raw	129	9.9	2370	10.3	8.9	4.4	3.7	6.0	4.8	2.7	2.2	5.6	4.7	5.0	4.1	1.6	1.2	1.0	2.5	0.1	0.4	10.6	1130	38.5	890
Rice Bran Ext.	147	6.8	1610	11.6	10.0	5.2	3.8	6.5	4.8	3.2	2.5	6.4	4.5	5.9	4.1	1.7	1.3	1.4	2.8	0.2	0.7	12.1	1230	3.6	890
Field Beans (White)	300	11.2	2685	28.6	26.6	11.8	10.1	18.8	16.5	2.3	1.8	5.9	4.6	10.1	8.9	1.7	1.4	1.1	2.3	0.2	0.7	13.4	1670	5.2	870
Peas	227	11.4	2715	21.4	19.7	8.8	8.0	15.7	13.5	2.3	1.9	5.6	4.2	8.1	6.9	2.0	1.6	1.1	1.8	0.1	0.6	11.0	642	4.0	870
Soybeans, Heated	356	14.4	3450	26.3	22.9	16.2	14.1	22.4	19.3	5.4	4.7	10.9	9.2	14.2	12.1	4.9	4.2	2.3	2.2	0.1	0.3	17.6	2860	97.0	880
Soybean Meal, 48	473	9.3	2230	34.6	32.2	21.3	19.5	29.3	26.7	6.8	6.3	13.8	12.1	18.6	16.6	6.1	5.2	2.7	2.7	0.2	0.3	22.6	2730	7.0	870
Sunflower Meal, 39	386	6.7	1600	33.3	31.6	16.3	15.0	13.8	12.0	9.2	8.5	16.1	14.2	14.6	12.7	4.8	4.1	3.7	2.9	0.3	1.2	14.7	2890	6.8	900
Rape/Canola Meal	343	7.1	1700	20.8	18.7	13.4	11.4	19.2	15.4	6.9	6.1	15.6	12.7	15.1	12.1	4.5	3.7	7.3	3.6	0.3	0.3	12.6	6700	3.1	880
Fish Meal 66	660	13.6	3250	38.1	35.0	27.4	25.2	51.4	45.7	18.9	17.0	24.8	21.6	28.0	25.2	7.0	6.2	34.9	17.6	10.3	15.8	10.0	3050	0.1	910
Herring Meal	706	14.1	3360	40.4	37.1	30.0	27.6	56.3	50.1	20.7	18.6	27.0	23.5	30.5	27.4	7.8	7.0	26.4	15.5	10.3	16.2	13.9	5300	0.1	910
Meat and Bone Meal	538	12.6	3000	37.7	29.4	16.1	12.9	29.6	22.5	8.1	6.6	14.0	9.9	18.8	14.0	3.6	2.5	73.3	22.6	7.6	6.3	4.8	1900	8.1	940

**Notes**

T=Total amino acid content; A=Available amino acid content

These data are given as a guide to feed formulation. Local information on the actual quality of available ingredients should always be used in preference.

Data are based on information published by Degussa AG; CVB, Netherlands; National Research Council, USA.

Meat and Bone Meal is a very variable product and is increasingly excluded from breeder feeds on the grounds of biosecurity. Data relate to a sample with 54% protein, 14% fat and 23% ash.

# Keyword Index

- Activity 7, 11, 24, 61, 67-68, 79, 90-92, 95-97, 123, 125, 133, 143, 154, 164
- Adjustable penning 39-41, 46-47
- Air flow 11, 47, 111, 115-116, 118-120, 124, 126-128, 130
- Air inlet 111, 113, 116-121, 124-126, 131, 134, 156
- Air leakage 111, 117
- Air quality 11, 26, 28, 123-124
- Air speed 12, 26, 118-119, 122, 127-128, 130, 132, 181-182
- Air tightness 111, 113
- Airborne disease 110
- Alertness 10, 12, 90-91, 97
- All in/all out 18, 19, 154, 162
- Amino Acids 37, 143, 145, 147-148, 150
- Antibiotics 164
- Antibody 162-163, 165-166
- Anti-nutritional factors 149
- Automated feeding 31, 32, 34
- Automatic weigh scale 83
- Bacterial counts 35, 105, 107, 150, 158-159, 168
- Behavior 7, 10-13, 17, 21, 24-28, 36-37, 54-56, 59, 67-69, 113, 122-125, 127-128, 132, 134, 148
- Biofilms 157
- Biosecurity 7, 18-20, 35, 53, 109-110, 112, 153-166, 184
- Bird condition 9, 89-90, 92-93, 99
- Bird distribution 10-11, 27, 32, 34
- Blackout 111, 115, 133, 136-137
- Body condition 12, 63-64, 67-68, 79, 89-95, 97-98, 144
- Body weight 7-9, 15-17, 33, 38-45, 47, 51-52, 56, 58, 60-61, 63-64, 67-68, 71-79, 81, 84-87, 89-92, 94-95, 97-98, 100, 111, 123, 133-137, 139-140, 143-144, 147, 150-151, 167-168, 174-176, 178
- Body-weight profile 8, 16, 43-44, 51-52, 60, 90, 98, 135-137, 140-142
- Body-weight recording 85, 174-176
- Body-weight targets 8, 43-44, 143
- Breast shape 89, 92-93
- Brooding 7, 17-18, 20-29, 34-35, 90, 97, 114, 117, 119, 133, 135, 137, 139
- Bulk weighing 7, 65, 83
- Calcium 60, 131, 145-146, 148, 151, 157-158, 160
- Chick placement 7, 17-18, 29-30, 39
- Chick transport 17, 18, 30
- Chloride 105, 145, 160
- Chlorination 35, 159, 163
- Cleaning soiled eggs 105-106
- Coccidiosis 153, 162, 164
- Coefficient of variation 39, 85-86, 162, 174
- Coliforms 150, 159-160
- Comb 54-57, 67-68, 91, 95
- Condensation 103, 106-108, 179
- Contaminated feed 164
- Controlled environment housing 110, 116, 133, 134
- Conversion tables 171
- Critical age objectives 7
- Crop fill 7, 10, 16, 28-30, 53-54
- Crumb 12, 20, 28, 33-34, 64, 147
- CT 92-93, 99
- Curtains 114-115, 117, 136, 155-157
- CV% 8-9, 16, 33, 38-43, 60, 81-83, 85-87, 97, 134-135, 137, 139, 167, 175, 177
- Daylength 7, 24, 45, 53, 109, 111, 132-141
- Dead bird disposal 161
- Dew point 107, 179
- Diet formulation 148
- Direction plates 119
- Dirty eggs 104, 108
- Disease 13, 17, 19, 26, 38, 60, 87, 97, 108, 110, 113-114, 146, 149, 153-155, 158, 161-165, 168, 183
- Disinfection 19, 23, 101, 104-107, 111, 153-158, 168
- Disposal of dead birds 161
- Distribution curve 38
- Downtime 154, 158, 163
- Drainage 110, 161
- Drinker height 47, 61
- Drinker space 29, 34, 37, 49-51, 60, 63, 167, 169
- Drinkers 7, 11, 20-24, 30-31, 34-36, 53, 90, 117, 125, 155, 169
- Dust 10, 20, 64, 103, 113-114, 155-156, 165
- Egg collection 104, 106-107
- Egg contamination 103
- Egg cooling 103
- Egg disinfection 104-105
- Egg packing 104
- Egg packing and selection 104
- Egg production 9, 11, 16, 49, 51, 56, 60, 63-64, 67-69, 71-72, 78, 89, 97-98, 100, 111, 127, 133, 135, 137, 139, 141, 145, 147-148, 151, 164-165, 168, 183
- Egg storage 105-108
- Egg temperature 106
- Egg weight 9, 16, 63-67, 71-78, 97-98, 133-134, 167-168
- Electronic scales 39-40, 82, 86, 174
- ELISA 165-166
- Energy 37, 45, 51-52, 63-64, 72-73, 78, 100, 127, 143-149, 151, 171, 184
- Environment 7, 10-12, 17-18, 23-25, 28, 30-31, 37, 49, 63-64, 78, 106, 109-111, 113-114, 116, 121, 128, 130-137, 139, 157, 161, 163, 165, 179
- Evaporative cooling 24, 115, 127-132, 157, 182
- F value 85
- Fans 11, 47, 106, 111, 114-121, 123-132, 156-158, 180-182
- Farm design 110
- Fat pad 99-100
- Fats 148-149
- Feathering 12, 56, 69, 72, 91, 96, 145, 183
- Feed allocation 8, 23, 42-43, 46, 63-64, 72, 79, 86, 91, 98, 143
- Feed bin 34, 112, 146, 149-150, 157-158
- Feed clean-up time 9, 60, 63-64, 72, 74-75, 78, 144, 162

- Feed hygiene 150, 164  
 Feed level 40, 42-44, 51, 53, 63, 72, 75-78, 92, 143, 147, 149  
 Feed manufacture 149  
 Feed quality 10-11, 34, 64, 146-147, 150  
 Feed sample 94, 150  
 Feed specifications 147  
 Feed systems 18, 156  
 Feed texture 64, 72  
 Feeder height 33, 46-47, 59, 92  
 Feeder space 7-8, 30, 32, 49, 53, 61, 90, 97, 167, 169  
 Feeding behavior 54-56, 59, 67-68  
 Feeding equipment 56-58, 110, 147, 157  
 Feeding management 32, 47, 97, 143, 147, 149-150  
 Feedstuffs 149  
 Feel 10-12, 89, 93, 99, 120, 124-127  
 Feet 12, 17, 89, 91, 95, 97, 128, 171-173, 181-182  
 Fertility 16, 49, 51, 56, 67-69, 71, 78-79, 89-92, 95, 97, 100, 142, 145, 148, 151, 164, 167-168, 183  
 Filter 129, 159  
 Fines 34  
 First egg 9, 15, 60-61, 63, 97  
 Five freedoms of animal welfare 12-13  
 Fixed penning 41-42, 177-179  
 Fledding 12, 16, 60, 63, 68, 79, 89-93, 95, 97-100, 145  
 Floor eggs 36, 61-62, 104, 108, 127, 135-136, 167  
 Floor feeding 20, 33-34, 37, 47, 150  
 Floor space 24, 31, 39, 49, 51  
 Fogging 127, 131-132, 157  
 Footpad 79, 91, 95  
 Formaldehyde 104-105, 107  
 Formalin 105, 157  
 Fumigation 104-105, 107, 155, 157  
 Gating 8, 16-18, 38-44, 46, 174-178  
 Grill 57-59, 156-157  
 Grower feed 147  
 Growth 8, 11, 15-16, 20, 23, 33, 43, 63, 71-72, 79, 81-89, 97, 101, 106-107, 114, 144, 146-149, 159-160  
 Handling 9, 12, 17, 81, 90, 97, 162-163  
 Hard water 131, 159  
 Hatchability 63, 69, 78, 100-101, 105, 107-108, 145, 147, 149, 151, 167-168, 183  
 Hatching eggs 71, 101-108, 149  
 Head 26-27, 49-50, 56-57, 69, 91, 95, 100, 135-137  
 Health monitoring 165-166  
 Hearing 10  
 Heat treatment 150, 164  
 Heating equipment 111  
 Heavy birds 40-41, 175-178  
 Helminth 164  
 House cleaning 18, 20, 111, 159, 163  
 House design 39, 109, 111-112, 127, 155  
 Humidity 7, 16-17, 19, 23-27, 101, 107, 109, 113-115, 118, 124, 127-128, 130-132, 146, 157, 167, 179  
 Hygiene 18-19, 61, 107, 150, 153-154, 158, 162, 164  
 Immunological response 162  
 Incineration 161  
 Infection 95, 150, 153, 163-165  
 Inlets 11, 47, 111, 113-114, 116-121, 123-126, 131-132, 134, 156  
 In-season flocks 141-142  
 Insect control 155  
 Insulation 111-112, 173  
 Keel bone 93-94, 99-100  
 Laboratory analysis 143, 163  
 Lamp type 142  
 Legs and feet 89, 91, 95, 97  
 Light birds 40-41, 175-178  
 Light leakage 134, 136  
 Light spectrum 142  
 Lighting 9, 15, 24, 37, 52-53, 60-61, 64, 110-112, 133-142, 168  
 Lighting programs 52-53, 60, 64, 133-139, 141  
 Limestone 145  
 Litter 7, 10-12, 18-20, 23-29, 33, 35, 37, 47, 59, 79, 91, 104, 113, 115, 118, 131, 145, 153-157, 163, 165  
 Male feeding 58-59, 148  
 Managing to condition 89-97  
 Manometer 117  
 Manual feeding 32  
 Marek's disease 153, 162, 164  
 Mash 34, 37, 64, 72, 145, 149-150  
 Mating 9-12, 15-16, 54-57, 61, 67-69, 79, 86, 91-92, 95-96, 123, 142, 167, 170  
 Mating ratios 9, 61, 68-69, 79, 91, 170  
 Maturity 9, 12, 15-16, 49, 51-52, 54, 57, 60-61, 67, 89-91, 100, 111, 134-137, 139-141, 147  
 Metabolic disorders 146  
 Migration 126  
 Minerals 37, 110, 144-146  
 Misting 131-132  
 Monitoring 10, 25-28, 30, 45, 51, 54, 56, 60, 63-64, 67, 72, 74, 76, 78-79, 81-90, 92, 97-99, 113, 117, 127, 147, 150, 158, 164-166  
 Monitoring body 74, 92, 98  
 Mycoplasma 163, 165-166  
 Mycotoxin 146, 149, 153  
 Natural environment 133, 136  
 Nests 60-62, 104, 108, 128  
 Normal distribution 38  
 Nutrient composition 143, 145-146, 184  
 Nutrient intake 65, 143-144  
 Nutrient recommendations 145  
 Oils 149  
 Open-sided housing 110-111, 114, 133, 137, 139-140, 156  
 Operating temperature 148, 173  
 Out-of-season flocks 137, 141-142  
 Over-mating 61, 69  
 Overweight birds 52  
 Pad cooling 129-130, 132  
 Pan feeder 31-33, 46, 58  
 Pathogens 7, 109, 149, 154-155, 157, 159, 163, 165  
 Peak production 9, 49-69, 71-72, 78-79, 89, 100  
 Pellet 12, 20, 33-34, 47, 64, 72, 145, 150  
 Pen size 42, 47, 177-178  
 Perches 36, 61, 155  
 Perimeter 19, 109, 154  
 Persistence 51, 67, 69, 71, 75, 77-79, 89, 91, 100, 135, 137, 139, 145

Pest management	154	Synchronization	51, 135-136
Phosphorus	145, 148	Target parameters	168
Photorefractory	133-134, 139	Target performance	72, 167
Photostimulation	15-16, 133-134, 139-140	Target weight	8, 16, 40-45, 51-52, 67-68, 83, 85, 87, 100, 134, 142, 174, 177-178
Physical assessment of bird	89	Taste	10
Phytase	146	Temperature	7, 10-11, 16-17, 19-30, 36-37, 47, 53, 63-64, 68, 72, 78, 101, 104-107, 109, 111-117, 119, 122-132, 143-144, 146, 148, 150-151, 157, 161, 167, 172-173, 179-180
Pin bones	60, 97-98	Temperature gradient	22, 25
Placement	7, 17-20, 23-24, 28-30, 37-39, 83, 89-90, 133, 138, 141, 154, 163	Three essentials of stockmanship	12
Platform scales	82, 87	Timer	115, 118, 120, 123-124, 180-181
Post-peak management	71	Toast rack	57
Potassium	145, 160	Trace minerals	37, 146
Power availability	110	Track feeder	31-32, 47, 54
Pressure	11, 111, 113, 116-120, 123-125, 128, 131, 150, 155-157, 172	Transitional ventilation	116, 124-126
Protein	37, 72, 102-103, 145, 147-148, 151, 164, 184	Tube feeders	58-59
Quality control	146, 150-151	Tunnel ventilation	111, 115-116, 124-130, 132, 181
Random sample	40, 53, 174	Underfeeding	67, 73
Raw material	34, 149, 164	Underweight birds	8, 51
Rear	15, 30-31, 36-37, 42, 45-46, 53-54, 84, 90, 97-98, 111, 133-134, 136-138, 140, 151	Uniformity	8-9, 16-17, 23, 29-33, 38-43, 49, 51-52, 56, 58-60, 68, 79, 81, 90, 94-95, 97, 134-137, 139-140, 143, 147, 150, 167, 176, 178-179
Rear and move	36, 53, 136	UV	105, 142
Recirculation fans	115	Vaccination programs	153, 162-163, 166
Records	11-12, 81, 162-164, 166-168	Vehicle cleaning	19
Regulations	17, 49, 105, 109-110, 156, 162	Vent (cloaca)	96
Relative humidity	7, 17, 19, 114-115, 118, 124, 127-128, 130-132, 157, 179	Ventilation	7, 11-12, 16-17, 26-29, 31, 37, 47, 49, 51, 109-130, 132, 140, 155-157, 163, 173, 180-181
Removal of males	69	Ventilation calculations	128
Rendering	157, 161	Visitors	154
Repairs and maintenance	157	Vitamin potency	146
Respiratory disease	26, 108, 113-114	Vitamins	144, 146-147, 150
Rodent	112, 149, 154-155	Vocalization	10-11, 28
Rots and bangers	108	Walk-through	63, 89-90
Salmonella	158, 163-165	Washing eggs	106-107
Sample weighing	42, 81, 83-84, 86-87, 97, 176	Washing houses	18
Sanitize	154, 159	Water	7, 10-12, 16, 18-21, 23, 28-29, 34-37, 47, 53-54, 60, 102, 106-107, 110, 113, 115, 117, 128-131, 133, 145-146, 151, 153-154, 156-164, 167, 181-182
Seasonal variation	140	Water quality	35, 131, 151, 159-161
Sediment	159	Water:feed ratio	167
Sensors	26, 127	Wattles	54-56, 67-68
Separate sex feeding	54	Wavelength	142
Serological monitoring	165	Weigh scales	42, 87
Sexing errors	8-9, 54-56, 167	Weight profile	8, 16, 43-44, 51-52, 60, 65, 78, 90, 98, 135-137, 140-142
Sexual maturity	9, 12, 15-16, 49, 51-52, 54, 60-61, 89-91, 100, 134-137, 139-141, 147	Welfare	10-13, 17, 23, 30, 37, 49, 54, 69, 81, 95, 109, 111, 113, 132, 134, 143-144, 149, 153, 155, 157, 161-162, 164-165
Shank length	90, 97	Whole-house brooding	22, 24-25, 28
Shell quality	71, 108, 145, 149, 151	Wind chill	126-127
Sight	10	Wind speed	126
Site	18, 109-111, 150, 154-156, 158, 162	Worm	164
Site cleaning	154-155, 158		
Skeleton	15-16, 90		
Smell	10-12, 34, 114		
Sodium	37, 145, 151, 160		
Spin feeders	33, 47		
Spot brooding	21, 25, 27-28		
Spray cooling	129		
Standard deviation	175		
Starter feed	45, 147		
Stock sense	10, 12		
Stocking density	21, 24, 30-31, 37, 40, 42, 46-47, 49, 51, 60, 63, 111-112, 115, 127, 153, 167, 169, 172, 177-178		
Stockman	10, 11, 12, 89		
Stockmanship	10-14, 37, 89		
Sudden Death Syndrome	146		



Every attempt has been made to ensure the accuracy and relevance of the information presented. However, Aviagen accepts no liability for the consequences of using the information for the management of chickens.

For further information on the management of Ross stock, please contact your local Ross representative.

Aviagen and the Aviagen logo, Ross and the Ross logo are trademarks of Aviagen in the US and other countries. All other brands and trademarks are the trademarks of their respective owners.